

# Catalogo 2011

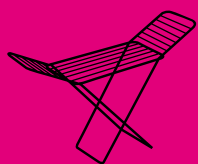

# Indice per categoria

## Stendibiancheria a cavalletto

### X legs clothes dryer

### Wäschetrockner mit gekreuzten Beinen

### Séchoirs horizontaux

### Tendedero horizontal

Aster	p. 11
Cucciolo	p. 20
Jolly	p. 5
Max Inox	p. 12
Mito	p. 15
Perla	p. 22
Plast	p. 5
Plus	p. 8
Rainbow	p. 9
Rainbow Color <b>NEW</b>	p. 9
Rocky	p. 10
Tempo	p. 16
Tempo Color <b>NEW</b>	p. 17
Tempo Super	p. 18
Tender	p. 13
Tender Color <b>NEW</b>	p. 14
Top	p. 6
Top Super	p. 7
Zaffiro	p. 21

## Stendibiancheria estensibili e multifunzione

### Extensible and multi-functional clothes dryer

### Verlängerbarer und vielseitiger Wäschetrockner

### Séchoirs extensibles et multifonctions

### Tendederos extensibles y multifunción

Alablock Extend	p. 25
Albatross	p. 28
Brezza Extend	p. 26
Dinamik 20	p. 32
Dinamik 30	p. 33
Dinamik 30 Color <b>NEW</b>	p. 34
Duplo	p. 35
Extension	p. 30
Stendissimo	p. 27

## Stendibiancheria a torre

### Tower clothes dryer

### Wäscheturm

### Séchoir tour

### Tendedero torre

Modular 3	p. 38
Modular 4	p. 39
Vip 3	p. 37
Vip 4	p. 37

## Stendibiancheria da balcone, vasca e termosifone

### Balcony, bath and radiator - clothes dryer

### Balkon-, Badewannen- und Heizungswäschetrockner

### Séchoirs balcon, baignoire et radiateur

### Tendederos de balcon, de bañera y de termosifón

Airy	p. 50
Alablock	p. 47
Brezza 60	p. 42
Brezza 100	p. 42
Brezza 100 Alu	p. 43
Brezza 100 Inox	p. 43
Brezza 200	p. 43
Ghibli	p. 44
Lampo	p. 49
Mistral	p. 41
Pallino	p. 48
Pliko	p. 51
Polar	p. 41
Quick	p. 49
Ring	p. 46
Virgola	p. 45

## Stendibiancheria da parete e soffitto

### Wall and ceiling clothes dryer

### Wand und Decken Wäschetrockner

### Séchoirs de paroi et pour plafond

### Tendederos de pared y de techo

Brio Super	p. 55
Lift	p. 58
Rotor 1	p. 53
Rotor 4	p. 54
Rotor 6	p. 54
Skatto	p. 56
Telepack	p. 57
Unix	p. 59

## Stendibiancheria da giardino

### Garden - clothes dryer

### Gartenwäschetrockner

### Séchoirs pour jardin

### Tendederos de jardin

Garden	p. 61
--------	-------

## Accessori per stendere

### Hanging accessories

### Zubehör zum Wäschetrockner Hängen

### Accessoires pour séchoir

### Accesorios para tender

Cigno	p. 65
Cover 400	p. 66
Goccioline	p. 63
Soffio	p. 64
Tendy	p. 67

## Assi da stiro

### Ironing boards

### Bügeltische

### Planches a repasser

### Tablas de planchar

Advance 100 <b>NEW</b>	p. 85
Advance 120 <b>NEW</b>	p. 86
Advance 140 <b>NEW</b>	p. 87
Andy <b>NEW</b>	p. 72
Classic	p. 74
Eden	p. 77
Golden	p. 81
Junior	p. 73
Leo <b>NEW</b>	p. 70
Mitiko	p. 82
Poker	p. 80
Pollicino	p. 69
Prestige	p. 76
Prisma	p. 83
Roy <b>NEW</b>	p. 71
Temper	p. 79
Trim	p. 75
Uniko	p. 78

## Accessori per stirare

### Ironing-accessories

### Bügelzubehö

### Accessoires pour table à repasser

### Accesorios para planchar

I Love Gimi	p. 90
Joker	p. 89
King Aluminium	p. 89
Planet	p. 103
Stiro Fast <b>NEW</b>	p. 98
Stiro Soft <b>NEW</b>	p. 99
Stiro Strong <b>NEW</b>	p. 97
Stiro Top <b>NEW</b>	p. 100
Wrappy	p. 102

## Carrelli portaspesa e portatutto

### Shopping trolleys and multi-functional trolleys

### Einkaufsroller und Transportroller

### Poussettes de marché et Chariot

### porte-charge (multifonctions)

### Carro de compra y carro multiuso

Alex	p. 121
Argo	p. 106
Atos	p. 120
Bella	p. 105
Brava	p. 105
Easy	p. 108
Extro	p. 110
Family	p. 111
Fly School	p. 118
Four 4	p. 116
Ideal	p. 109
Market	p. 112
My Porter	p. 113
Tris	p. 114
Ulysse	p. 115

## Sgabelli

### Step-ladder

### Tritt - Leiter

### Escabeaux

### Taburete

Dune	p. 127
Super Tiko	p. 124
Tiko	p. 123

## Le idee

### Ideas

### Ideen

### Les ideas

### Las ideas

Ap-lik	p. 137
Bingo	p. 132
Bingo Crystal	p. 134
Bingo Ministick	p. 135
Bingo Pocket	p. 136
Bingo Stick	p. 135
Carlotta	p. 129
Paco	p. 130
Super Bingo Crystal	p. 134
Super Paco	p. 131

## Portarifiuti

### Waste management system

### Abfallsammler

### Poubelle "porte-sachet"

### Contenedor de basuras selectivas

Nature	p. 140
Nature Plus	p. 139

# Stendibiancheria a cavalletto

# Plast

## Senza prolunghe!

**Perché** Perfetto anche per interni

## No extensions!

**Why** Perfect also for indoors

## Ohne Verlängerungsstücke!

**Merkmale** Perfekt auch für Innenräume



## Sans rallonges!

**Pourquoi** Idéal à l'intérieur aussi

## ¡Sin extensiones!

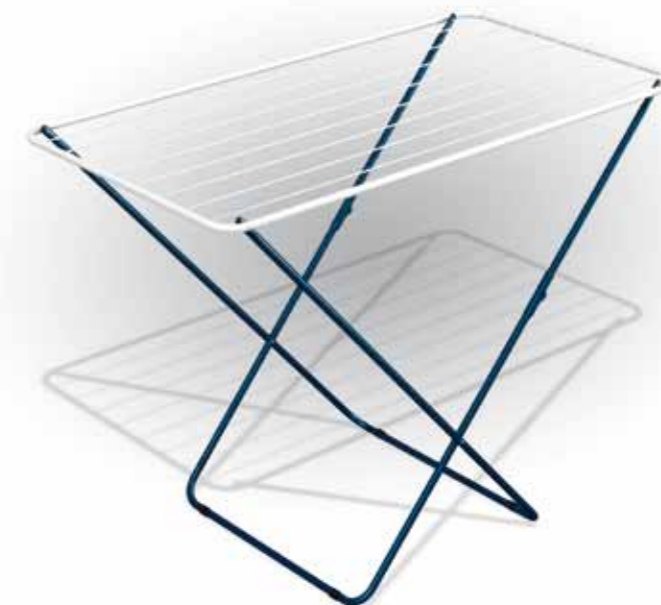
**Porqué** Perfecto también para interiores



Materiale Material		Nome prodotto Item	Plus			
			Esclusiva Gimi Gimi exclusive	Accessori* Accessories*	Rivestimenti particolari** Special coverings**	Altro Other
Acciaio Steel	m 10	Plast			✓	
	m 18	Jolly			✓	
	m 20	Top			✓	
		Top Super		✓	✓	
Acciaio/acciaio zincato Steel/ zincplated steel	m 20	Rainbow		✓	✓	
		Rainbow Color			✓	
Acciaio zincato Zincplated steel	m 20	Rocky			✓	chiusura antiribaltamento safety closing system
		Plus		✓	✓	chiusura antiribaltamento safety closing system
Acciaio/acciaio inox Steel/stainless steel	m 18	Aster				chiusura antiribaltamento safety closing system
Acciaio inox/ alluminio Stainless steel/ aluminium	m 20	Max Inox	✓	✓		chiusura antiribaltamento safety closing system
Acciaio/alluminio Steel/aluminium	m 20	Tender				chiusura antiribaltamento safety closing system
		Tender color		✓		chiusura antiribaltamento safety closing system
		Mito	✓	✓	✓	apertura free-space free-space opening
Alluminio Aluminium	m 20	Tempo	✓	✓		chiusura antiribaltamento safety closing system
		Tempo color	✓	✓		chiusura antiribaltamento safety closing system
	m 25	Tempo Super	✓	✓		chiusura antiribaltamento safety closing system miniprolonghe estraibili telescopic mini-extensions
Resina Resin	m 10	Cucciolo				larghezza 50 cm width 50 cm
	m 20	Zaffiro	✓	✓		
		Perla		✓	✓	

# Jolly

## Prolonghe più piccole!

**Perché** Per stendere tanto bucato in meno spazio

## Kleinere Verlängerungsstücke!

**Merkmale** Hier kann mehr Wäsche auf kleinerem Raum aufgehängt werden

## ¡Extensiones más pequeñas!

**Porqué** Para tender mucha ropa en un espacio mínimo

## Shorter extensions!

**Why** To hang out a lot of washing in less space

## Rallonges plus petites!

**Pourquoi** Pour étendre beaucoup de linge en moins d'espace

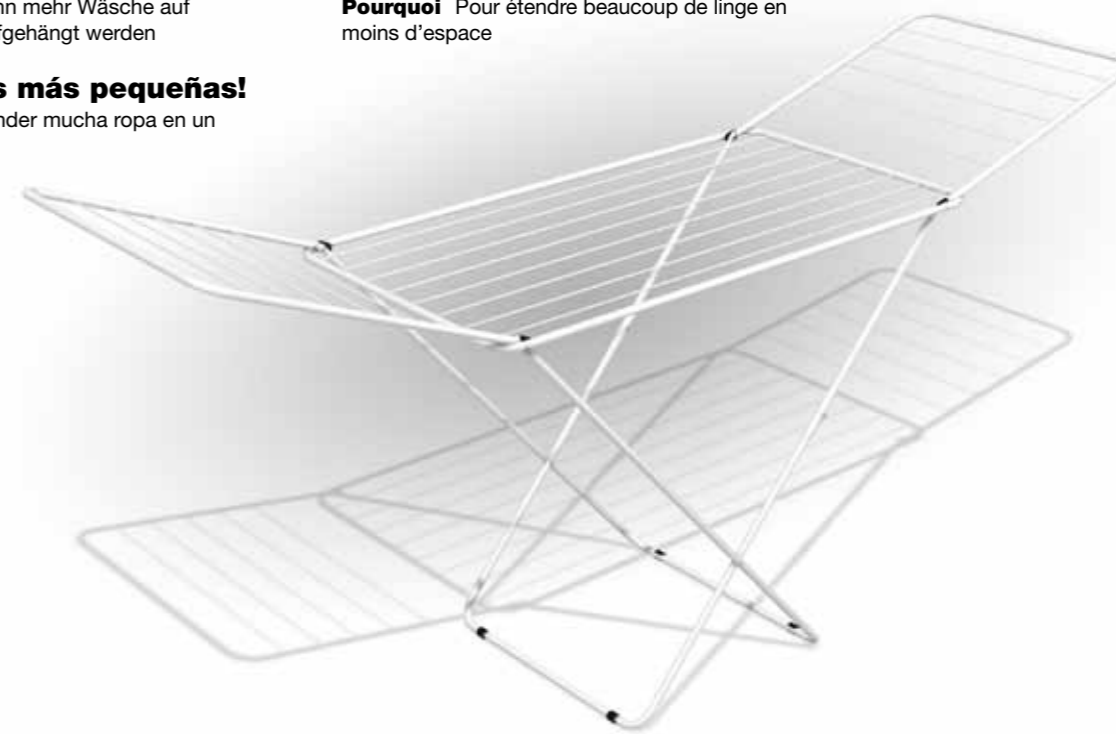

 = Nitrogen Technology

\*Per esempio: ruote gommate, portamollette, stendi fazzoletti  
For instance: rubber wheels, clothes peg holder, handkerchiefs hangers

\*\*Per esempio: verniciatura epossidica, elettrozincatura  
For instance: extra powder coating, galvanization

Per descrizioni dettagliate consultare le pagine dei singoli prodotti.  
For more details please see the related product pages.



Item	Gimi	Ean	m	1 pz	kg	axbxc=cm	axbxc=cm	axbxc=cm	n° pz	n° pz	h=cm	n° pz
Plast	10620000	8001244106109	10	2,05	10	105x55x93	55x3x129	59x12,5x133	6	72	148	61
Jolly	10390000	8001244400030	18	2,65	17	180x55x93	55x4x129	58x16x131	6	60	146	49

# Top

## Intramontabile: il preferito da sempre!

**Categoria** Acciaio trattato con polveri epossidiche  
**Dove** Per ogni tipo di ambiente, esterno e interno  
**Quanto** 20 m  
**Perché** Il mix perfetto di essenzialità, qualità e convenienza

## Evergreen: always the favourite!

**Category** Steel treated with epoxy powders  
**Where** For any kind of environment, indoors or out  
**What size** 20 m  
**Why** The perfect combination of essentiality, quality and value for money

## Zeitlos: Schon immer bevorzugt!

**Material** Stahl, epoxidpulverbeschichtet  
**Standort** Jede Umgebung, sowohl außen als auch innen  
**Leinenlänge** 20 m  
**Merkmale** Perfekter Mix aus Sachlichkeit, Qualität und Wirtschaftlichkeit

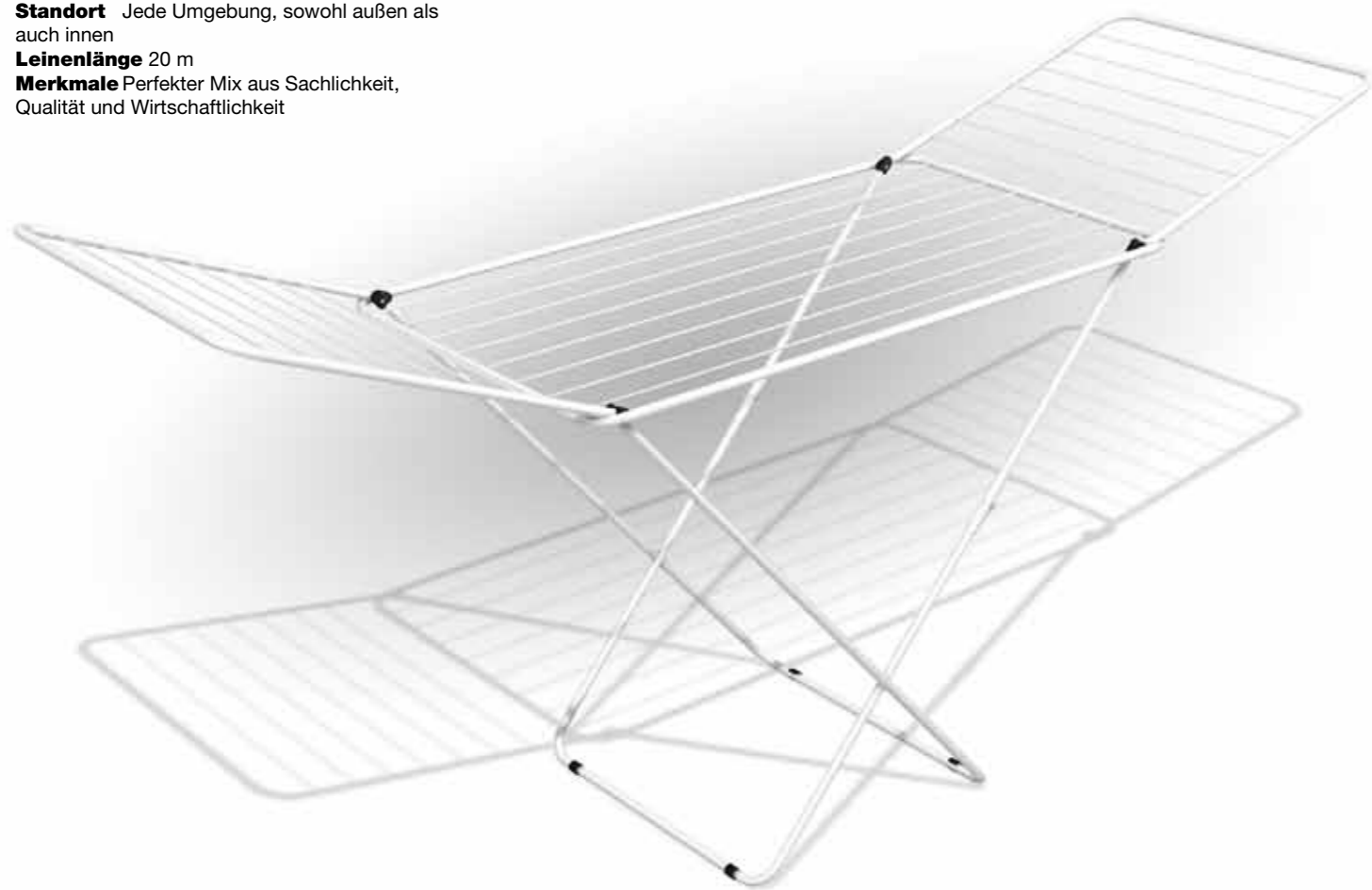

## Indémorable: le favori depuis toujours!

**Catégorie** Acier traité par des poudres époxy  
**Où** Pour n'importe quelle pièce. Aussi bien à l'intérieur qu'à l'extérieur  
**Combien** 20 m  
**Pourquoi** Une union parfaite d'essentiel, qualité et avantage

## ¡No pasa nunca de moda: el preferido desde siempre!

**Categoría** Acero tratado con polvos epoxídicos  
**Dónde** Para todo tipo de ambiente, externo e interno  
**Cuánto** 20 m  
**Porqué** la combinación perfecta de esencialidad, calidad y conveniencia

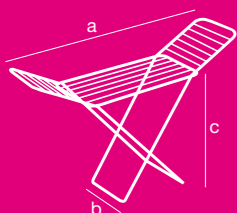

Item	Gimi	Ean	m	1 pz	kg	Aperto Open		Chiuso Folded		n° pz	n° pz	h=cm	n° pz
						axbxc=cm	axbxc=cm	axbxc=cm	axbxc=cm				
Top	10790000	8001244108639	20	2,80	17	201,5x55x93	55x5x129	60x18,5x131	6	48	146	41	

# Top Super

## Superaccessoriato!

**Perché** Completo di guarnizioni antigraffio in resina e ruote per sposterlo comodamente. Coprifestata dei fili per il massimo della protezione dalla ruggine

## Super Zubehör!

**Merkmale** Mit Antikratzbelägen in Kunstharz und Rollen zur leichten Verschiebung auf dem Boden. Ummantelte Drähte zum maximalen Rostschutz

## Too many accessories to mention!

**Why** Complete with scratchproof resin seals and wheels to make it easy to move around. Line end covers, for the greatest protection against rust

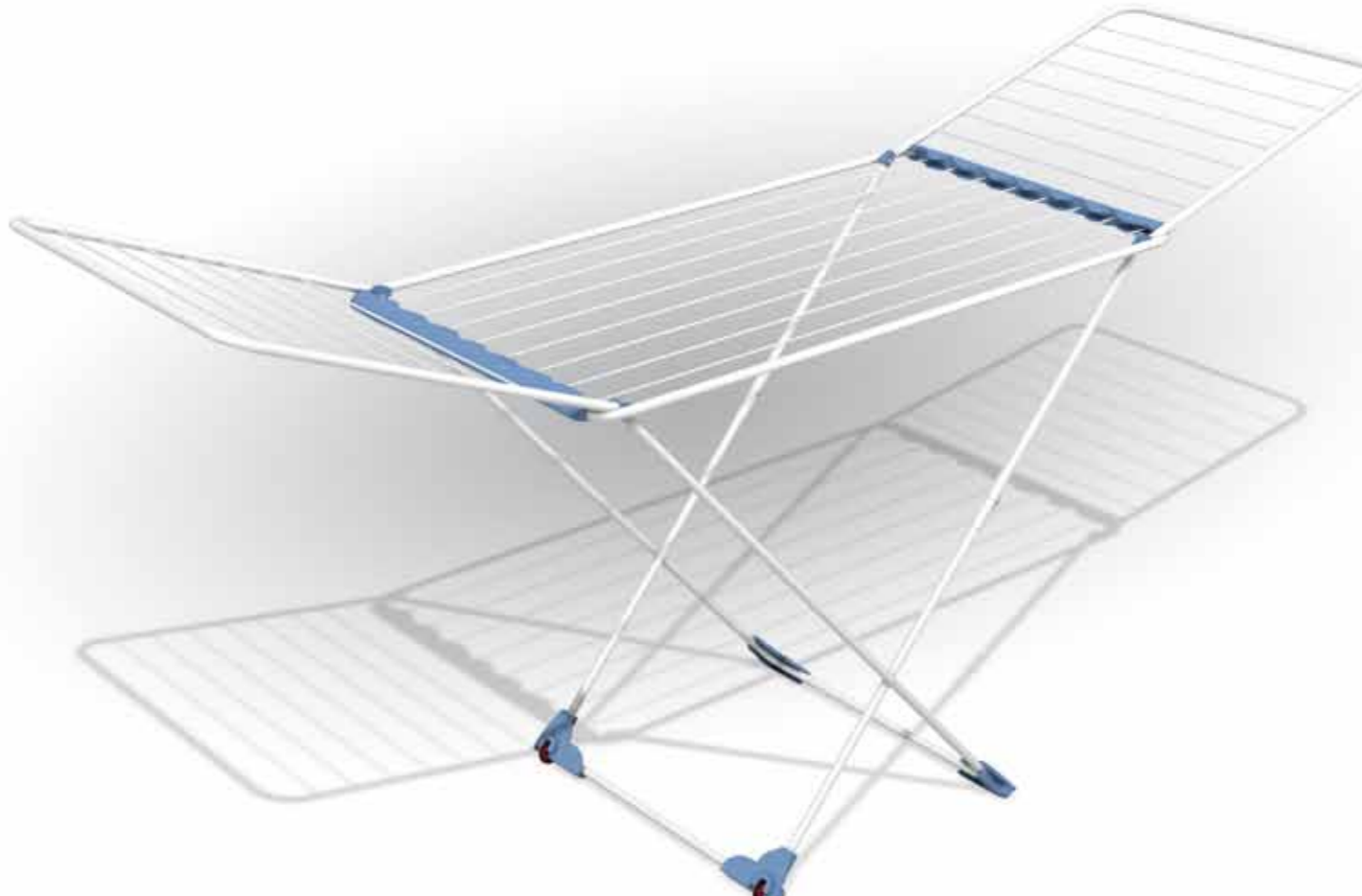

## Riche en accessoires!

**Pourquoi** Joints contre les égratignures en résine et roues pour le déplacer aisément. Couvertures latérales des fils pour une protection maximale contre la rouille

## ¡Con máximos accesorios!

**Porqué** Incluye guarniciones antiralladura de resina y ruedas para desplazarlo con comodidad. Cobertura de los extremos de los hilos para garantizar máxima protección contra el óxido

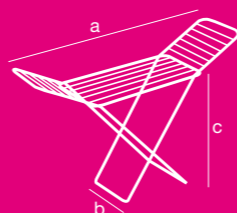

Item	Gimi	Ean	m	1 pz	kg	Aperto Open		Chiuso Folded		n° pz	n° pz	h=cm	n° pz
						axbxc=cm	axbxc=cm	axbxc=cm	axbxc=cm				
Top Super	10790080	8001244000568	20	3,10	17	201,5x55x93	55x5x130	60x20x136	6	48	151	36	

# Plus

## 20 metri di eleganza e comodità!

**Categoria** Acciaio zincato e verniciato con resine trasparenti per una doppia protezione dalla ruggine

**Dove** Per ogni tipo di ambiente, esterno e interno

**Quanto** 20 m

**Perché** Bello da vedere e semplice da usare, ruote con angolari protettivi e copritestata dei fili in plastica colorata

## 20 metres of elegance and practicality!

**Category** Zinclated steel, painted with transparent resins for double rust protection

**Where** For any kind of environment, indoors or out

**What size** 20 m

**Why** Pretty to see and simple to use, the wheels have protective corner pieces, and the lines have coloured plastic end covers



# Rainbow

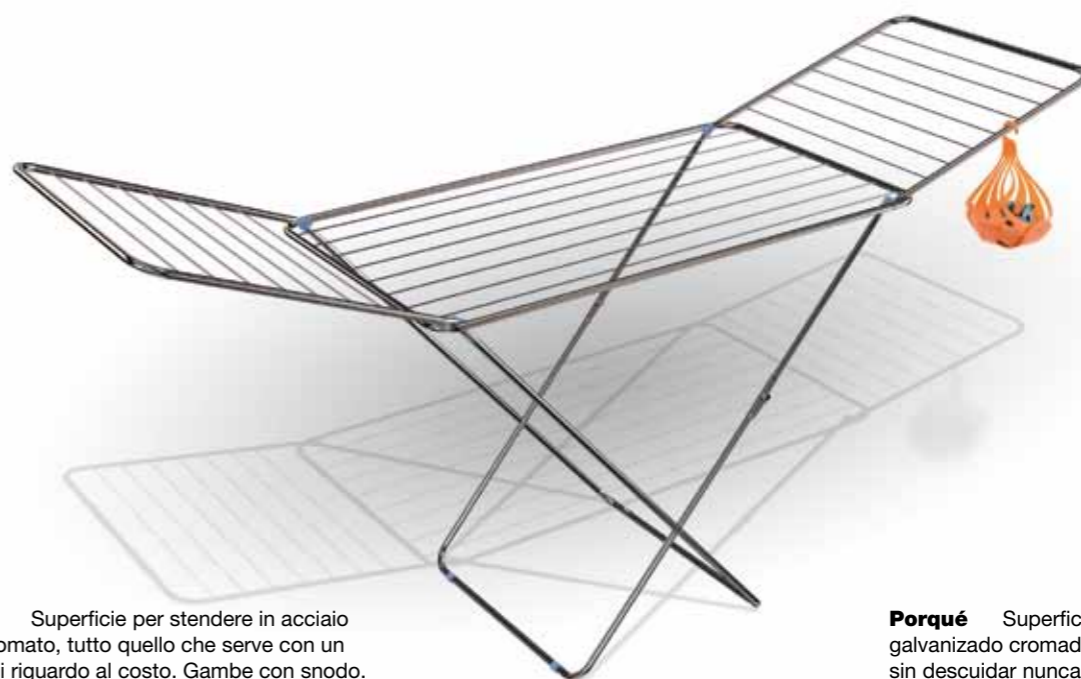

**Perché** Superficie per stendere in acciaio zinco-cromato, tutto quello che serve con un occhio di riguardo al costo. Gambe con snodo. Accessoriato con portamollette. (Mollette non incluse)

**Why** Hanging lines made of zincchromed steel, everything you need at the right price. Hinged legs. Comes with clothes peg holder. (Clothes pegs not included)

**Merkmal** Aufhängegitter aus Stahl, zinkverchromt, gutes Preis/Qualitäts-Verhältnis. Beingelenke. Zusätzlich ausgestattet mit Wäscheklammerbeutel. (Klammern nicht inklusiv)

**Porqué** Superficie para tender en acero galvanizado cromado, todo lo que se necesita sin descuidar nunca el coste. Jambes articulées. Incluye cesta para las pinzas. (Pinzas no incluidas)

**Pourquoi** Grilles d'étendage en acier galvanisé et chromé. Tout ce qui est nécessaire à un prix avantageux. Patas articuladas. Avec corbeille à pince à linge. (Pincettes non incluses)

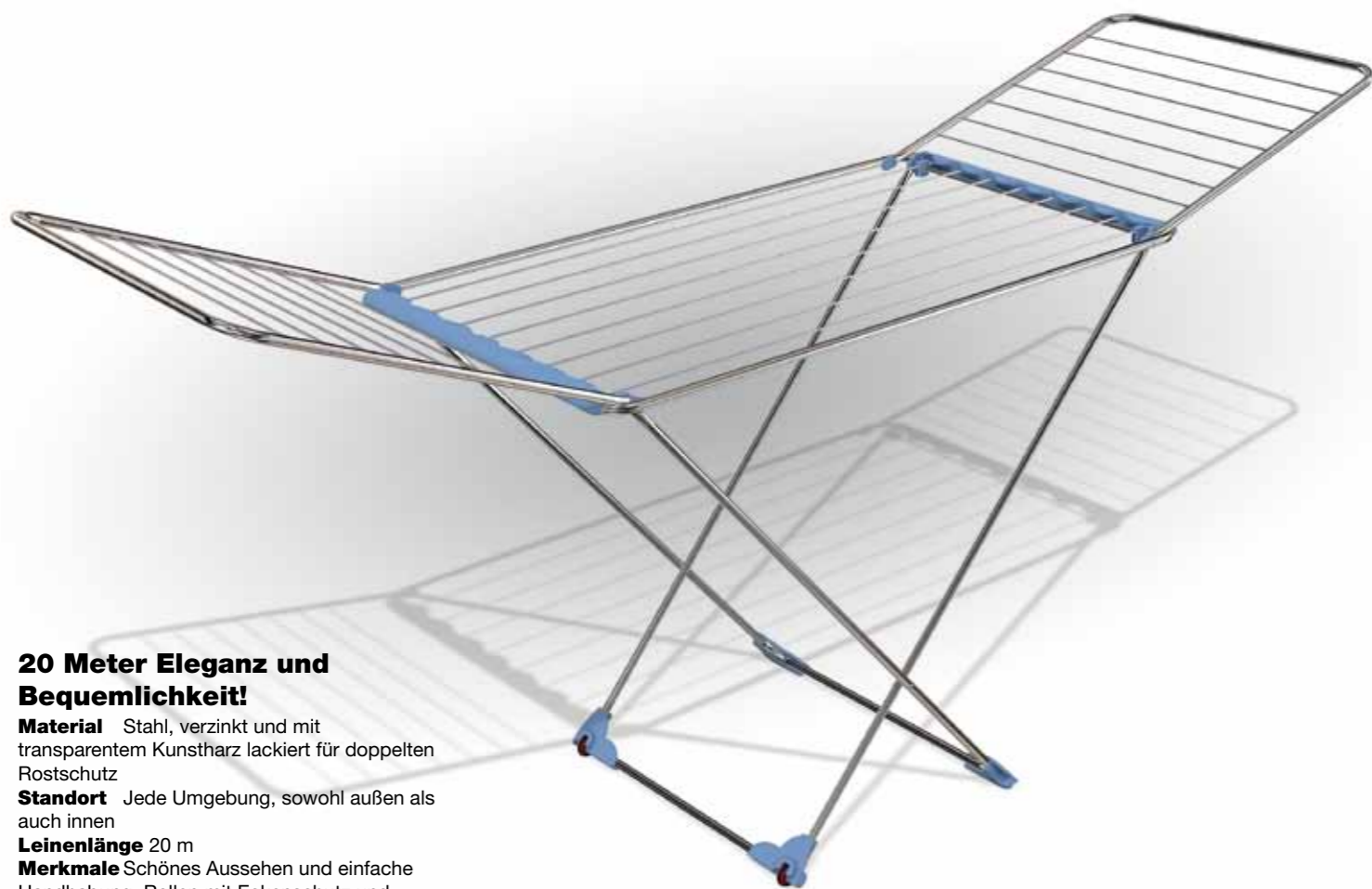

## 20 Meter Eleganz und Bequemlichkeit!

**Material** Stahl, verzinkt und mit transparentem Kunstharz lackiert für doppelten Rostschutz

**Standort** Jede Umgebung, sowohl außen als auch innen

**Leinenlänge** 20 m

**Merkmale** Schönes Aussehen und einfache Handhabung. Rollen mit Eckenschutz und Ummantelung der Drähte mit farbiger Plastikhülle

## 20 mètres d'élégance et de confort!

**Catégorie** Acier galvanisé et peint avec des résines transparentes pour une double protection contre la rouille

**Où** Pour n'importe quelle pièce. Aussi bien à l'intérieur qu'à l'extérieur

**Combien** 20 m

**Pourquoi** Beau et simple à utiliser. Roues avec cornières de protection et couvertures latérales des fils en plastique colorée

## ¡20 metros de elegancia y comodidad!

**Categoría** Acero galvanizado y pintado con resinas transparentes para garantizar una doble protección contra el óxido

**Dónde** Para todo tipo de ambiente, externo e interno

**Cuánto** 20 m

**Porqué** De hermoso aspecto y fácil de usar, ruedas con angulares protectores y coberturas de los extremos de los hilos en plástico coloreado

# Rainbow Color

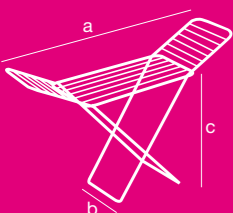
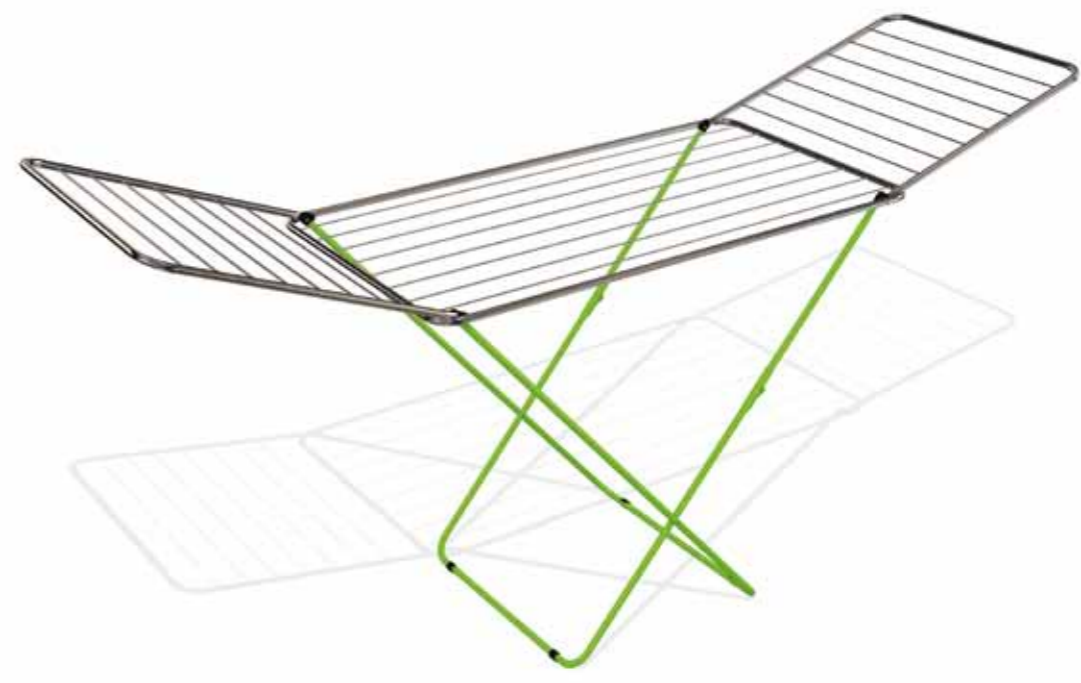

Item	Gimi	Ean	m	1 pz	kg	axbxc=cm	axbxc=cm	axbxc=cm	n° pz	n° pz	h=cm	n° pz
Plus	10620100	8001244106208	20	3,00	17	205x55x90,5	55x4x130	60x20x136	6	48	151	37

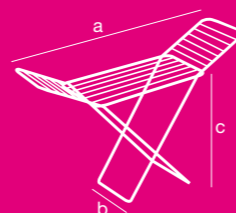

Item	Gimi	Ean	m	1 pz	kg	axbxc=cm	axbxc=cm	axbxc=cm	n° pz	n° pz	h=cm	n° pz
Rainbow	10710022	8001244008809	20	2,90	17	201,5x55x93	55x5x129	60x18,5x131	6	48	146	41
Rainbow Color	10710030	8001244011762	20	2,70	17	201,5x55x93	55x5x129	60x18,5x131	6	48	146	41

# Rocky

## Essenziale e... conveniente!

**Perché** In acciaio zincato, tutto quello che serve con un occhio di riguardo al costo

## Simple and... good value!

**Why** Made of zincplated steel, everything you need at the right price



# Aster

## Stendibiancheria Aster: il vantaggio deriva dai diversi materiali.

**Categoria** Griglia e prolunghe in acciaio inox, telaio di supporto in acciaio verniciato

## Clothes dryer Aster: the advantage lays in the different materials.

**Category** Rack and extensions made of stainless steel, frame made of painted steel

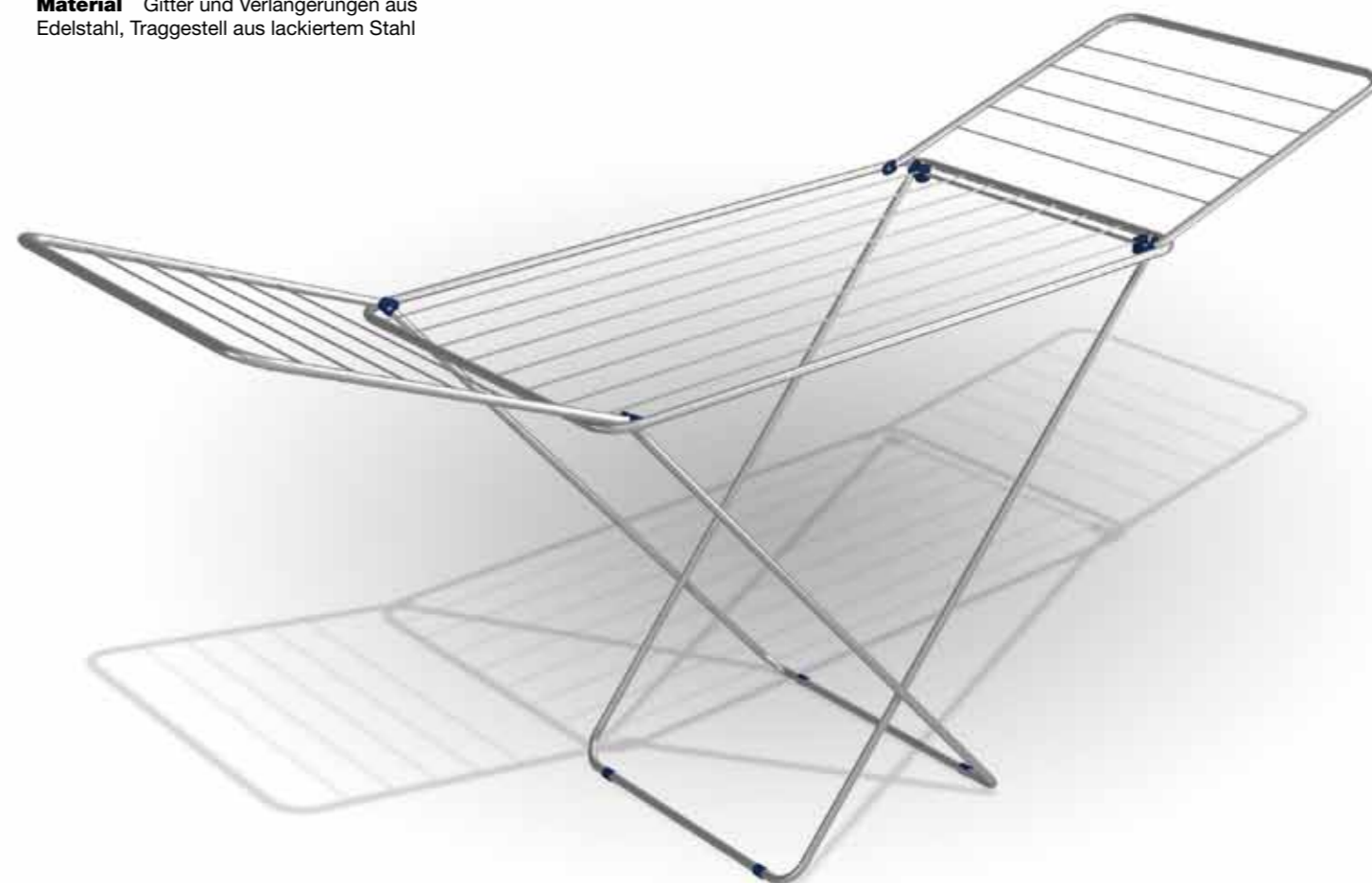

## ¡Eseñcial y... conveniente!

**Porqué** De acero galvanizado, todo lo que se necesita sin descuidar nunca el coste

## Schlicht und ... preiswert!

**Merkmale** Stahl, verzinkt, hohe Funktionalität, gute Kosten-/Nutzenbilanz

## Essentiel et... avantageux!

**Pourquoi** En acier galvanisé, tout ce qui est nécessaire à un prix avantageux

## Séchoir/étendoir Aster: le bénéfice réside dans les différents matériaux

**Catégorie** Grille et rallonges en acier inoxydable, structure de support en acier peint

## Tendedero Aster: la ventaja reside en los diversos materiales

**Categoría** rejilla y extensiones en acero inoxidable, estructura de soporte en acero pintado

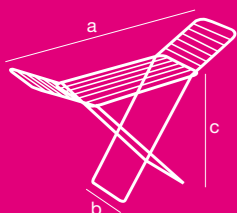

Item	Gimi	Ean	m	1 pz	kg	axbxc=cm	axbxc=cm	axbxc=cm	n° pz	n° pz	h=cm	n° pz
Rocky	10710000	8001244107632	20	2,60	17	205x55x90,5	55x4x128,5	60x18,5x131	6	48	146	41

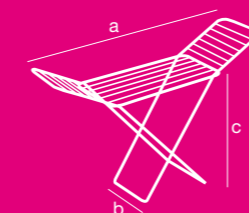

Item	Gimi	Ean	m	1 pz	kg	axbxc=cm	axbxc=cm	axbxc=cm	n° pz	n° pz	h=cm	n° pz
Aster	10030620	8001244001824	18	2,65	17	180x55x90,5	55x4x128,5	58x16x131	6	60	146	49

# Max Inox

## Fatto per durare!

**Category** Telaio realizzato in acciaio inox, superficie per stendere in Duralluminio®

**Dove** Per ogni tipo di ambiente, esterno e interno

**Quanto** 20 m

**Perché** La forza unica dell'acciaio inox, inattaccabile dalla ruggine, arricchito da angolari protettivi con ruote in gomma e abbellito dai copritestata dove appendere calzini e fazzoletti

## Made to last!

**Category** Frame made of stainless steel, drying surface made of Duralumin®

**Where** For any kind of environment, indoors or out

**What size** 20 m

**Why** The unique strength of stainless steel, rustproof, enriched with protective corner pieces with rubber wheels and end head covers to hang up socks and handkerchiefs

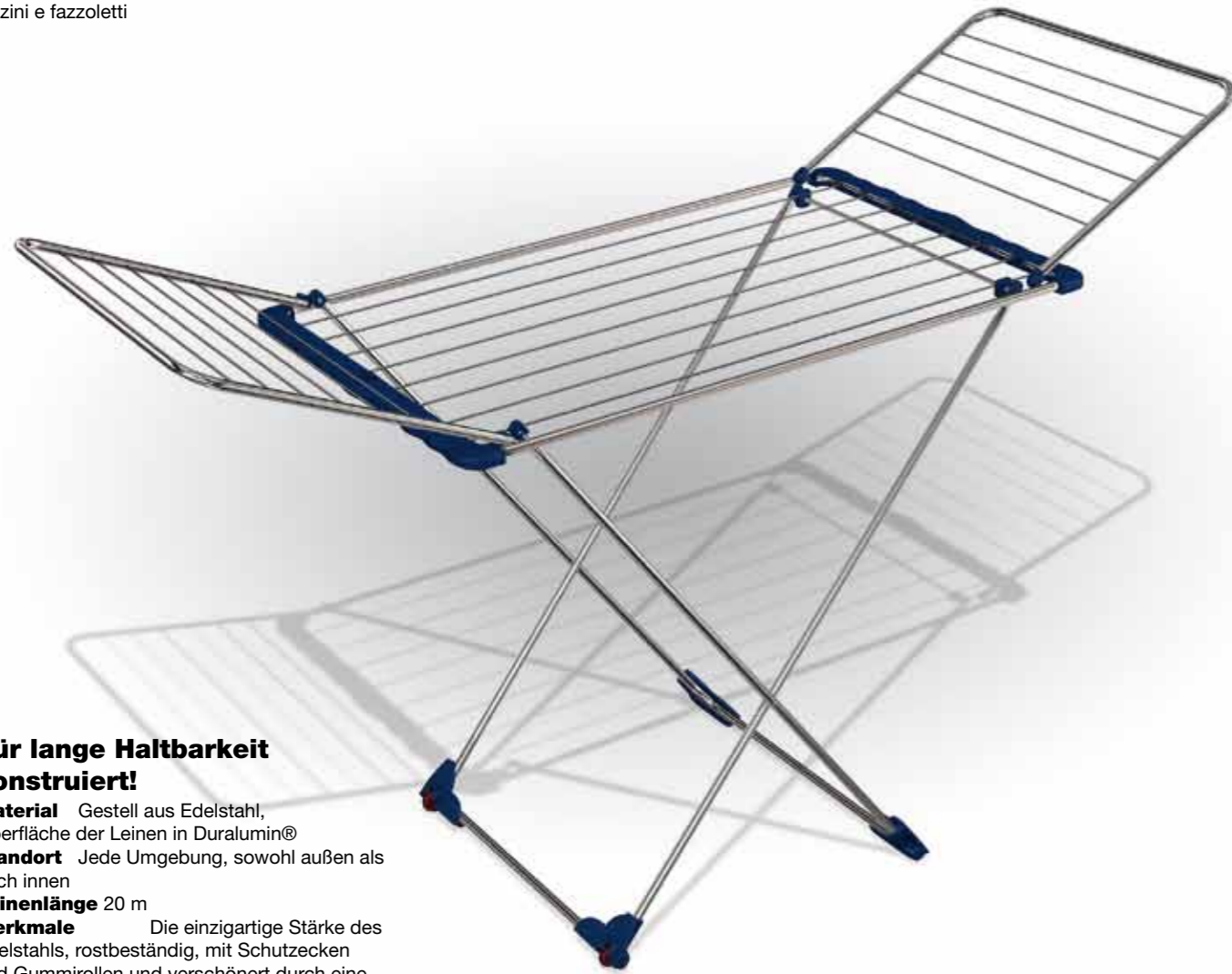

## Für lange Haltbarkeit konstruiert!

**Material** Gestell aus Edelstahl, Oberfläche der Leinen in Duralumin®

**Standort** Jede Umgebung, sowohl außen als auch innen

**Leinenlänge** 20 m

**Merkmale** Die einzigartige Stärke des Edelstahls, rostbeständig, mit Schutzecken und Gummirollen und verschönert durch eine praktische Abdeckung zum Aufhängen von Socken und Taschentüchern

## Durée garantie!

**Catégorie** Structure en acier inoxydable, surface pour étendre le linge en Duralumin®

**Où** Pour n'importe quelle pièce. Aussi bien à l'intérieur qu'à l'extérieur

**Combien** 20 m

**Pourquoi** La force unique de l'acier inoxydable, absolument résistant contre la rouille, et les cornières de protection pourvues de roues en caoutchouc et embellies par de couvertures latérales pour chaussettes et mouchoirs

## ¡Hecho para durar!

**Categoría** Bastidor realizado en acero inoxidable, superficie para tender en Duraluminio®

**Dónde** Para todo tipo de ambiente, externo e interno

**Cuánto** 20 m

**Porqué** La fuerza única del acero inoxidable, resiste eficazmente al óxido, enriquecido mediante angulares protectores con ruedas de goma y embellecido mediante cobertura para colgar calcetines y pañuelos

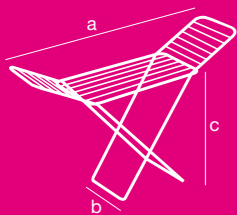

Item	Gimi	Ean	m	1 pz	kg	axbxc=cm	axbxc=cm	axbxc=cm	n° pz	n° pz	h=cm	n° pz
Max Inox	10490502	8001244107519	20	3,15	20	167x55,5x91	55,5x4x131	60x20x136	6	48	151	36

# Tender

**Category** Griglia e prolunghe in lega di alluminio, telaio di supporto in acciaio verniciato

**Perché** La qualità dell'alluminio, al massimo della convenienza

**Quanto** 20 m

**Material** Gitter und Verlängerung aus Aluminiumlegierung, Traggestell aus lackiertem Stahl

**Merkmale** Qualität des Aluminiums, maximale Wirtschaftlichkeit

**Leinenlänge** 20 m

**Category** Rack and extensions made of aluminium alloy, frame made of painted steel

**Why** The quality of aluminium, for the right price

**What size** 20 m

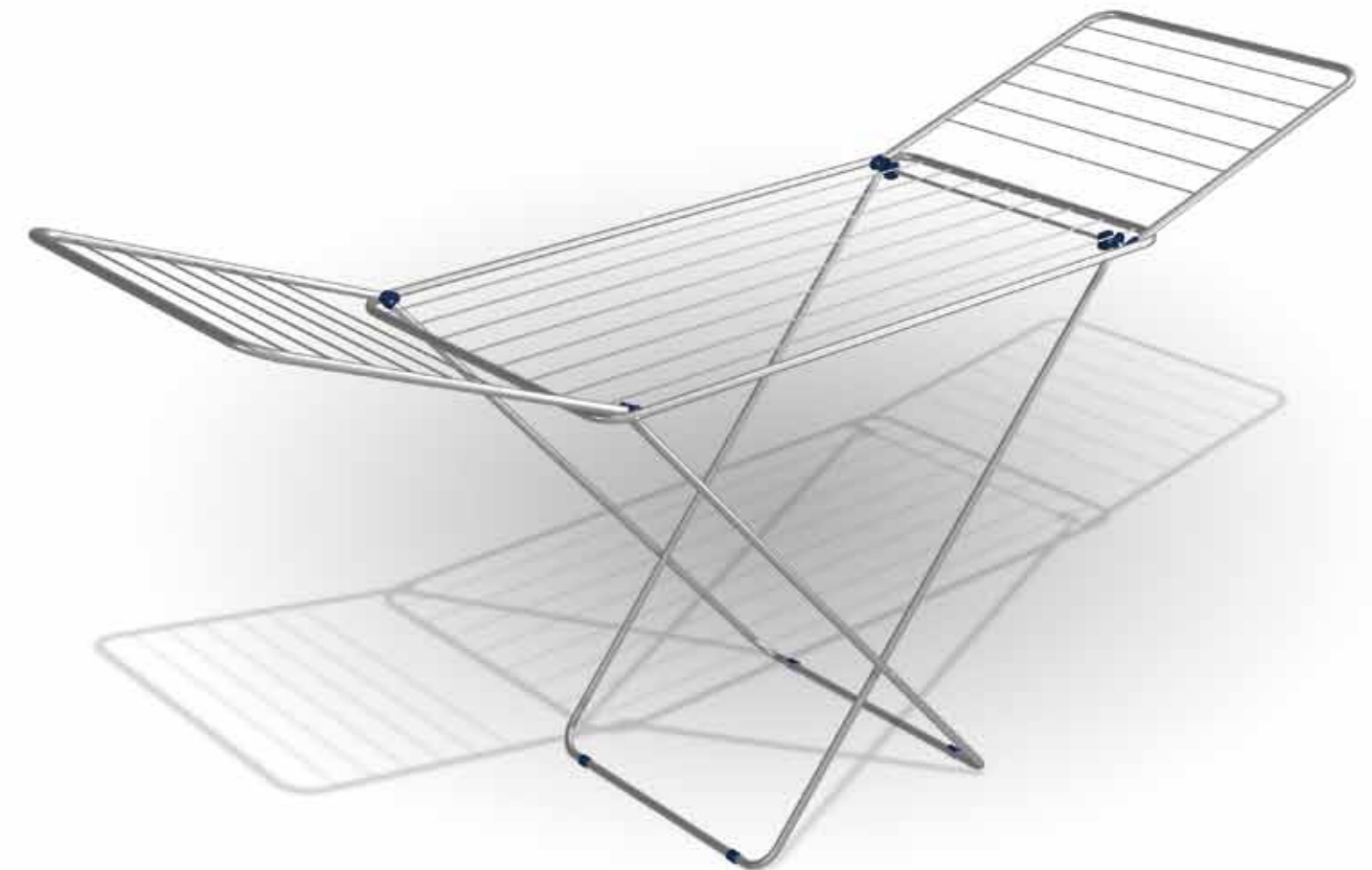

**Catégorie** Grille et rallonges en alliage d'aluminium, structure de support en acier peint

**Pourquoi** La qualité de l'aluminium à un prix avantageux

**Combien** 20 m

**Categoría** Rejilla y extensiones en aleación de aluminio, estructura de soporte en acero pintado

**Porqué** La calidad del aluminio con el máximo de la conveniencia

**Cuánto** 20 m

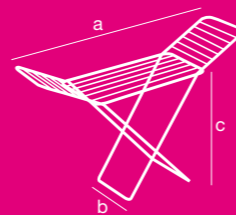

Item	Gimi	Ean	m	1 pz	kg	axbxc=cm	axbxc=cm	axbxc=cm	n° pz	n° pz	h=cm	n° pz
Tender	10775006	8001244833005	20	2,30	20	172,5x55,5x91	55,5x4,5x128,5	58x19,5x132	6	48	147	40



# Tender Color

## Prestazioni, convenienza e ora anche una nota di colore!

**Categoria** Griglia e prolunghe in lega di alluminio, telaio di supporto in acciaio verniciato  
**Quanto** 20 m

## Performance, convenienza and now a touch of colour too!

**Category** Rack and extensions made of aluminium alloy, frame made of painted steel  
**What size** 20 m

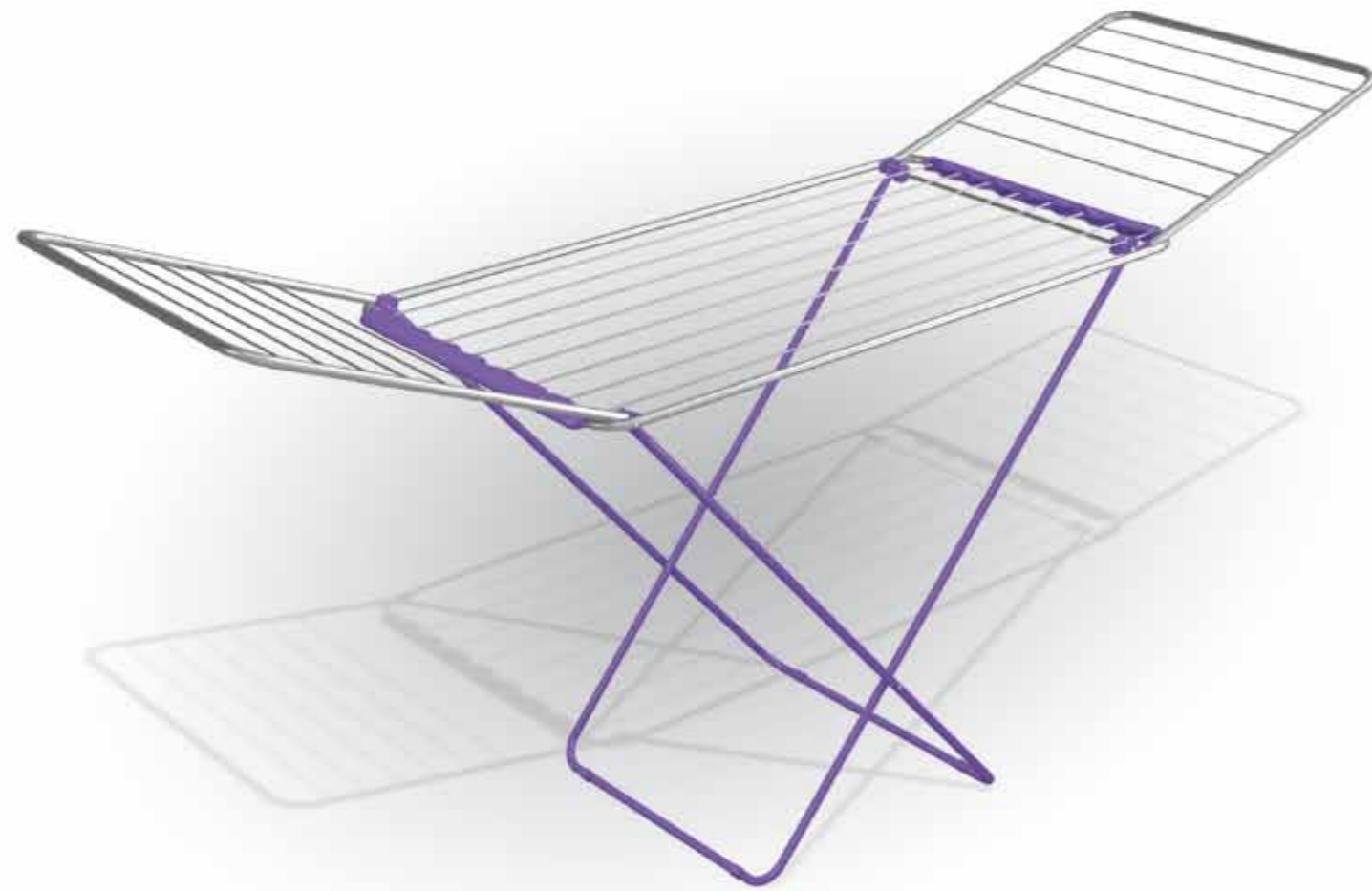

## Leistung und Preisniveau jetzt auch in neuen Farben!

**Material** Gitter und Verlängerung aus Aluminiumlegierung, Traggestell aus lackiertem Stahl  
**Leinenlänge** 20 m

## Performances, économie et maintenant aussi une touche de couleur!

**Catégorie** Grille et rallonges en alliage d'aluminium, structure de support en acier peint  
**Combien** 20 m

## ¡Prestaciones, conveniencia y ahora también un toque de color!

**Categoría** Rejilla y extensiones en aleación de aluminio, estructura de soporte en acero pintado  
**Cuánto** 20 m



# Mito

## Il top dell'innovazione: alluminio e apertura "Free Space"!

**Categoria** Griglia e prolunghe in lega di alluminio anodizzato, telaio di supporto in acciaio verniciato  
**Come** Con prolunghe laterali  
**Dove** Per ogni tipo di ambiente, esterno e interno  
**Quanto** 20 m  
**Perché** Eccezionale snodo "Free Space" per evitare che le gambe tocchino il bucato, angolari con ruote per facili spostamenti

## The best of innovation: aluminium and "Free Space" opening!

**Category** Rack and extensions made of anodised aluminium alloy, frame made of painted steel  
**How** With side extensions  
**Where** For any kind of environment, indoors or out  
**What size** 20 m  
**Why** Exceptional "Free Space" joint to prevent the legs touching the washing, corner pieces with wheels to easily move around



## Eine fantastische Innovation: Aluminium, mit Öffnungssystem "Free Space"!

**Material** Gitter und Verlängerung aus Eloxiertes Aluminiumlegierung, Traggestell aus lackiertem Stahl  
**Ausstattung** Mit seitlichen Erweiterungen  
**Standort** Jede Umgebung, sowohl außen als auch innen  
**Leinenlänge** 20 m  
**Merkmale** einzigartiges, Gelenksystem "Free Space", wodurch der Kontakt der Wäsche mit den Beinen verhindert wird. Dank der praktischen Rollen leicht verschiebbar

## L'atout de l'innovation: aluminium et ouverture "Free Space" !

**Catégorie** Grille et rallonges en alliage d'aluminium anodisé, structure de support en acier peint  
**Comment** Avec les rallonges latérales  
**Où** Pour n'importe quelle pièce. Aussi bien à l'intérieur qu'à l'extérieur  
**Combien** 20 m  
**Pourquoi** Articulation exceptionnelle "Free Space" pour éviter le contact entre les pieds et le linge; cornières pourvues de roues pour faciliter le déplacement

## ¡El máximo de la innovación: aluminio y apertura "Free Space"!

**Categoría** Rejilla y extensiones en aleación de aluminio galvanizado, estructura de soporte en acero pintado  
**Cómo** Con extensiones laterales  
**Dónde** Para todo tipo de ambiente, externo e interno  
**Cuánto** 20 m  
**Porqué** Excepcional articulación "Free Space" para evitar que las patas toquen la ropa lavada, angulares con ruedas para facilitar los desplazamientos

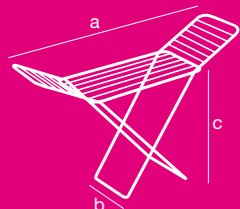
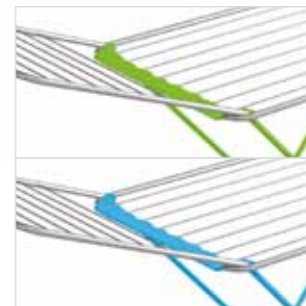

Item	Gimi	Ean	m	1 pz	kg	Aperto Open		Chiuso Folded		n° pz	n° pz	h=cm	n° pz
						axbxc=cm	axbxc=cm	axbxc=cm	axbxc=cm				
Tender Color	10775015	8001244011458	20	2,30	20	172,5x55,5x91	55,5x4,5x128,5	58x19,5x132	6	48	147	40	

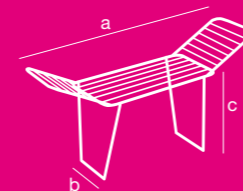

Item	Gimi	Ean	m	1 pz	kg	Aperto Open		Chiuso Folded		n° pz	n° pz	h=cm	n° pz
						axbxc=cm	axbxc=cm	axbxc=cm	axbxc=cm				
Mito	10505806	8001244050587	20	2,50	20	160x56,5x92	56,5x9,5x106	60x39,5x109	6	24	124	23	



# Tempo

**Categoria** Realizzato interamente in lega di alluminio

**Dove** Per ogni tipo di ambiente, esterno e interno

**Quanto** 20 m

**Perché** Un classico riproposto nel più innovativo dei materiali, inattaccabile dalla ruggine, semplice da spostare grazie agli angolari con ruote e abbellito dai copristata dove appendere calzini e fazzoletti

**Category** Made entirely of aluminium alloy

**Where** For any kind of environment, indoors or out

**What size** 20 m

**Why** A classic made in the most innovative of materials, rustproof, simple to move thanks to the corner pieces with wheels, and enriched with line end covers to hang up socks and handkerchiefs

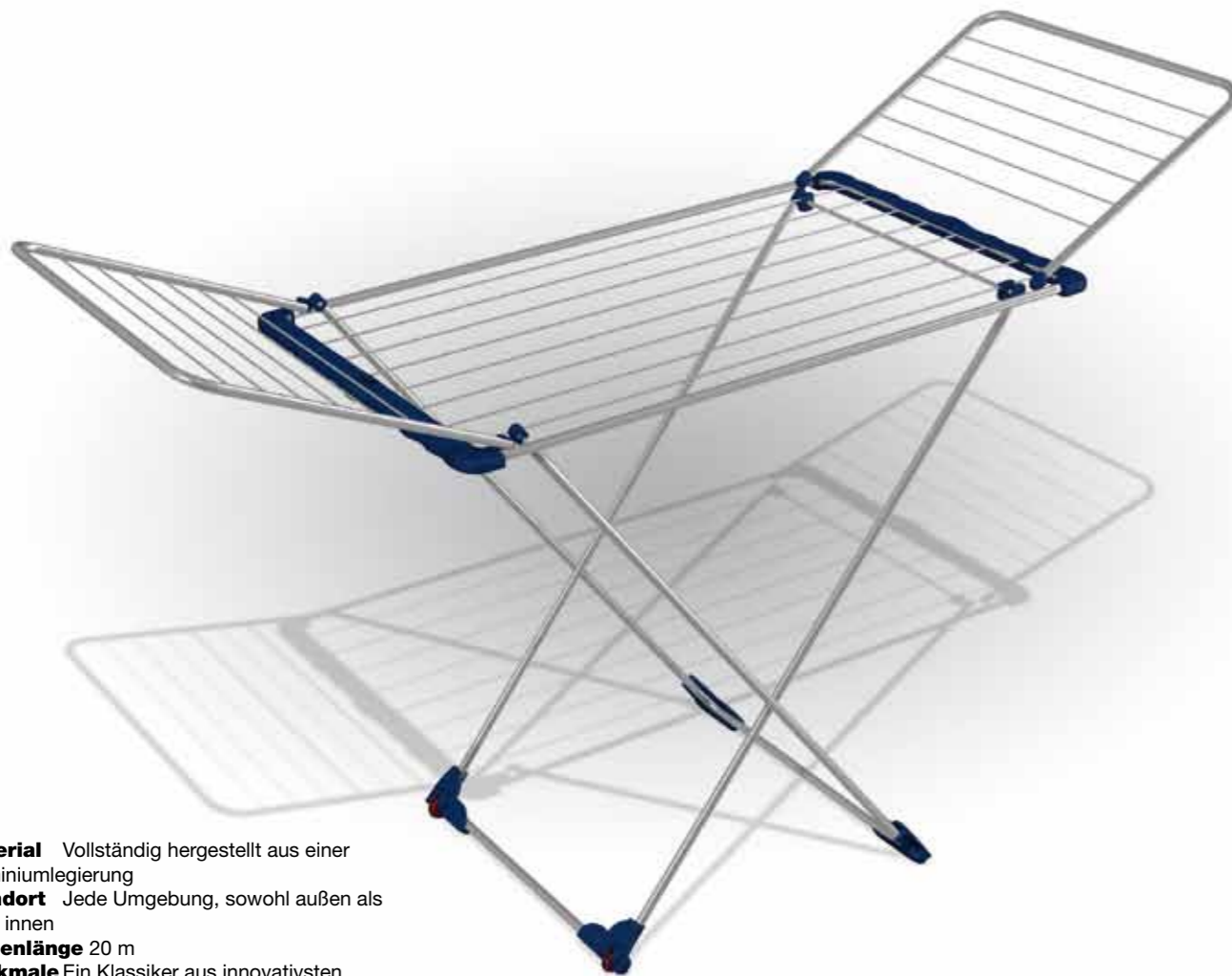

**Material** Vollständig hergestellt aus einer Aluminiumlegierung

**Standort** Jede Umgebung, sowohl außen als auch innen

**Leinenlänge** 20 m

**Merkmale** Ein Klassiker aus innovativsten Materialien, rostbeständig, dank der Rollen leicht verschiebbar und durch Abdeckungen verschönt zum Aufhängen von Socken und Taschentüchern

**Catégorie** Fabriqué entièrement en alliage d'aluminium

**Où** Pour n'importe quelle pièce. Aussi bien à l'intérieur qu'à l'extérieur

**Combien** 20 m

**Pourquoi** Un produit classique proposé à nouveau avec le matériau le plus innovant, résistant à la rouille, simple à déplacer grâce aux cornières pourvues de roues. Plus de beauté avec les couvertures latérales pour chaussettes et mouchoirs

**Categoría** Realizado enteramente en aleación de aluminio

**Dónde** Para todo tipo de ambiente, externo e interno

**Cuánto** 20 m

**Porqué** Un producto clásico propuesto esta vez en el más innovador de los materiales, resiste eficazmente al óxido, fácil de desplazar gracias a los angulares con ruedas y embellecido mediante cobertura cobertura para colgar calcetines y pañuelos



# Tempo Color

**La praticità dell'alluminio abbinata a colori freschi e trendy!**

**Practical aluminium combined with bright trendy colours!**

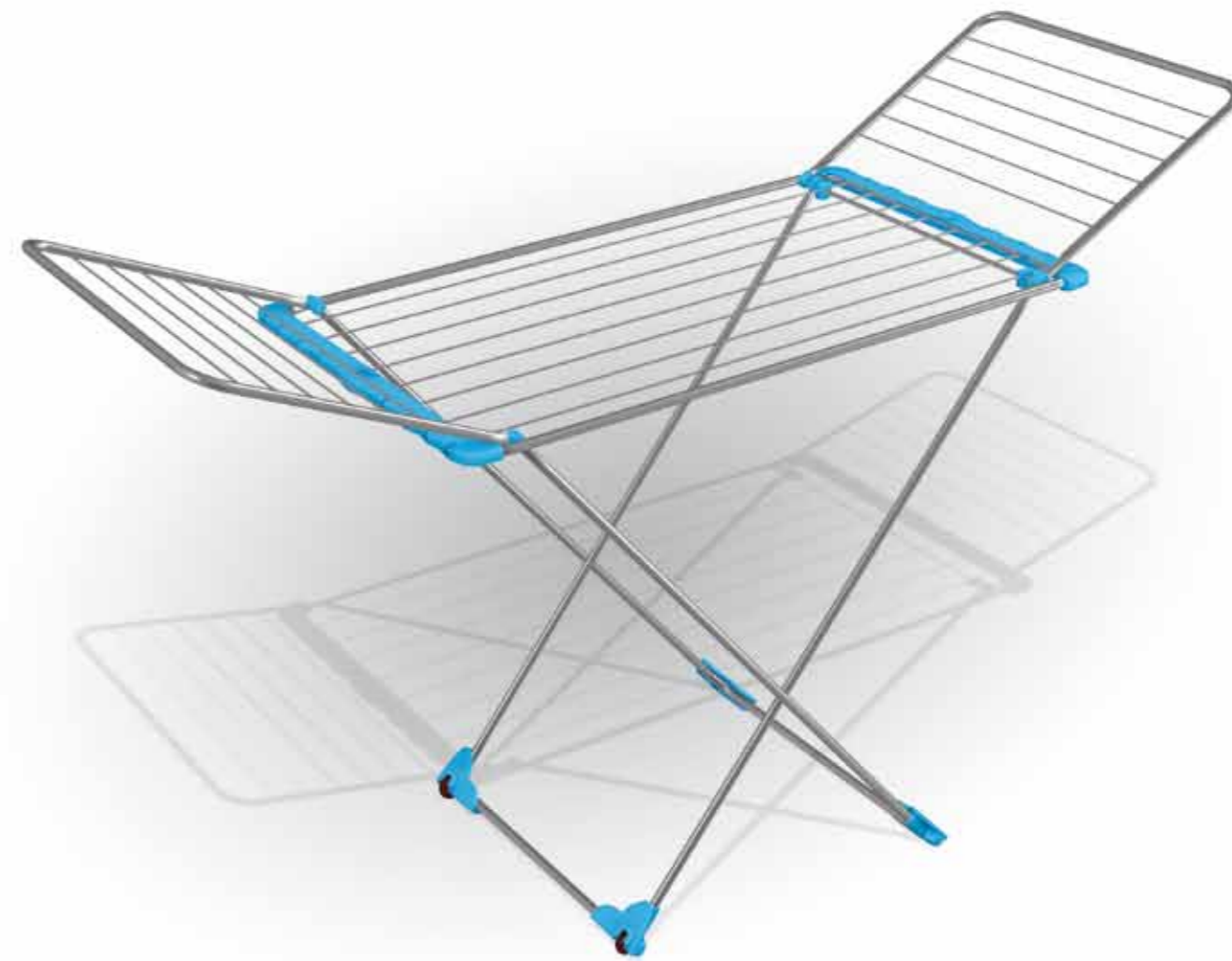

**Das praktische Aluminium ist mit Farben verkleidet, die frisch und trendy wirken!**

**L'avantage pratique de l'aluminium s'accompagne à des couleurs fraîches et tendance!**

**¡La funcionalidad del aluminio combinada con colores frescos y trendy!**

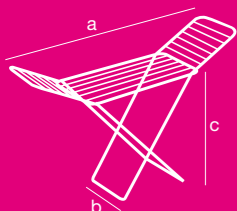
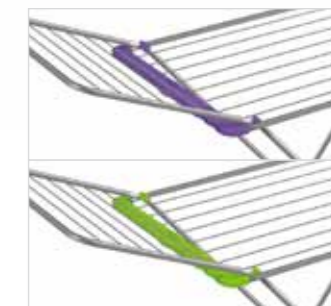

Item	Gimi	Ean	m	1 pz	kg	axbxc=cm	axbxc=cm	axbxc=cm	n° pz	n° pz	h=cm	n° pz
Tempo	10770002	8001244108554	20	2,30	20	167x55,5x91,5	55,5x4x131,5	58x19,5x132	6	48	147	40

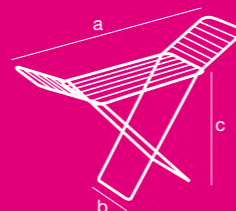

Item	Gimi	Ean	m	1 pz	kg	axbxc=cm	axbxc=cm	axbxc=cm	n° pz	n° pz	h=cm	n° pz
Tempo Color	10770015	8001244011472	20	2,30	20	167x55,5x91,5	55,5x4x131,5	58x19,5x132	6	48	147	40

# Tempo Super



## La tradizione in veste hi-tech estensibile!

**Categoria** Realizzato interamente in lega di alluminio

**Dove** Per ogni tipo di ambiente, esterno e interno

**Quanto** 25 m

**Perché** Calzini, fazzoletti, biancheria non occupano più lo spazio di altri capi perché si collocano anche sulle 4 miniprolunghe estraibili

## Traditional style combined with extensible high technology!

**Category** Made entirely of aluminium alloy

**Where** For any kind of environment, indoors or out

**What size** 25 m

**Why** Socks, handkerchiefs and underwear no longer take the room of other clothes because they can be hung up on the 4 telescopic mini-extensions

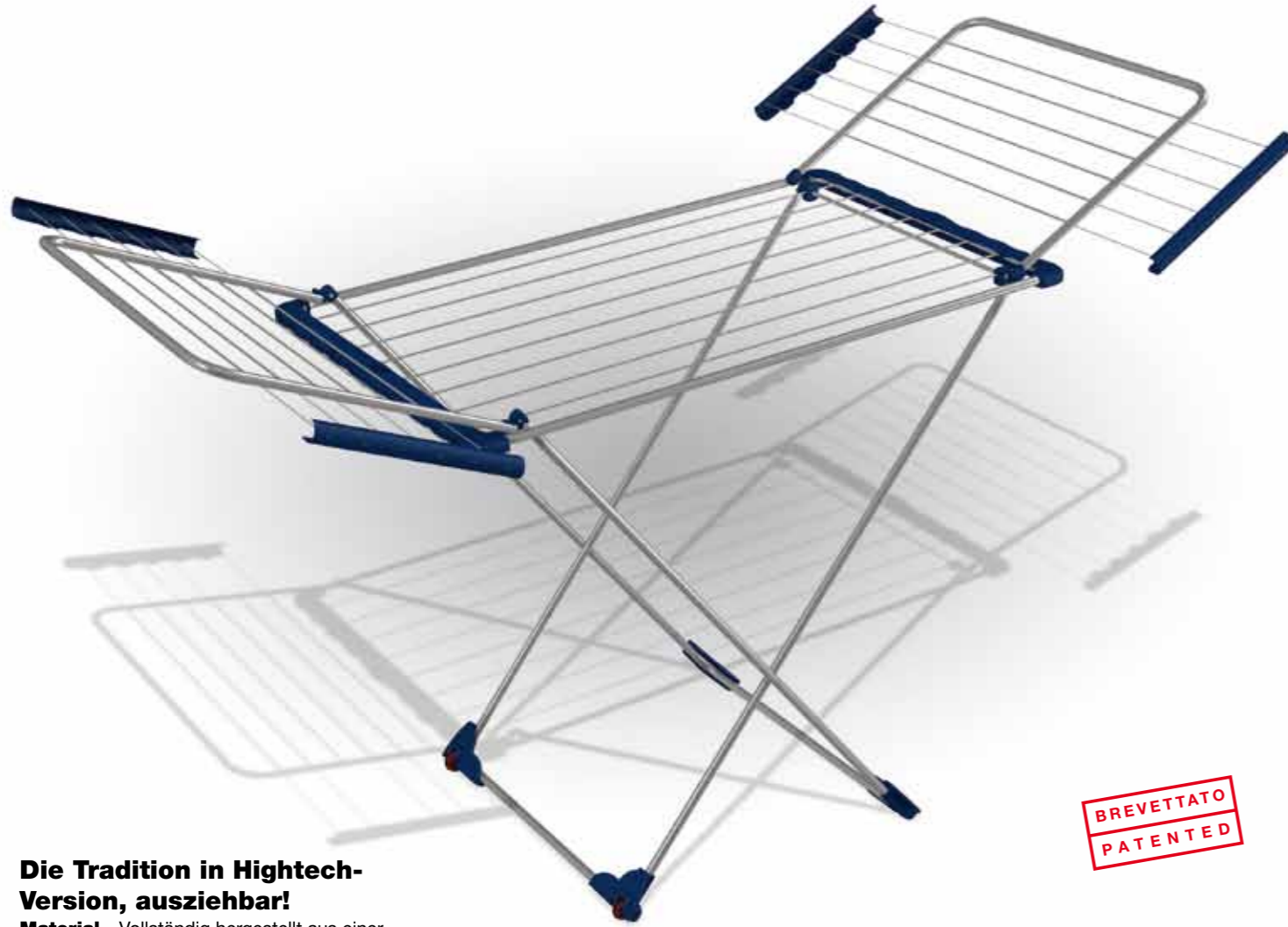

BREVETTATO  
PATENTED

## Die Tradition in Hightech-Version, ausziehbar!

**Material** Vollständig hergestellt aus einer Aluminiumlegierung

**Standort** Jede Umgebung, sowohl außen als auch innen

**Leinenlänge** 25 m

**Merkmale** Ein Socken, Taschentücher und Wäsche können nun auch auf platz sparende Weise auf den 4 ausziehbaren Verlängerungen aufgehängt werden

## La tradition revêue d'hi-tech extensible!

**Catégorie** Fabriqué entièrement en alliage d'aluminium

**Où** Pour n'importe quelle pièce. Aussi bien à l'intérieur qu'à l'extérieur

**Combien** 25 m

**Pourquoi** Les chaussettes, les mouchoirs et la lingerie laissent l'espace aux autres vêtements parce qu'ils peuvent être suspendus aux 4 mini-rallonges escamotables

## ¡La tradición en versión high-tech extensible!

**Categoría** Realizado enteramente en aleación de aluminio

**Dónde** Para todo tipo de ambiente, externo e interno

**Cuánto** 25 m

**Porqué** Calcetines, pañuelos, lencería... dejan espacio libre para las demás prendas pues se cuelgan también en las 4 mini extensiones extraíbles

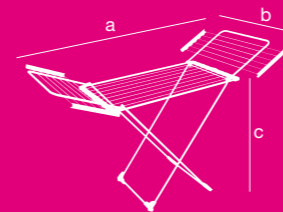

Aperto  
Open

Chiuso  
Folded



Item	Gimi	Ean	m	1 pz	kg	axbxc=cm	axbxc=cm	axbxc=cm	n° pz	n° pz	h=cm	n° pz
Tempo Super	10770025	8001244007697	25	2,90	20	170x97x92	56x6x132	60x21x133	6	48	148	35

# Cucciolo

## Il piccolo degli stendibiancheria a cavalletto

**Categoria** 100% resina  
**Dove** Per esterni e interni, l'unico che si infila anche nella vasca da bagno  
**Quanto** 10 m  
**Perché** Quando lo spazio è poco. Ideale anche in campeggio

## The smallest X legs clothes-dryer

**Category** 100% resin  
**Where** Outdoors and indoors, the only one that can fit your bath  
**What size** 10 m  
**Why** It fits the smallest spaces; ideal for camping applications



## Der Kleinste der Wäscheständer mit gekreuzten Beinen

**Material** 100% Harz  
**Standort** Für innen und außen, der einzige Ständer, der auch in der Badewanne Platz hat  
**Leinenlänge** 10 m  
**Merkmale** Optimal bei Platzmangel, ideal auch auf dem Campingplatz

## Le plus petit des séchoirs à poser

**Matière** 100% résine  
**Où** Aussi bien à l'intérieur qu'à l'extérieur, le seul pour baignoires  
**Combien** 10 m  
**Pourquoi** Idéal pour les espaces les plus petits et pour le camping

## El más pequeño de los tendederos portátiles a caballito

**Categoría** 100% resina  
**Dónde** Para exterior/interior, es el único que se puede colocar también en la bañera  
**Cuánto** 10 m  
**Porqué** Cuando hay problemas de espacio. Ideal también para ir de camping



# Zaffiro

## Resistenza e cura dei particolari!

**Categoria** 100% resina  
**Dove** Per ogni tipo di ambiente, esterno e interno  
**Quanto** 20 m  
**Perché** Arreda ogni ambiente; dotato di ruote per essere spostato anche con il bucato steso, pratico da chiudere grazie allo snodo inventato da Gimi, è realizzato in materiale totalmente riciclabile

## Resistance and attention to detail!

**Category** 100% resin  
**Where** For any kind of environment, indoors or out  
**What size** 20 m  
**Why** To decorate any environment; fitted with wheels, so it can be moved even with the washing on it. Practical to close thanks to the joint designed by Gimi. Made of 100% recyclable material

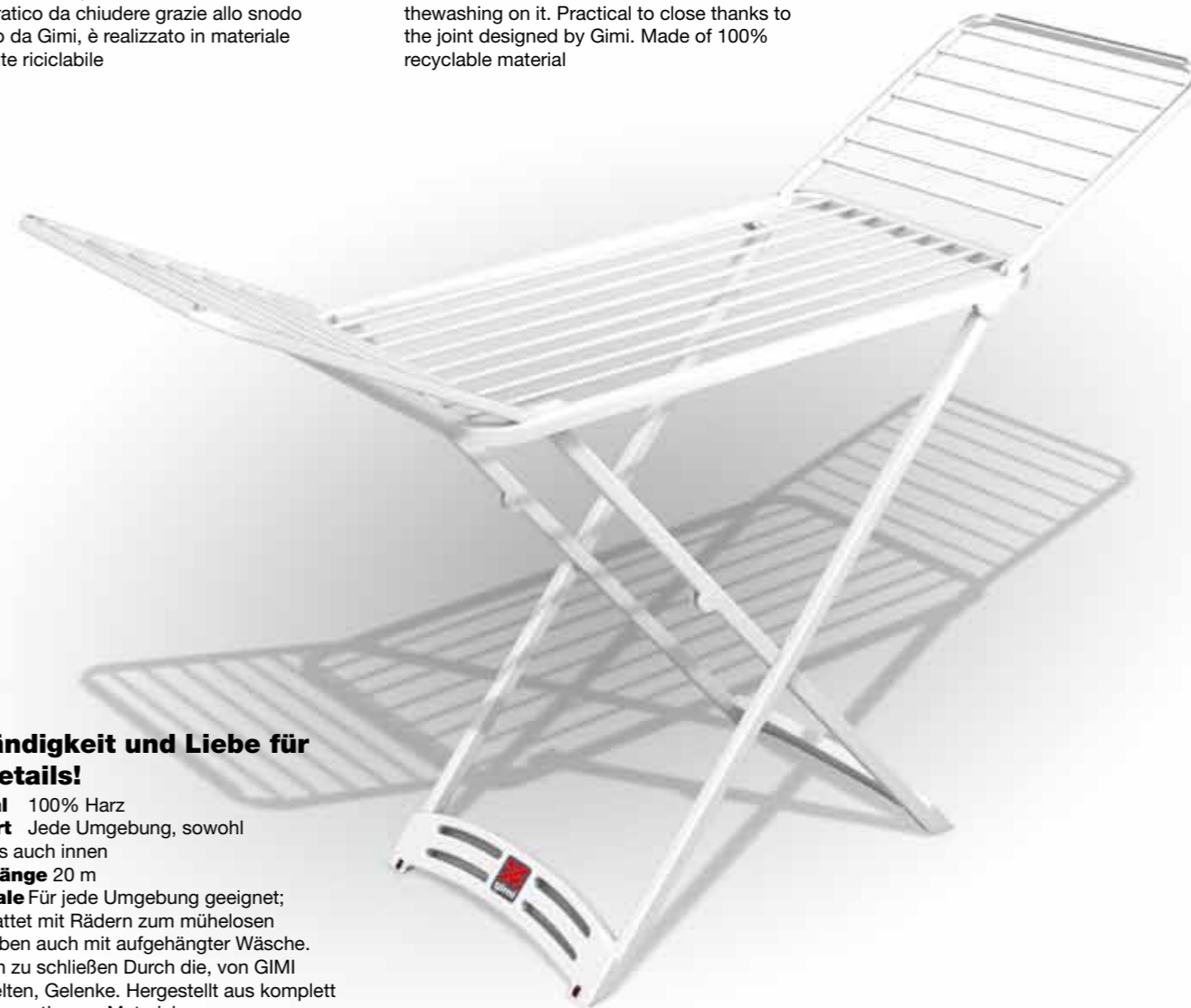

## Beständigkeit und Liebe für die Details!

**Material** 100% Harz  
**Standort** Jede Umgebung, sowohl außen als auch innen  
**Leinenlänge** 20 m  
**Merkmale** Für jede Umgebung geeignet; ausgestattet mit Rädern zum mühelosen Verschieben auch mit aufgehängter Wäsche. Praktisch zu schließen Durch die, von GIMI entwickelten, Gelenke. Hergestellt aus komplett wiederverwertbarem Material

## La résine plastique: le matériau du futur!

**Matière** 100% résine  
**Où** Pour n'importe quelle pièce. Aussi bien à l'intérieur qu'à l'extérieur  
**Combien** 20 m  
**Pourquoi** Pour meubler et décorer n'importe quelle pièce. Il est pourvu de roues permettant de le déplacer même lorsque le linge est étendu. Pratique à fermer grâce à l'articulation inventée par Gimi, il est fabriqué avec un matériau complètement recyclable

## ¡Gran atención en la producción de sus componentes de alta resistencia!

**Categoría** 100% resina  
**Dónde** Para todo tipo de ambiente, externo e interno  
**Cuánto** 20 m  
**Porqué** Decora todo tipo de ambiente; con ruedas para poder desplazarlo incluso con la ropa tendida, práctico de cerrar gracias a la bisagra inventada por Gimi y realizado en material enteramente reciclable

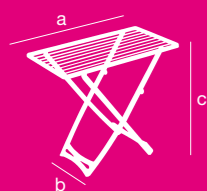

Item	Gimi	Ean	m	1 pz	kg	axbxc=cm	axbxc=cm	axbxc=cm	n° pz	n° pz	h=cm	n° pz
Cucciolo	10124900	8001244007543	10	1,65	8	92x50x81	50x6,5x114	51x13,5x116	2	24	131	25

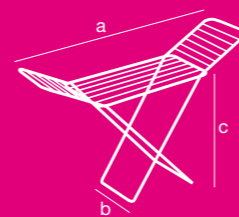

Item	Gimi	Ean	m	1 pz	kg	axbxc=cm	axbxc=cm	axbxc=cm	n° pz	n° pz	h=cm	n° pz
Zaffiro	10970210	8001244003422	20	4,85	20	181,5x55x88	55x9,5x127	120x133x221	50	50	221	14
								55x18x126	2	16	141	16

# Perla

## Design elegante e materiale ad elevate prestazioni!

**Categoria** 100% resina  
**Dove** Per ogni tipo di ambiente, esterno e interno  
**Quanto** 20 m  
**Perché** Pratico da chiudere (grazie allo snodo inventato da Gimi) e da muovere (grazie alle ruote incorporate), è bello da vedere e indistruttibile grazie all'innovativa tecnologia di co-iniezione di azoto

## Elegant design, high-performance material!

**Category** 100% resin  
**Where** For any kind of environment, indoors or out  
**What size** 20 m  
**Why** Practical to close (thanks to the joint designed by GIMI) and to move around (thanks to built-in wheels), it is pleasing to the eye, and virtually indestructible thanks to the innovative nitrogen co-injection technology

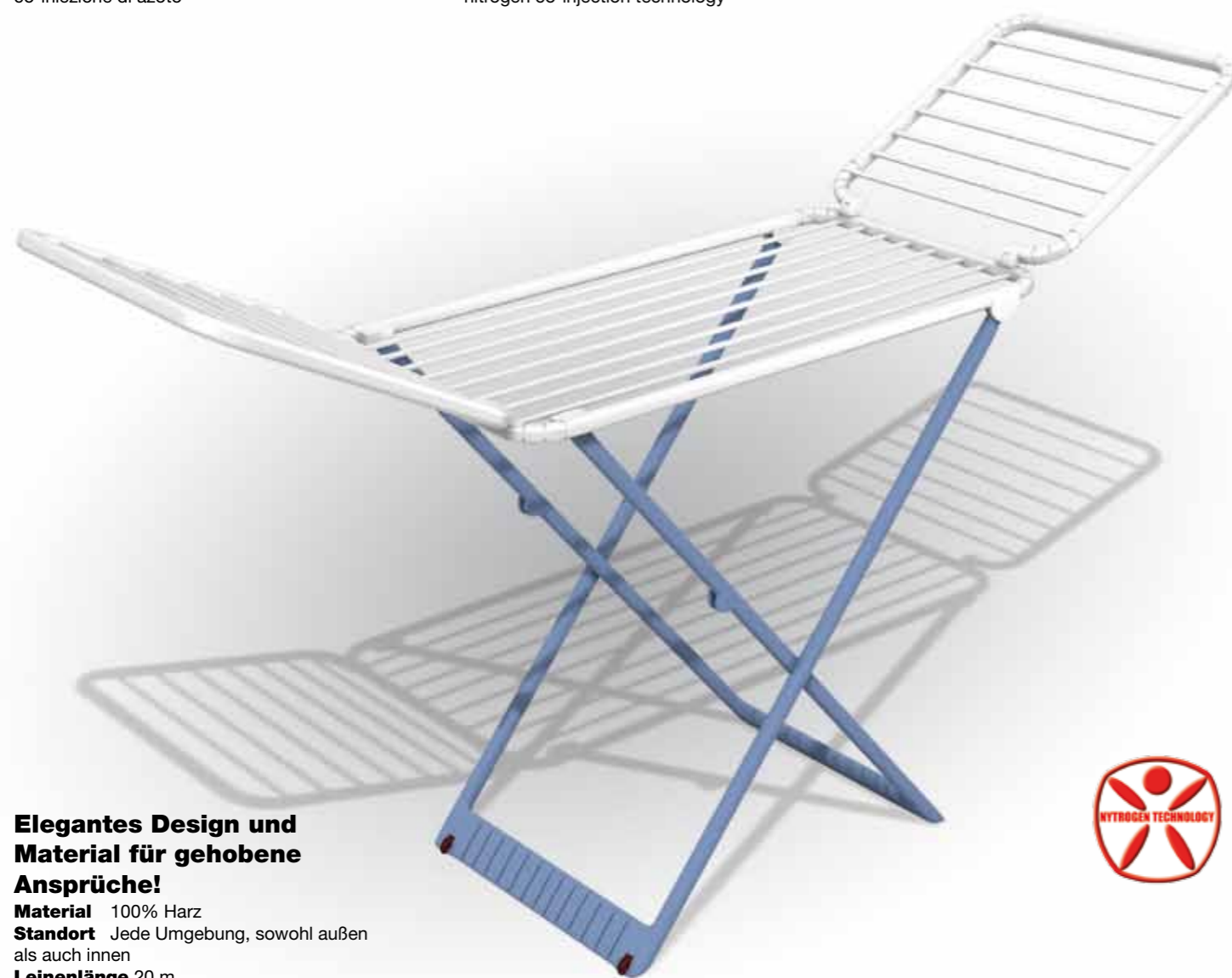

## Elegantes Design und Material für gehobene Ansprüche!

**Material** 100% Harz  
**Standort** Jede Umgebung, sowohl außen als auch innen  
**Leinenlänge** 20 m  
**Merkmale** Praktisch zusammenklappbar (Durch die, von GIMI entwickelten, Gelenke) ebenso leicht zu bewegen (durch die angebrachten Rollen); Perla ist schön anzusehen und außerdem - dank der innovativen Technologie der Koinjektion von Stickstoff - unverwüstlich

## Un design élégant et un matériau très performant!

**Matière** 100% résine  
**Où** Pour n'importe quelle pièce. Aussi bien à l'intérieur qu'à l'extérieur  
**Combien** 20 m  
**Pourquoi** Pratique à fermer (grâce à l'articulation inventée par Gimi) et à déplacer (grâce aux roues), il est beau et indestructible grâce à la technologie à l'avant-garde qui utilise l'injection d'azote

## ¡Un diseño elegante y componentes de alta calidad!

**Categoría** 100% resina  
**Dónde** Para todo tipo de ambiente, externo e interno  
**Cuánto** 20 m  
**Porqué** Porqué es práctico de cerrar (gracias a la bisagra inventada por Gimi) y bonito de verlo, indestructible gracias a la innovadora tecnología de inyección con nitrógeno

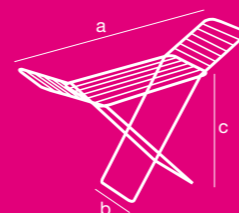

Item	Gimi	Ean	m	1 pz	kg	axbxc-cm	axbxc-cm	axbxc-cm	n° pz	n° pz	h-cm	n° pz
Perla	10610500	8001244061606	20	5,4	20	190x54,5x90	54,5x10x133	55x19x130	2	16	145	14

# Stendi biancheria estensibili e multifunzione

# Alablock Extend



**Categoria** Acciaio verniciato  
**Dove** Per vasche da bagno  
**Quanto** 16 m  
**Perché** Per stendere di più grazie alla pratica griglia telescopica

**Category** Painted steel  
**Where** For baths  
**What size** 16 m  
**Why** To dry more thanks to the practical telescopic rack

**Material** Stahl, lackiert  
**Standort** Badewannen  
**Leinenlänge** 16 m  
**Merkmale** Dank des praktischen Teleskopgitters lässt sich mehr Wäsche aufhängen

Categoria Category		Nome prodotto Item	Plus			
			Esclusiva Gimi Gimi exclusive	Accessori* Accessories*	Snodi sicurezza Safety joint	Altro Other
Estensibili Extensible	m 16	Alablock Extend			✓	
	m 20	Brezza Extend	✓			
		Stendissimo	✓	✓	✓	
		Albatross	✓	✓	✓	
		Extension	✓	✓	✓	supporto fili pieghevole folding lines-support
		Dinamik 20	✓	✓		apertura free-space free-space opening
	m 28	Dinamik 30	✓	✓		apertura free-space free-space opening
Dinamik 30 color		✓	✓		apertura free-space free-space opening stendi scarpe shoes hangers	
Multifunzione Multi-functional	m 18	Duplo	✓	✓		apertura free-space free-space opening

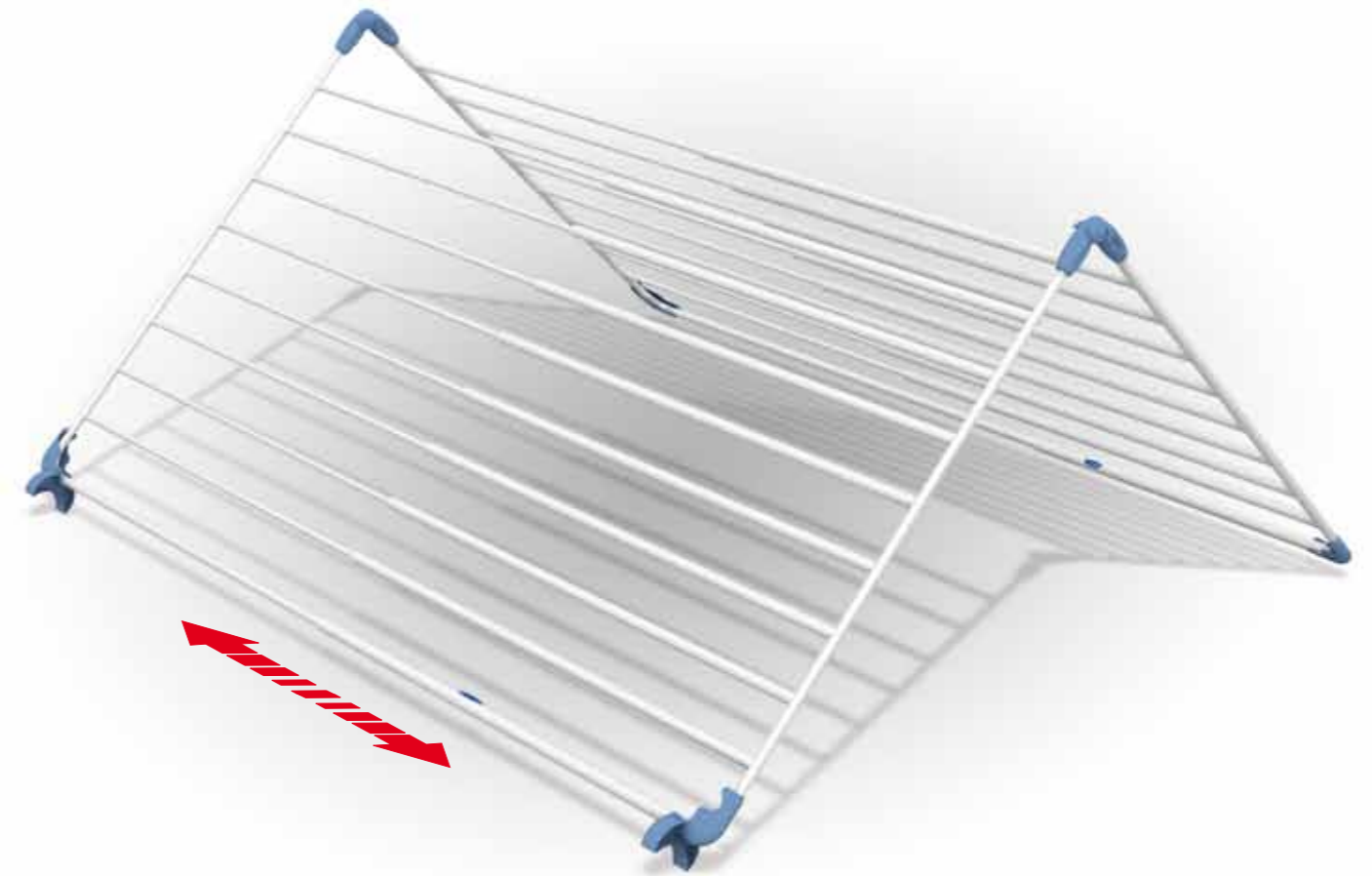

**Catégorie** Acier peint  
**Où** Pour les baignoires  
**Combien** 16 m  
**Pourquoi** Pour étendre plus de linge grâce à sa pratique grille télescopique

**Categoría** Acero pintado  
**Dónde** Para bañeras  
**Cuánto** 16 m  
**Porqué** Para colgar más ropa gracias a su práctica parrilla telescópica



\*Per esempio: ruote gommata, stendi fazzoletti  
 For instance: rubber wheels, handkerchiefs hangers

\*\*Per esempio: verniciatura epossidica, elettrozincatura  
 For instance: extra powder coating, galvanization

= Nitrogen Technology

Per descrizioni dettagliate consultare le pagine dei singoli prodotti.  
 For more details please see the related product pages.

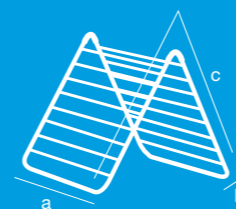

Item	Gimi	Ean	m	1 pz	kg	axbxc=cm	axbxc=cm	axbxc=cm	n° pz	n° pz	h=cm	n° pz
Alablock Extend	10020111	8001244006133	16	2,95	10	104x8x141	67x5,5x71	69x24,5x73	5	50	161	40



Aperto  
Open

Chiuso  
Folded



# Brezza Extend

## L'unico stendibiancheria da balcone estensibile

**Categoria** Acciaio trattato con polveri epossidiche  
**Dove** Per esterni  
**Quanto** 20 m  
**Perché** La griglia telescopica permette di aumentare la metratura del bucato steso. Da 110 a 190 cm con un solo gesto

## The only extendible clothes dryer for balconies

**Category** Steel treated with epoxy powders  
**Where** Outdoors  
**What size** 20 m  
**Why** The telescopic rack lets you hang more washing out to dry. 110 to 190 cm in just one movement

## Der einzige erweiterbare Balkon-Wäscheständer

**Material** Stahl, epoxidpulverbeschichtet  
**Standort** Für Aussen  
**Leinenlänge** 20 m  
**Merkmale** Durch das Teleskopgitter kann eine größere Menge von Wäschestücken aufgehängt werden. Mit einem einzigen Handgriff von 110 bis 190 cm

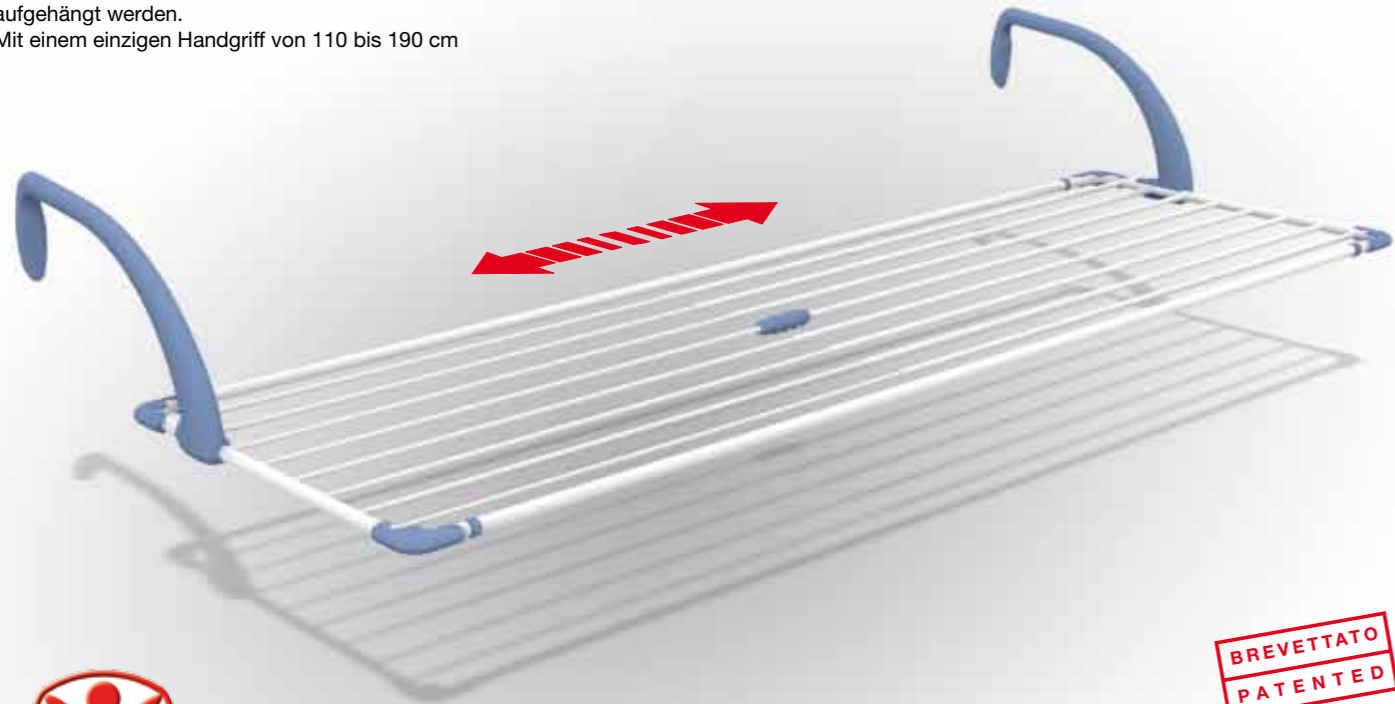

BREVETTATO  
PATENTED

## Le seul séchoir à linge extensible pour balcon

**Catégorie** Acier traité par des poudres époxy  
**Où** A l'extérieur  
**Combien** 20 m  
**Pourquoi** Sa grille télescopique permet d'augmenter le métrage du linge étendu. De 110 à 190 cm en un seul geste

## El único tendedero extensible para balcon

**Categoría** Acero tratado con polvos epoxídicos  
**Dónde** Para exteriores  
**Cuánto** 20 m  
**Porqué** Su parrilla telescópica permite aumentar la extensión de la ropa que se debe tender. De 110 a 190 cm en un solo movimiento



# Stendissimo

## La sua griglia raddoppia con un solo gesto!

**Categoria** Acciaio verniciato  
**Dove** Ideale in ogni ambiente  
**Quanto** Fino a 20 m  
**Perché** Griglia estensibile da 108 a 187 cm per soddisfare ogni esigenza di bucato. È completo di ruote e accessori in plastica per stendere piccoli capi come fazzoletti e calzini. Snodo di sicurezza per evitare una chiusura accidentale collocato sulla gamba

## Just one movement to obtain a double rack!

**Category** Painted steel  
**Where** Ideal in every environment  
**What size** Up to 20 m  
**Why** Extensible from 108 to 187 cm to meet any requirement. It is complete with wheels and plastic accessories for drying small items such as handkerchiefs or socks. Safety joint to avoid accidental closure on the leg

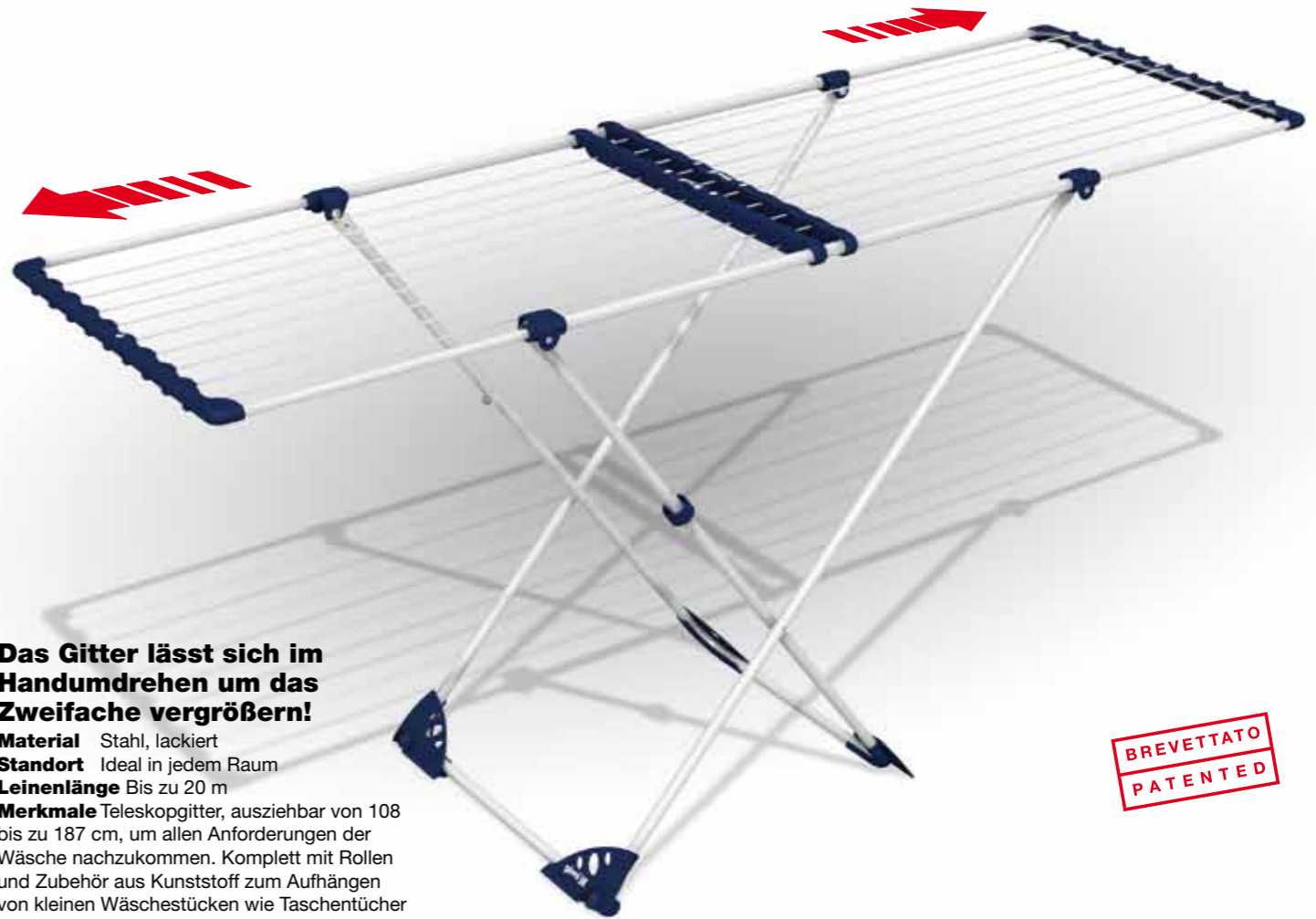

## Das Gitter lässt sich im Handumdrehen um das Zweifache vergrößern!

**Material** Stahl, lackiert  
**Standort** Ideal in jedem Raum  
**Leinenlänge** Bis zu 20 m  
**Merkmale** Teleskopgitter, ausziehbar von 108 bis zu 187 cm, um allen Anforderungen der Wäsche nachzukommen. Komplett mit Rollen und Zubehör aus Kunststoff zum Aufhängen von kleinen Wäschestücken wie Taschentücher oder Socken. Sicherheitsgelenk am Bein, um ein unvorgesehenes Schließen zu vermeiden

BREVETTATO  
PATENTED

## Un seul geste et la grille est double !

**Catégorie** Acier peint  
**Où** Pour n'importe quelle pièce  
**Combien** Jusqu'à 20 m  
**Pourquoi** Grille extensible de 108 à 187 cm pour satisfaire toute nécessité. Il est pourvu de roues et accessoires en plastique pour étendre de petites pièces de linge (mouchoirs et chaussettes). Joint de sécurité contre toute fermeture accidentelle sur la jambe

## ¡Un solo movimiento para que su rejilla duplique su tamaño!

**Categoría** Acero barnizado  
**Dónde** Ideal para cualquier ambiente  
**Cuánto** Hasta 20 m  
**Porqué** Parrilla extensible de 108 a 187 cm para satisfacer toda exigencia de tendido. Incluye ruedas y accesorios de plástico para tender prendas pequeñas, como pañuelos o medias. Articulación de seguridad incorporada en la pata para impedir su cierre accidental

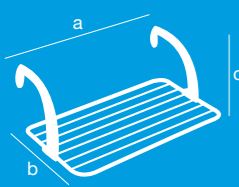

Item	Gimi	Ean	m	1 pz	kg	axbxc=cm	axbxc=cm	axbxc=cm	n° pz	n° pz	h=cm	n° pz
Brezza Extend	10760600	8001244006539	20	3,5	15	192x55x30	55x5x120,5	58x15x123	4	40	138	37

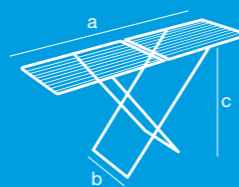

Item	Gimi	Ean	m	1 pz	kg	axbxc=cm	axbxc=cm	axbxc=cm	n° pz	n° pz	h=cm	n° pz
Stendissimo	10761900	8001244010208	20	4,2	25	187x57x94	57x6,4x131,5	59,5x15x133,5	3	30	148,5	25

# Albatross

## Allarga le ali telescopiche e stendi tutto il tuo bucato!

**Categoria** Acciaio trattato con polveri epossidiche  
**Dove** Per ogni tipo di ambiente, esterno e interno  
**Quanto** 20 m  
**Perché** La telescopicità delle prolunghe rende anche questo stendibiancheria gimi "estensibile", ovvero adattabile istantaneamente alle esigenze di spazio del cliente. I copriannelli in resina consentono di appendere ben 36 piccoli capi (fazzoletti, calzini, biancheria intima) lasciando liberi i fili per il bucato di maggiori dimensioni

## Open the telescopic wings and hang all your clothes!

**Category** Steel treated with epoxy powders  
**Where** For any kind of environment, indoors or out  
**What size** 20 m  
**Why** Thanks to its telescopic wings, this clothes-drier from gimi is truly "extensible" and instantaneously fits any customer's need. Moreover, thanks to its resin ring covers, as many as 36 small pieces can be hung out (handkerchiefs, socks, underwear), thus leaving the lines free for larger ones.

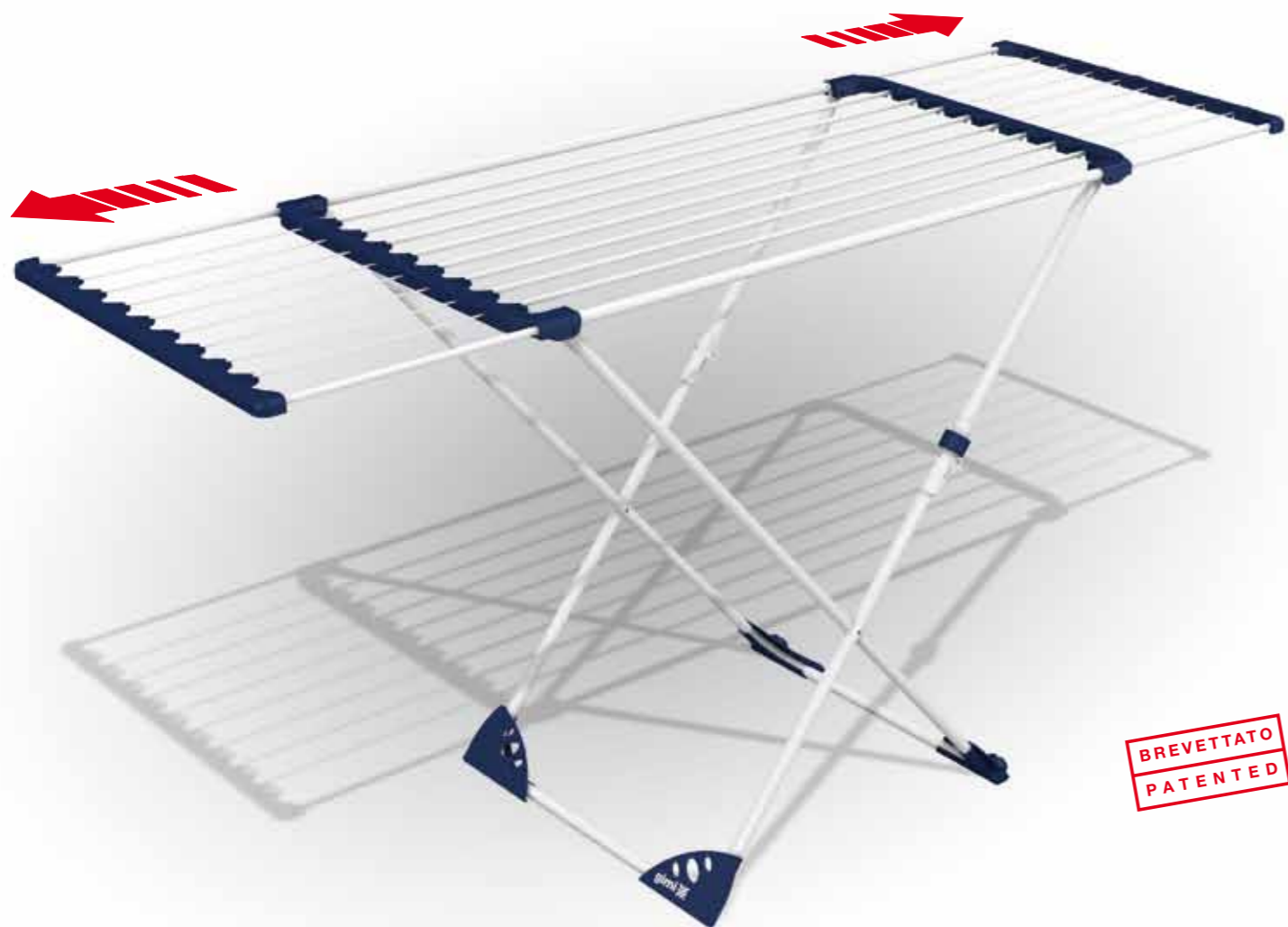

BREVETTATO  
PATENTED

## Breite die Teleskopflügel aus und hänge die ganze Wäsche auf!

**Material** Epoxidpulverbeschichteter Stahl  
**Standort** Für jeden Raum geeignet, für innen und außen  
**Leinenlänge** 20 m  
**Merkmale** Die Ausziehbarkeit der Flügel macht auch diesen Wäscheständer gimi verlängerbar bzw. bequem den Bedürfnissen des Kunden anpassbar. Die Ringabdeckungen aus Kunstharz ermöglichen das Aufhängen von bis zu 36 kleinen Wäscheteilen (Taschentücher, Socken, Unterwäsche), wodurch noch genug Platz für die größere Wäsche vorhanden ist

## Ouvrez les rallonges télescopiques et séchez tout votre linge!

**Catégorie** Acier traité par des poudres époxy  
**Où** Pour n'importe quelle pièce. Aussi bien à l'intérieur qu'à l'extérieur  
**Combien** 20 m  
**Pourquoi** Grâce aux rallonges télescopiques, ce séchoir/étendoir gimi est réellement «extensible», c'est-à-dire qu'il s'adapte instantanément aux exigences d'espace du client. Les protège-anneaux en résine permettent de suspendre 36 petits vêtements (mouchoirs, chaussettes, lingerie) en laissant les fils libres pour le linge plus grand

## ¡Alarga las alas telescópicas y cuelga toda tu colada!

**Categoría** Acero tratado con polvos epoxídicos  
**Dónde** Para todo tipo de espacio, exterior e interior  
**Cuánto** 20 m  
**Porqué** La telescopicidad de las extensiones hace que este tendedero gimi sea "extensible", es decir, se adapta instantáneamente a las exigencias de espacio del cliente. Los cubre-anillos en resina permiten tender hasta 36 prendas pequeñas (pañuelos, calcetines, ropa íntima), dejando las cuerdas libres para las prendas más grandes

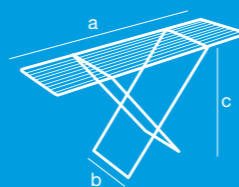
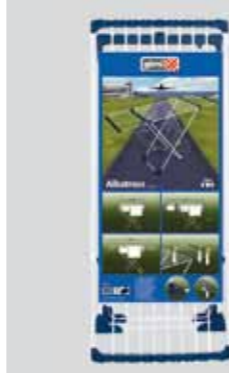

Aperto  
Open

Chiuso  
Folded



Item	Gimi	Ean	m	1 pz	kg	axbxc=cm	axbxc=cm	axbxc=cm	n° pz	n° pz	h=cm	n° pz
Albatross	10021060	8001244007581	20	4,5	25	188x56x94	56x5,5x132	58,5x12,5x133,5	3	36	148,5	30

# Extension

## Lo accorci e lo allunghi come vuoi!

**Categoria** Acciaio verniciato  
**Dove** Ideale in ogni ambiente  
**Quanto** Fino a 20 m  
**Perché** Griglia telescopica estensibile da 107 a 180 cm, per soddisfare ogni esigenza di bucato; completo di ruote ed accessori in plastica per stendere piccoli capi come fazzoletti o foulard, apertura e chiusura di estrema facilità grazie allo snodo sulla gamba

## As long or short as you want!

**Category** Painted steel  
**Where** For any kind of environment  
**What size** Up to 20 m  
**Why** Telescopic rack, extendable from 107 to 180 cm, to meet any requirement for washing; complete with wheels and plastic accessories for drying small items such as handkerchiefs or headscarves. It is very easy to open and close thanks to the practical leg joint

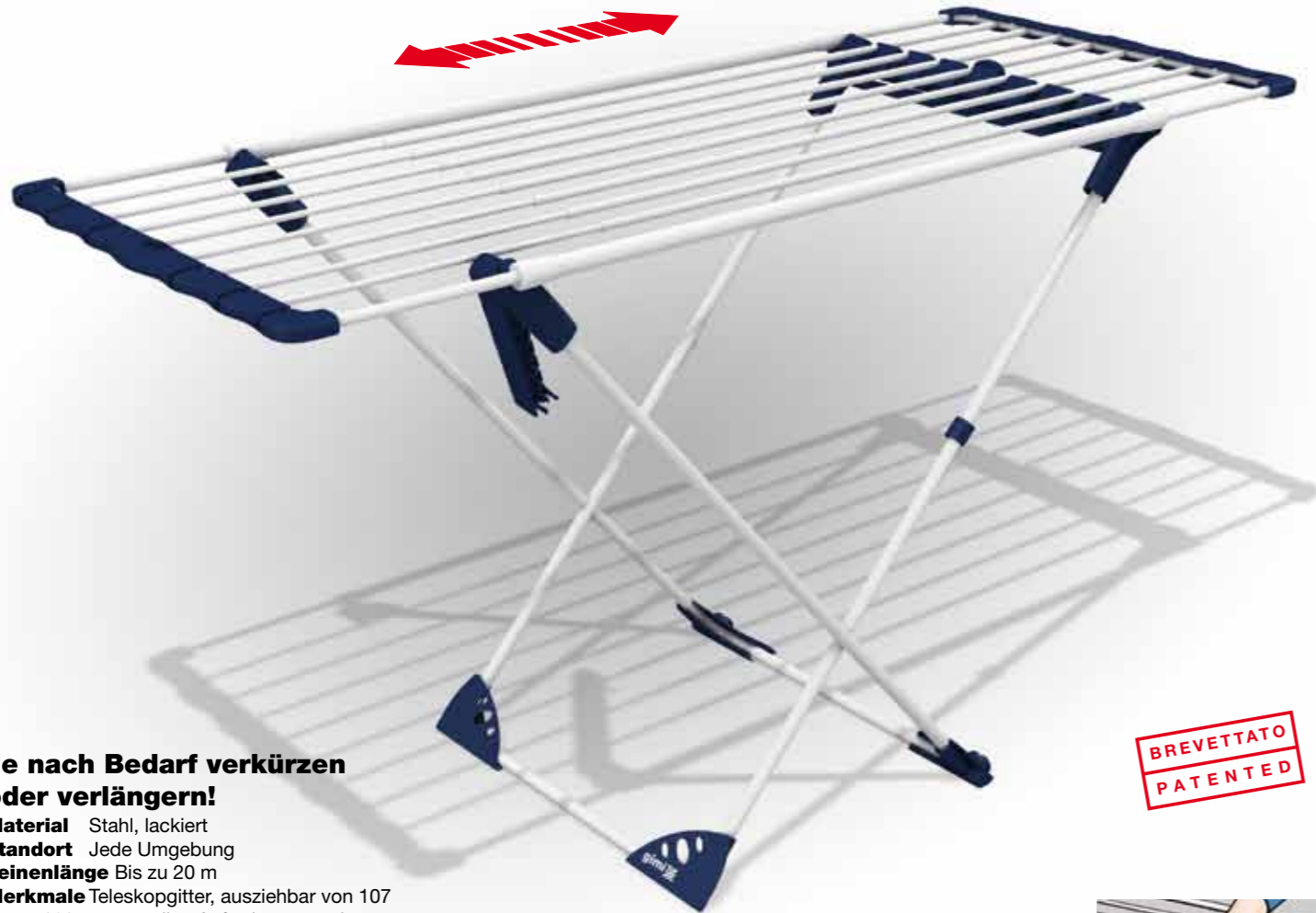

## Je nach Bedarf verkürzen oder verlängern!

**Material** Stahl, lackiert  
**Standort** Jede Umgebung  
**Leinenlänge** Bis zu 20 m  
**Merkmale** Teleskopgitter, ausziehbar von 107 bis zu 180 cm, um allen Anforderungen der Wäsche nachzukommen; komplett mit Rollen und Zubehör in Kunststoff zum Aufhängen von kleinen Wäschestücken wie Taschentücher oder Halstücher; das Öffnen und Schließen ist durch das Beingelenksystem extrem einfach

## Vous pouvez le raccourcir ou l'allonger à votre gré!

**Catégorie** Acier peint  
**Où** Pour n'importe quelle pièce  
**Combien** Jusqu'à 20 m  
**Pourquoi** Grille télescopique extensible, de 107 à 180 cm, pour satisfaire toute nécessité. Il est pourvu de roues et accessoires en plastique pour étendre de petites pièces de linge (mouchoirs ou foulards), ouverture et fermeture très aisées grâce au joint sur la jambe

## ¡Lo acortas y lo alargas cómo tu quieras!

**Categoría** Acero pintado  
**Dónde** Ideal para todo tipo de ambiente  
**Cuánto** Hasta 20 m  
**Porqué** Parrilla telescópica extensible de 107 a 180 cms, para satisfacer cualquier necesidad. Lleva ruedas y accesorios de plástico para tender pequeñas prendas (pañuelos, calcetines). Fácil de abrirlo y cerrarlo gracias a la bisagra en la estructura

BREVETTATO  
 PATENTED

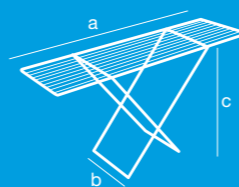

Item	Gimi	Ean	m	1 pz	kg	axbxc=cm	axbxc=cm	axbxc=cm	n° pz	n° pz	h=cm	n° pz
Extension	10250050	8001244006188	20	5,35	25	180x57x94	57x7,5x131,5	59x14,5x134,5	3	30	149,5	26



# Dinamik 20

**L'unico che vale per due.  
Dinamik: lo stendibiancheria  
estensibile, ideato e  
brevettato da gimì.**

**Category** Acciaio trattato con polveri epossidiche  
**Dove** Ideale in ogni ambiente  
**Quanto** 20 m  
**Perché** Fili telescopici estensibili da 110 a 190 cm, per adattarli alle dimensioni del bucato, dai piccoli capi fino alle lenzuola

**The only dryer that is two-in-one.  
Dinamik: the extensible  
clothes-dryer designed and  
patented by gimì.**

**Category** Steel treated with epoxy powders  
**Where** Ideal in every environment  
**What size** 20 m  
**Why** Telescopic lines that can extend from 110 to 190 cm, so it can be adapted to the dimensions of the washing, from small garments to bedclothes

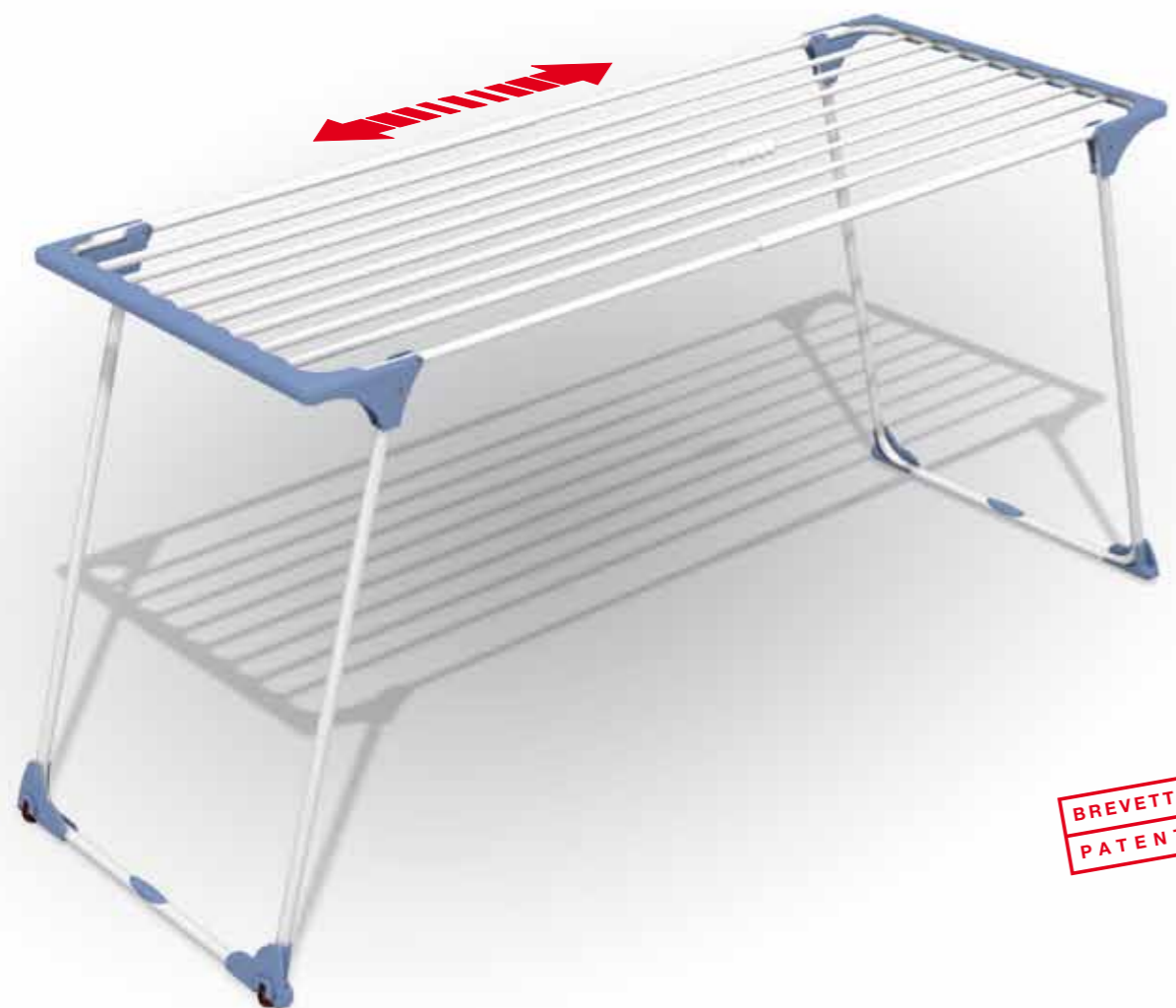

BREVETTATO  
PATENTED

**Zwei in Einem.  
Dinamik: der erweiterbare  
Wäscheständer, von gimì  
erfunden und patentiert.**

**Material** Stahl, epoxidpulverbeschichtet  
**Standort** Ideal für jede Umgebung  
**Leinenlänge** 20 m  
**Merkmale** Ausziehbare Teleskopdrähte von 110 bis 190 cm, anpassbar an die jeweiligen Maße der Wäsche, von kleinen Kleidungsstücken bis zu Betttüchern

**Un seul pour un double emploi.  
Dinamik : Le séchoir/étendoir  
extensible, conçu et breveté  
par gimì**

**Catégorie** Acier traité par des poudres époxy  
**Où** Pour n'importe quelle pièce  
**Combien** 20 m  
**Pourquoi** Fils télescopiques extensibles de 110 à 190 cm, pour les adapter aux dimensions du linge, des vêtements très petits jusqu'aux draps

**El único que vale por dos.  
Dinamik: el tendedero  
extensible, ideado y  
patentado por gimì**

**Categoría** Acero tratado con polvos epoxídicos  
**Dónde** Ideal para todo tipo de ambiente  
**Cuánto** 20 m  
**Porqué** Hilos telescópicos extensibles de 110 a 190 cm, para adaptarlos a las dimensiones de la ropa, desde las prendas pequeñas hasta las sábanas

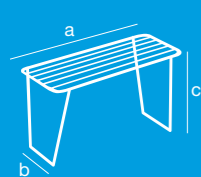

Aperto  
Open

Chiuso  
Folded



Item	Gimì	Ean	m	1 pz	kg	axbxc=cm	axbxc=cm	axbxc=cm	n° pz	n° pz	h=cm	n° pz
Dinamik 20	10140002	8001244001282	20	4,60	20	188x57x100	57x9x116	58x14x119,5	2	24	134,5	20

# Dinamik 30

**Category** Acciaio trattato con polveri epossidiche  
**Come** Con prolunghe laterali  
**Dove** Ideale in ogni ambiente  
**Quanto** 28 m  
**Perché** Fili telescopici estensibili da 110 a 190 cm, per adattarli alle dimensioni del bucato, dai piccoli capi fino alle lenzuola

**Material** Stahl, epoxidpulverbeschichtet  
**Ausstattung** Mit seitlichen Erweiterungen  
**Standort** Ideal für jede Umgebung  
**Leinenlänge** 28 m  
**Merkmale** Ausziehbare Teleskopdrähte von 110 bis 190 cm, anpassbar an die jeweiligen Maße der Wäsche, von kleinen Kleidungsstücken bis zu Betttüchern

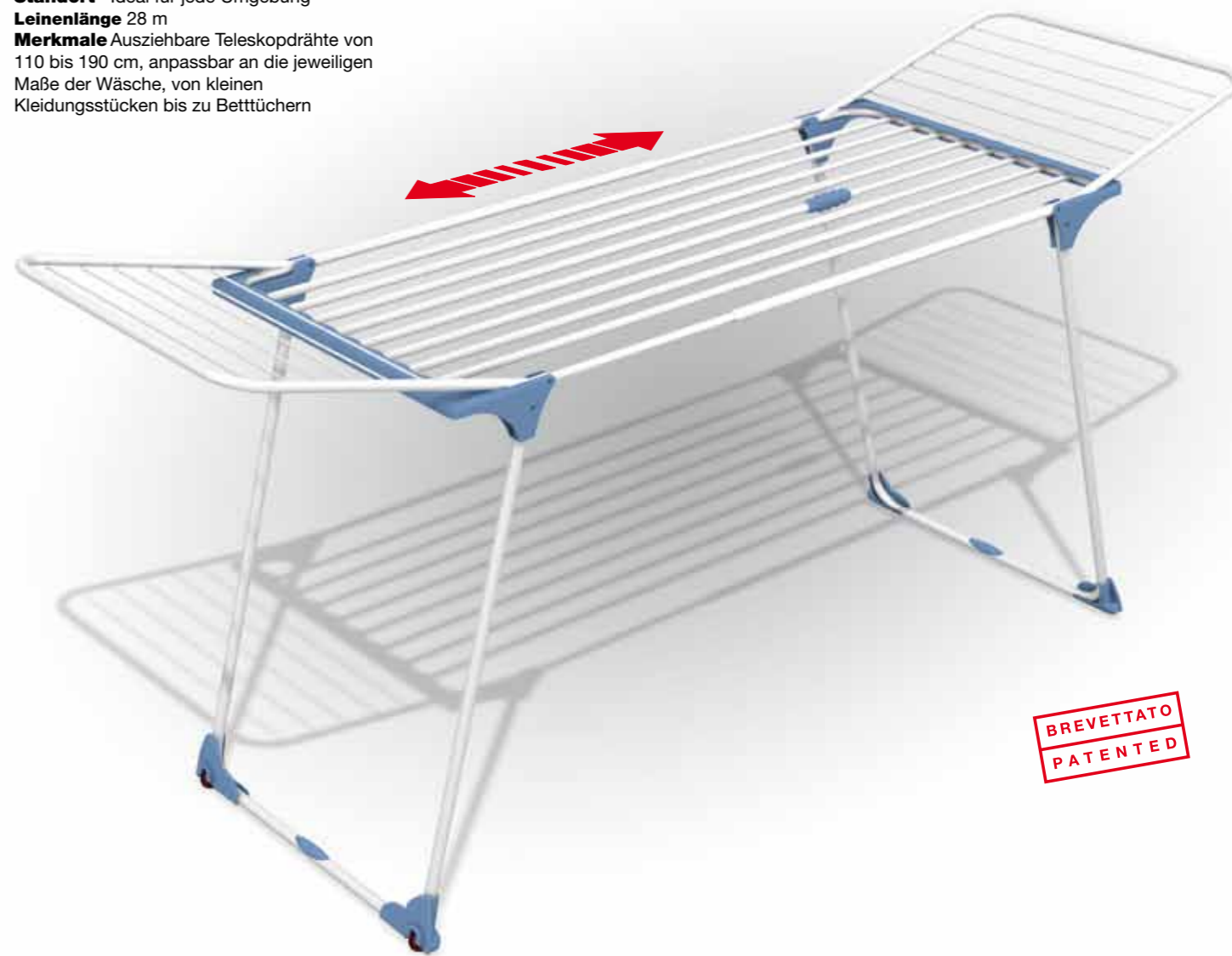

BREVETTATO  
PATENTED

**Catégorie** Acier traité par des poudres époxy  
**Comment** Avec les rallonges latérales  
**Où** Pour n'importe quelle pièce  
**Combien** 28 m  
**Pourquoi** Fils télescopiques extensibles de 110 à 190 cm, pour les adapter aux dimensions du linge, des vêtements très petits jusqu'aux draps

**Categoría** Acero tratado con polvos epoxídicos  
**Cómo** Con extensiones laterales  
**Dónde** Ideal para todo tipo de ambiente  
**Cuánto** 28 m  
**Porqué** Hilos telescópicos extensibles de 110 a 190 cm, para adaptarlos a las dimensiones de la ropa, desde las prendas pequeñas hasta las sábanas

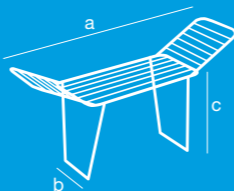

Aperto  
Open

Chiuso  
Folded



Item	Gimì	Ean	m	1 pz	kg	axbxc=cm	axbxc=cm	axbxc=cm	n° pz	n° pz	h=cm	n° pz
Dinamik 30	10140032	8001244004290	28	5,35	30	270x57x100	57x10,5x116	60x15,5x119	2	20	134	18

# Dinamik 30 Color



## Stendi tutto, dalle lenzuola alle scarpe!

**Come** con accessorio stendi-scarpe  
**Quanto** 28 m  
**Perché** Fili telescopici estensibili da 110 a 190 cm, per adattarli alle dimensioni del bucato, dai piccoli capi fino alle lenzuola

## Hängen Sie alles auf, von den Betttüchern bis zu den Schuhen!

**Ausstattung** mit Schuh-Aufhängevorrichtung  
**Leinenlänge** 28 m  
**Merkmale** Ausziehbare Teleskopdrähte von 110 bis 190 cm, anpassbar an die jeweiligen Maße der Wäsche, von kleinen Kleidungsstücken bis zu Betttüchern

## Hang everything, from sheets to shoes!

**How** with shoe hanger accessory  
**What size** 28 m  
**Why** Telescopic lines that can extend from 110 to 190 cm, so it can be adapted to the dimensions of the washing, from small garments to bedclothes

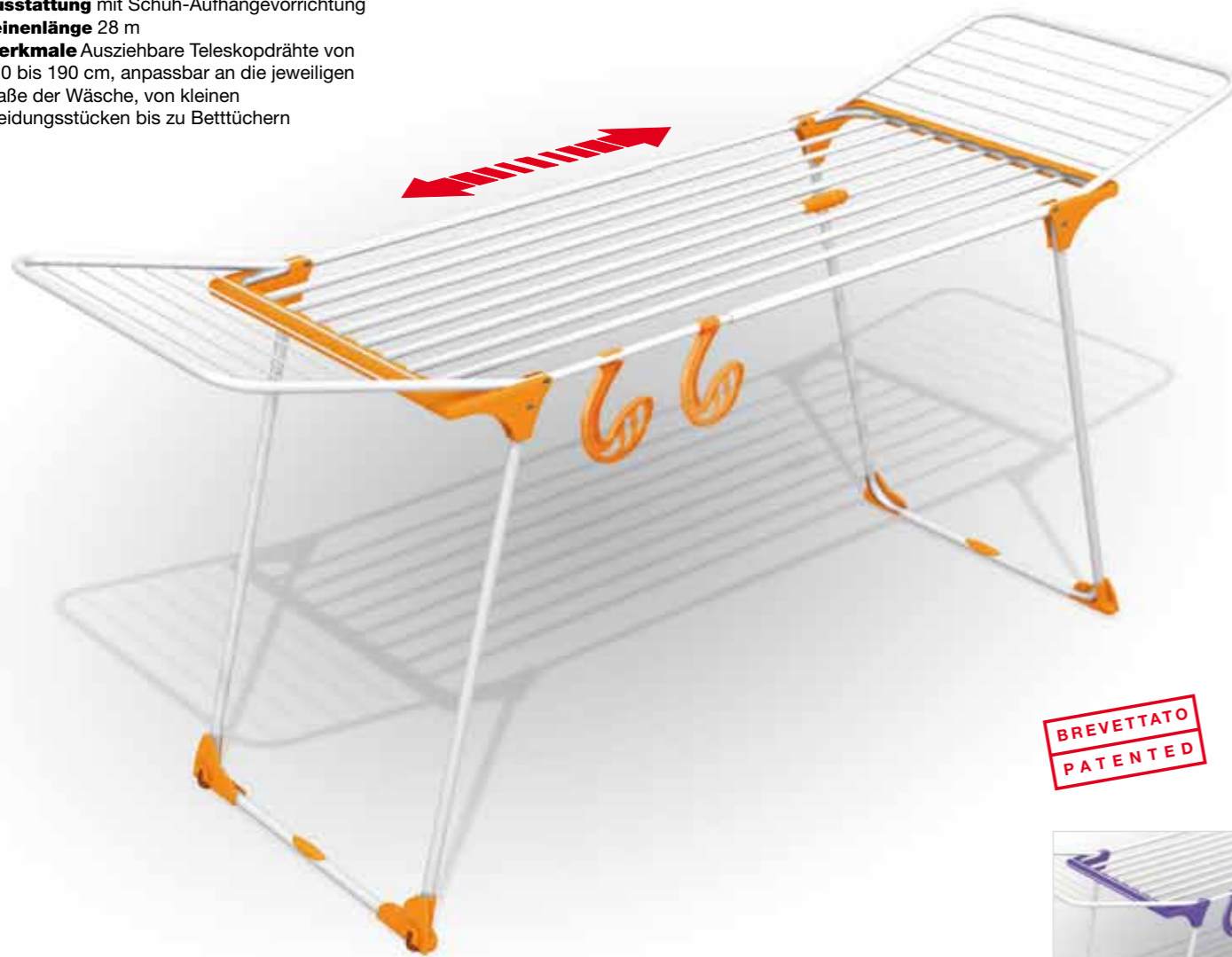

BREVETTATO  
PATENTED



## Pour sécher tout type de linge, à partir des draps jusqu'aux chaussures!

**Comment** avec accessoire pour chaussures  
**Combien** 28 m  
**Pourquoi** Fils télescopiques extensibles de 110 à 190 cm, pour les adapter aux dimensions du linge, des vêtements très petits jusqu'aux draps

## Para tender de todo... ¡desde las sábanas hasta los zapatos!

**Cómo** con accesorio para calzado  
**Cuánto** 28 m  
**Porqué** Hilos telescópicos extensibles de 110 a 190 cm, para adaptarlos a las dimensiones de la ropa, desde las prendas pequeñas hasta las sábanas

# Duplo

## Uno stendibiancheria, anzi due

**Categoria** Acciaio trattato con polveri epossidiche  
**Dove** In casa e fuori  
**Quanto** 18 m  
**Perché** Uno stendibiancheria che consente di staccare una delle prolunghe per collocarla sul balcone. Una possibilità di scelta in più.

## The multiple clothes-drier

**Category** Steel treated with epoxy powders  
**Where** Indoors and outdoors  
**What size** 18 m  
**Why** One extension can be removed and attached to the balcony: a valuable additional option



## Zwei Wäscheständer in Einem

**Material** Stahl, epoxidpulverbeschichtet  
**Standort** Für innen und außen  
**Leinenlänge** 18 m  
**Merkmale** Eine der beiden Verlängerungen des Wäscheständers ist abnehmbar und kann auf dem Balkon angebracht werden und bietet somit einen weiteren praktischen Vorteil

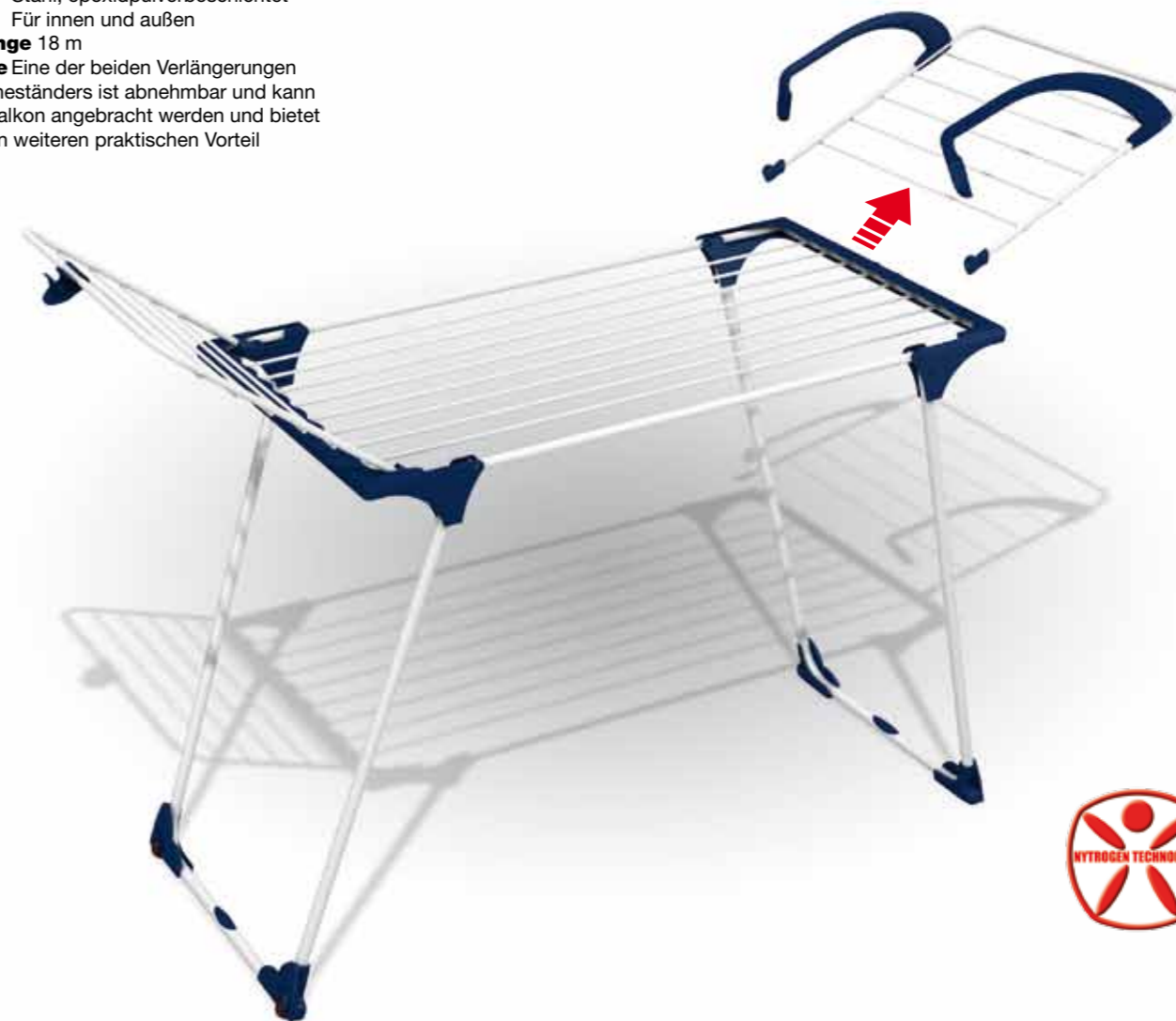

## L'étendoir multiple

**Catégorie** Acier traité par des poudres époxy  
**Où** Aussi bien à l'intérieur qu'à l'extérieur  
**Combien** 18 m  
**Pourquoi** Une rallonge peut être détachée et fixée au balcon : un plus incomparable

## Un tendedero, o más bien, dos

**Categoría** Acero tratado con polvos epoxídicos  
**Dónde** En casa o en el exterior  
**Cuánto** 18 m  
**Porqué** Un tendedero que permite quitar una de las dos extensiones para colgarla en el balcón. Una posibilidad más

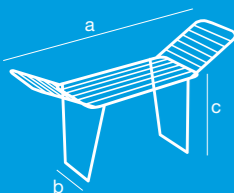

Aperto  
Open

Chiuso  
Folded



Item	Gimi	Ean	m	1 pz	kg	axbxc=cm	axbxc=cm	axbxc=cm	n° pz	n° pz	h=cm	n° pz
Dinamik 30 Color	10140045	8001244010642	28	5,35	30	270x57x100	57x10,5x117	60x15,5x119	2	20	134	18

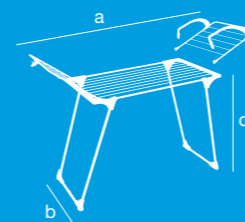

Aperto  
Open

Chiuso  
Folded



Item	Gimi	Ean	m	1 pz	kg	axbxc=cm	axbxc=cm	axbxc=cm	n° pz	n° pz	h=cm	n° pz
Duplo	10166200	8001244007505	18	3,35	17	174x56x91	56x10x108	60x20,5x109	3	24	124	22

# Stendibiancheria a torre

# Vip

## Tutto il bucato comodamente steso nel box doccia!

**Perché** Per chi non vuole rinunciare alla comodità di stendere nel box doccia, ma è attento anche alla convenienza

## All your washing hung out to dry, out of the way in the shower cubicle!

**Why** For those who like the practicality of being able to hang out washing in the shower cubicle, at just the right price



Materiale Material		Nome prodotto Item	Plus			
			Ruote piroettanti Pivoting wheels	Fissaggio griglie anticaduta Anti accidental falling racks	Modulabile a metà Half adjustable	Supporti per grucce Hooks for hangers
Acciaio Steel	m 30	Vip 3	✓			
		Modular 3	✓	✓	✓	✓
	m 40	Vip 4	✓			
		Modular 4	✓	✓	✓	✓



## Alle Wäsche bequem in der Duschkabine aufgehängt!

**Merkmale** Ideal zur bequemen Anwendung in Duschkabinen und gleichzeitig preiswert

## Très pratique pour la cabine de douche!

**Pourquoi** Pour ceux qui ne souhaitent pas renoncer à étendre le linge dans la cabine de douche mais qui prêtent aussi attention aux avantages économiques

## ¡Toda la ropa lavada cómodamente tendida en el box ducha!

**Porqué** Para quien no desea renunciar a la comodidad de tender en el box ducha pero cuida también la conveniencia



Per descrizioni dettagliate consultare le pagine dei singoli prodotti.  
For more details please see the related product pages.



Item	Gimi	Ean	m	1 pz	kg	axbxc=cm	axbxc=cm	axbxc=cm	n° pz	n° pz	h=cm	n° pz
Polo 30 Vip	10516380	8001244105805	30	3,60	20	70,5x70,5x131	70,5x4,5x127,5	72x13x129	4	36	144	33
Polo 40 Vip	10516480	8001244104488	40	4,60	25	70,5x70,5x168	70,5x4,5x163,5	72x13x166	4	36	181	25

# Modular 3

**Poco ingombro, tanto bucato. Lo usi anche chiuso a metà!**

**Categoria** Acciaio trattato con polveri epossidiche  
**Dove** Per esterno e anche nei box doccia  
**Quanto** 30 m  
**Perché** Stende tantissimo in pochissimo spazio, completo di ruote e due supporti per grucce

**Wenig platzraubend, viel Wäsche.**

**Auch halbgeöffnet nutzbar.**

**Material** Stahl, epoxidpulverbeschichtet  
**Standort** Außen und auch in Duschkabinen  
**Leinenlänge** 30 m  
**Merkmale** Viel aufgehängte Wäsche auf kleinstem Raum, mit Rollen und zwei Halterungen für Kleiderbügel



**Encombrement réduit, grande capacité d'étendage.**

**Possibilité de n'utiliser qu'une demi-ouverture en cas d'espace restreint**

**Matière** Acier traité par des poudres époxy  
**Où** A l'extérieur mais aussi dans les cabines de douche  
**Combien** 30 m  
**Pourquoi** Pour étendre beaucoup de linge en très peu d'espace. Il est pourvu de roues et de deux supports pour les cintres

**Poco estorbo, mucha colada. ¡Lo puedes utilizar incluso cerrado por la mitad!**

**Categoría** Acero tratado con polvos epoxídicos  
**Dónde** Para exteriores y también para box ducha  
**Cuánto** 30 m  
**Porqué** Permite tender tantas prendas en poquísimo espacio, incluye ruedas y dos soportes para perchas



# Modular 4

**Categoria** Acciaio trattato con polveri epossidiche  
**Dove** Per esterno e anche nei box doccia  
**Quanto** 40 m  
**Perché** Stende tantissimo in pochissimo spazio, completo di ruote e due supporti per grucce

**Material** Stahl, epoxidpulverbeschichtet  
**Standort** Außen und auch in Duschkabinen  
**Leinenlänge** 40 m  
**Merkmale** Viel aufgehängte Wäsche auf kleinstem Raum, mit Rollen und zwei Halterungen für Kleiderbügel

**Category** Steel treated with epoxy powders  
**Where** Outdoors, and also in the shower cubicle  
**What size** 40 m  
**Why** You can dry a lot of washing in very little space, complete with wheels and two hooks for hangers

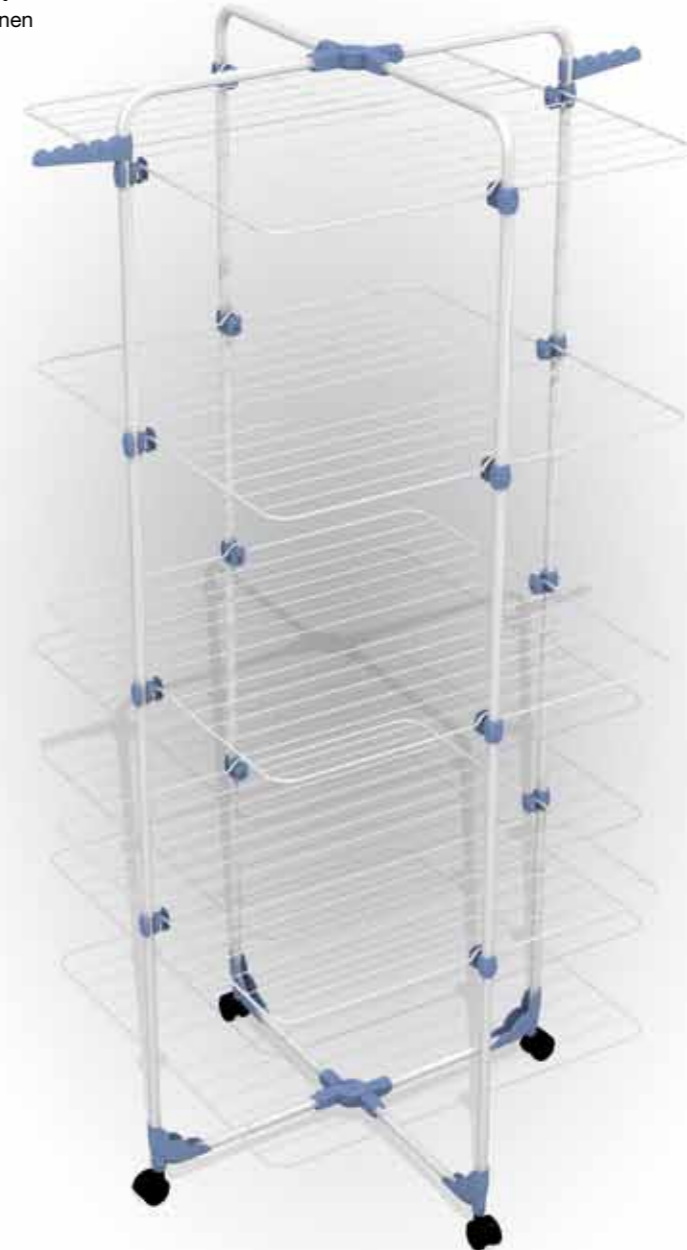

**Matière** Acier traité par des poudres époxy  
**Où** A l'extérieur mais aussi dans les cabines de douche  
**Combien** 40 m  
**Pourquoi** Pour étendre beaucoup de linge en très peu d'espace. Il est pourvu de roues et de deux supports pour les cintres

**Categoría** Acero tratado con polvos epoxídicos  
**Dónde** Para exteriores y también para box ducha  
**Cuánto** 40 m  
**Porqué** Permite tender tantas prendas en poquísimo espacio, incluye ruedas y dos soportes para perchas



Item	Gimi	Ean	m	1 pz	kg	axbxc=cm	axbxc=cm	axbxc=cm	n° pz	n° pz	h=cm	n° pz
Modular 3 Lux	10510290	8001244123007	30	3,80	20	71x71x132	71x5x127,5	74x20x129	4	24	144	20

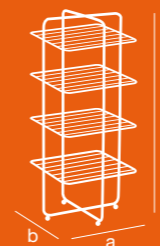

Item	Gimi	Ean	m	1 pz	kg	axbxc=cm	axbxc=cm	axbxc=cm	n° pz	n° pz	h=cm	n° pz
Modular 4 Lux	10510390	8001244124004	40	4,75	25	71x71x168,5	71x5x163,5	71,5x19x166	4	24	181	17

# Stendibiancheria da balcone, vasca e termosifone

## Mistral

**Perché** Con prolunga a ribalta, per stendere 8 m sul balcone

**Why** With hinged extension, to hang out 8 m of washing on the balcony

**Merkmale** Mit Klappverlängerung, Leinenlänge 8, zum Aufhängen der Wäsche auf dem Balkon

**Pourquoi** Il est pourvu de rallonge abattante pour étendre 8 m de linge sur le balcon

**Porqué** Con extensión abatible, permite tender hasta 8 m en el balcón

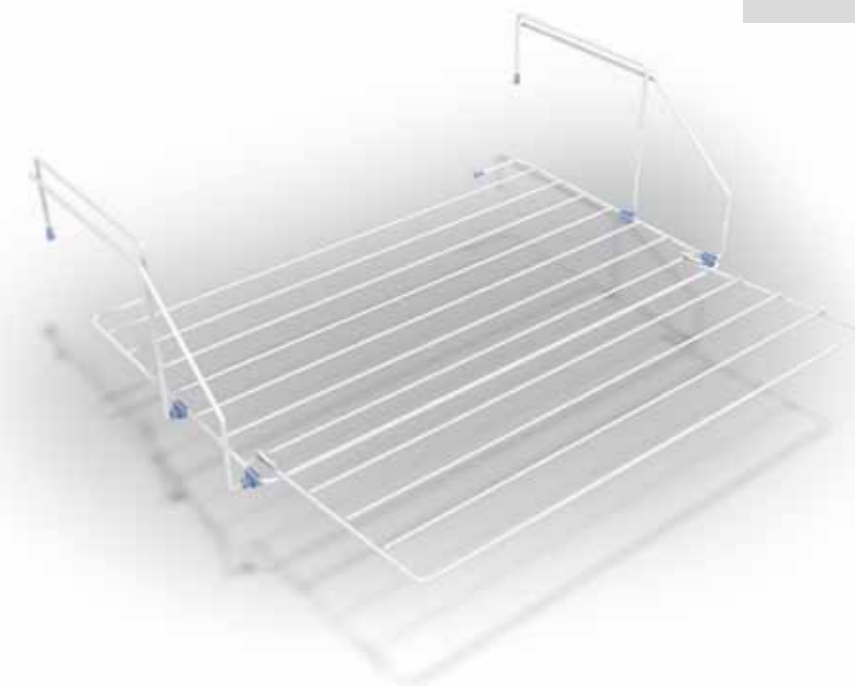

Balcone / Balcony					
Materiale Material	Icona	Nome prodotto Item	Plus		
			Esclusiva Gimi Gimi exclusive	Rivestimenti particolari* Special coverings*	Altro Other
Acciaio Steel	m 8	Mistral		✓	prolunga a ribalta hinged extension
Acciaio / resina Steel / resin	m 10	Polar		✓	
	m 5	Brezza 60	✓	✓	
	m 10	Brezza 100	✓	✓	
	m 18	Brezza 200	✓	✓	prolunghe laterali lateral extensions
Inox / resina Inox / resin	m 10	Brezza 100 Inox	✓		
Alluminio / resina Aluminium / resin	m 10	Brezza 100 Alu	✓		
Resina Resin	m 10	Ghibli			
	m 10	Virgola	✓		
Acciaio zincato Zincplated steel	m 20	Ring		✓	3 posizioni 3 positions estensione fino a 5 mt extension up to 5 mt

Vasca/termosifone / Bath/radiator					
Materiale Material	Icona	Nome prodotto Item	Plus		
			Esclusiva Gimi Gimi exclusive	Rivestimenti particolari* Special coverings*	Altro Other
Acciaio Steel	m 10	Alablock		✓	
Alluminio / resina Aluminium / resin	m 2	Pallino	✓		vaschetta per umidificare humidificator tank 2 posizioni 2 positions
Acciaio Steel	m 2,5	Lampo		✓	
Acciaio / resina Steel / resin	m 3	Quick		✓	
	m 3	Airy	✓	✓	
Resina Resin	m 3,5	Pliko	✓		

## Polar

**Categoria** Acciaio trattato con polveri epossidiche

**Quanto** 10 m

**Material** Stahl, epoxidpulverbeschichtet  
**Leinenlänge** 10 m

**Categoria** Acero tratado con polvos epoxídicos  
**Cuánto** 10 m

**Category** Steel treated with epoxy powders  
**What size** 10 m

**Matière** Acier traité par des poudres époxy  
**Combien** 10 m

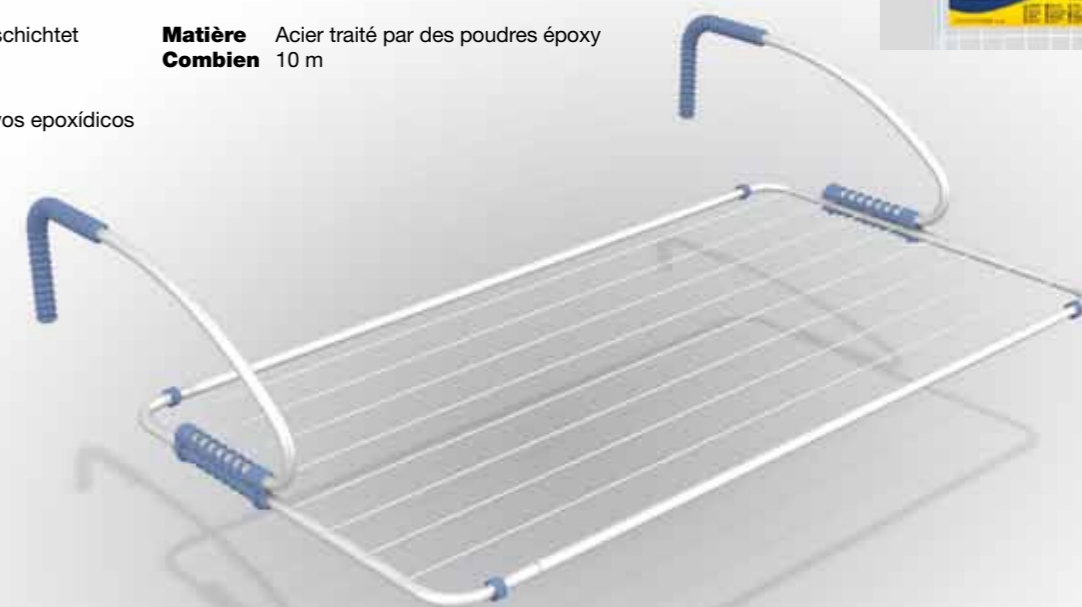

= Nitrogen Technology

\*Per descrizioni dettagliate consultare le pagine dei singoli prodotti.  
For more details please see the related product pages.

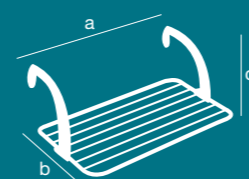

Item	Gimi	Ean	m	1 pz	kg	axbxc=cm	axbxc=cm	axbxc=cm	n° pz	n° pz	h=cm	n° pz
Mistral	10505000	8001244876002	8	1,18	7	56x63x25	39,5x3x60	41x22x62	12	240	139	214
Polar 100	10070002	8001244880009	10	1,35	10	106,5x4,5x106,5	55,5x4,5x106,5	56,5x19,5x110	6	48	125	49

# Brezza 60

## Il più amato, in tutti i suoi formati!

**Dove** Per esterni  
**Perché** Stretto e lungo, stende fino a 5 m sfruttando ogni spazio

## The most popular, in all sizes!

**Where** Outdoors  
**Why** Narrow and long, it extends to up to 5 m, to use all the available space

## Der Beliebteste, in allen Größen verfügbar!

**Standort** Für Aussen  
**Merkmale** Schmal und lang, bis zu 5 m Leinenlänge, für alle Platzbedingungen

## Le plus aimé, dans tous ses formats!

**Où** A l'extérieur.  
**Pourquoi** Étroit et long, pour étendre jusqu'à 5 m de linge et profiter de tout l'espace disponible

## ¡El preferido, en todos sus formatos!

**Dónde** Para exteriores  
**Porqué** Estrecho y largo, permite tender hasta 5 m aprovechando integralmente el espacio

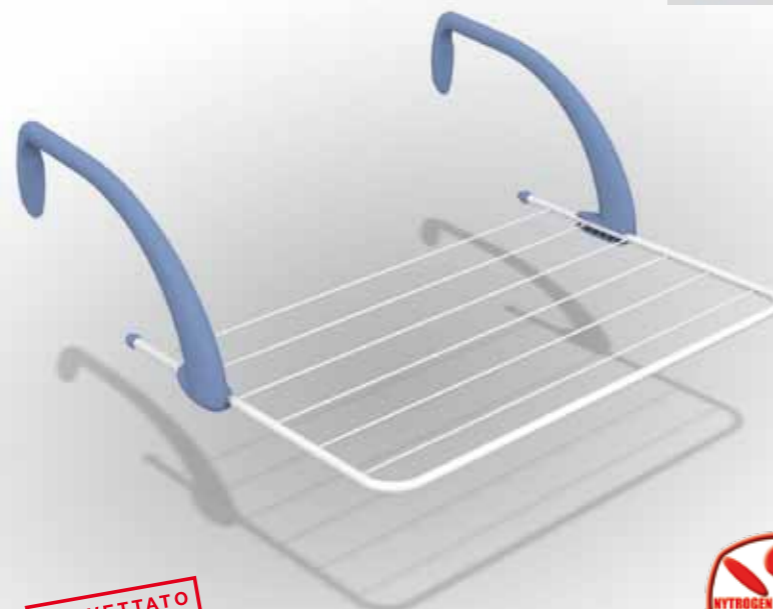

BREVETTATO  
PATENTED



# Brezza 100 Inox/Aluminium

## Perfetto per il balcone, inattaccabile dalla ruggine!

**Dove** Per esterni  
**Quanto** 10 m  
**Perché** Eccezionale resistenza agli agenti atmosferici

## Perfect for the balcony, rustproof!

**Where** Outdoors  
**What size** 10 m  
**Why** Highly resistant to atmospheric agents

## Perfekt für den Balkon, rostbeständig!

**Standort** Außen  
**Leinenlänge** 10 m  
**Merkmale** Hohe Beständigkeit gegenüber Witterungseinflüssen

## Parfait pour le balcon, absolument résistant contre la rouille!

**Où** A l'extérieur  
**Combien** 10 m  
**Pourquoi** Résistance extraordinaire aux agents atmosphériques

## ¡Perfecto para el balcón, resiste eficazmente al óxido!

**Dónde** Para exteriores  
**Cuánto** 10 m  
**Porqué** Excepcional resistencia a la intemperie



BREVETTATO  
PATENTED



# Brezza 100

**Categoria** Acciaio trattato con polveri epossidiche  
**Quanto** 10 m  
**Perché** Comodo ed elegante, con angolari di protezione e bracci in plastica facilmente regolabili ed estremamente robusti

**Material** Stahl, epoxidpulverbeschichtet  
**Leinenlänge** 10 m  
**Merkmale** Bequem und elegant, mit Schutzecken und Kunststoffarmen, einfach zu regulieren und extrem robust

**Matière** Acier traité par des poudres époxy  
**Combien** 10 m  
**Pourquoi** Confortable et élégant, pourvu de cornières de protection et de bras en plastique qui sont très robustes et peuvent être réglés aisément

**Categoría** Acero tratado con polvos epoxídicos  
**Cuánto** 10 m  
**Porqué** Cómodo y elegante, con angulares de protección y brazos de plástico fácilmente regulables y extremadamente robustos

**Category** Steel treated with epoxy powders  
**What size** 10 m  
**Why** Practical and elegant, with protective corners and a plastic arm that can easily be adjusted. Both extremely strong

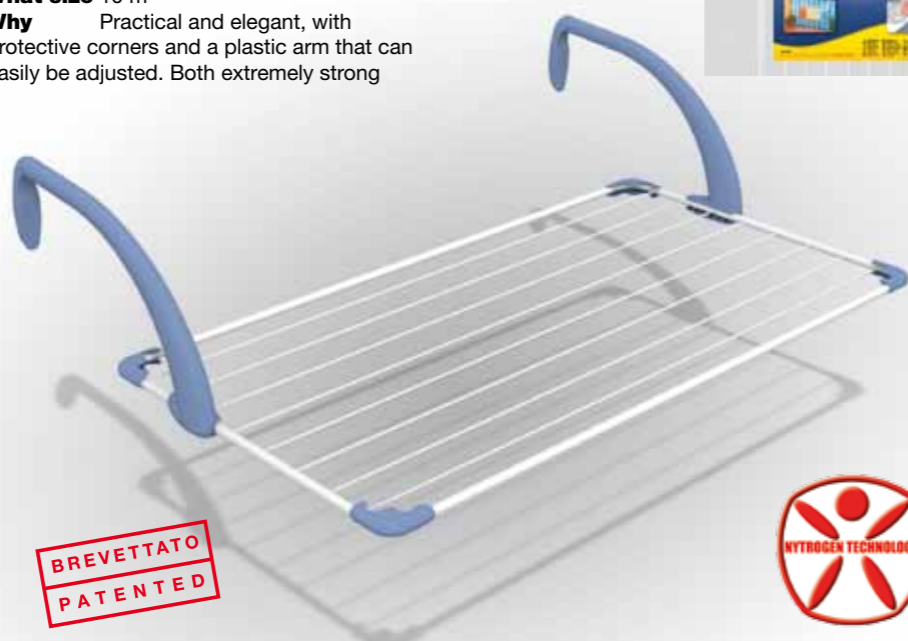

BREVETTATO  
PATENTED



# Brezza 200

**Categoria** Acciaio trattato con polveri epossidiche  
**Dove** Per esterni  
**Perché** Grazie alle ali esterne, stende fino a 18 m

**Material** Stahl, epoxidpulverbeschichtet  
**Standort** Für Aussen  
**Merkmale** Dank seiner externen Flügel mit einer Leinenlänge bis zu 18 m

**Categoría** Acero tratado con polvos epoxídicos  
**Dónde** Para exteriores  
**Porqué** Gracias a sus alas externas permite tender hasta 18 m

**Category** Steel treated with epoxy powders  
**Where** Outdoors  
**Why** Thanks to the external wings, it extends to up to 18 m

**Matière** Acier traité par des poudres époxy  
**Où** A l'extérieur  
**Pourquoi** Grâce aux ailes externes, il permet d'étendre jusqu'à 18 m de linge

BREVETTATO  
PATENTED

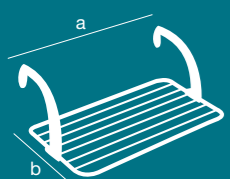

Item	Gimi	Ean	m	1 pz	kg	Aperto Open		Chiuso Folded		n° pz	n° pz	h=cm	n° pz
						axbxc=cm	axbxc=cm	axbxc=cm	axbxc=cm				
Brezza 60	10760460	8001244060067	5	1,15	8	69x53,5x27,5	53,5x4x66	67,5x17,5x55	6	84	125	92	
Brezza 100	10760540	8001244100664	10	1,60	10	109,5x55,5x27,5	55,5x4x107	56,5x19,5x110	6	48	125	49	

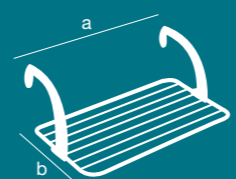

Item	Gimi	Ean	m	1 pz	kg	Aperto Open		Chiuso Folded		n° pz	n° pz	h=cm	n° pz
						axbxc=cm	axbxc=cm	axbxc=cm	axbxc=cm				
Brezza 100 Inox	10760650	8001244067059	10	1,60	10	109,5x55,5x27,5	55,5x4x107	56,5x19,5x110	6	48	125	49	
Brezza 100 Alu	10760606	8001244006645	10	1,10	10	110x55,5x30	55,5x5x108	57x20,5x110	6	48	125	46	
Brezza 200	10760620	8001244072008	18	2,15	15	178x55x27,5	55x5x107	56,5x19,5x110	6	48	125	49	

# Ghibli

## La soluzione migliore per ogni balcone!

**Categoria** 100% resina  
**Dove** Per esterni  
**Quanto** 10 m  
**Perché** Agganci scorrevoli in profondità per adattarlo ad ogni tipo di balcone; fatto per durare per sempre inalterato grazie all'innovativa tecnologia di co-iniezione di azoto

## The best solution for any balcony!

**Category** 100% resin  
**Where** Outdoors  
**What size** 10 m  
**Why** Hooks that can be slid in depth, so it can be adapted to any balcony; made to last thanks to the innovative nitrogen co-injection technology



## Die beste Lösung für jeden Balkon!

**Material** 100% Harz  
**Standort** Außen  
**Leinenlänge** 10 m  
**Merkmale** Halterungen Verstellbarkeit in der Tiefe und somit für jede Form des Balkons passend; hergestellt zwecks dauerhafter Widerstandsfähigkeit dank der innovativen Technologie der Koinjektion von Stickstoff

## La solution idéale pour chaque balcon!

**Matière** 100% résine  
**Où** A l'extérieur  
**Combien** 10 m  
**Pourquoi** Crochets qui glissent en profondeur, pour l'adapter à tout type de balcon. Il est conçu pour résister inchangé, grâce à la technologie à l'avant-garde qui utilise l'injection d'azote

## ¡La mejor solución para todo tipo de balcón!

**Categoría** 100% resina  
**Dónde** Para exteriores  
**Cuánto** 10 m  
**Porqué** Ganchos deslizables en profundidad para adaptarlo a todo tipo de balcón; realizado para durar inalterado gracias a la innovadora tecnología de co-inyección de nitrógeno

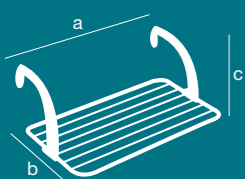

Item	Gimi	Ean	m	1 pz	kg	axbxc=cm	axbxc=cm	axbxc=cm	n° pz	n° pz	h=cm	n° pz
Ghibli	10300000	8001244885004	10	2,05	15	99x54x26	54x6x99	29x55x102	6	36	117	36

# Virgola

## Il design si fa vedere

**Categoria** 100% resina  
**Dove** Sul poggiolo  
**Quanto** 10 m  
**Perché** I bracci sono robusti oltre che eleganti e regolabili per adattarsi allo spessore del parapetto

## A masterpiece of design

**Category** 100% resin  
**Where** Balconies  
**What size** 10 m  
**Why** Provided with smart, stout, adjustable arms to fit the thickness of any balustrade or rail

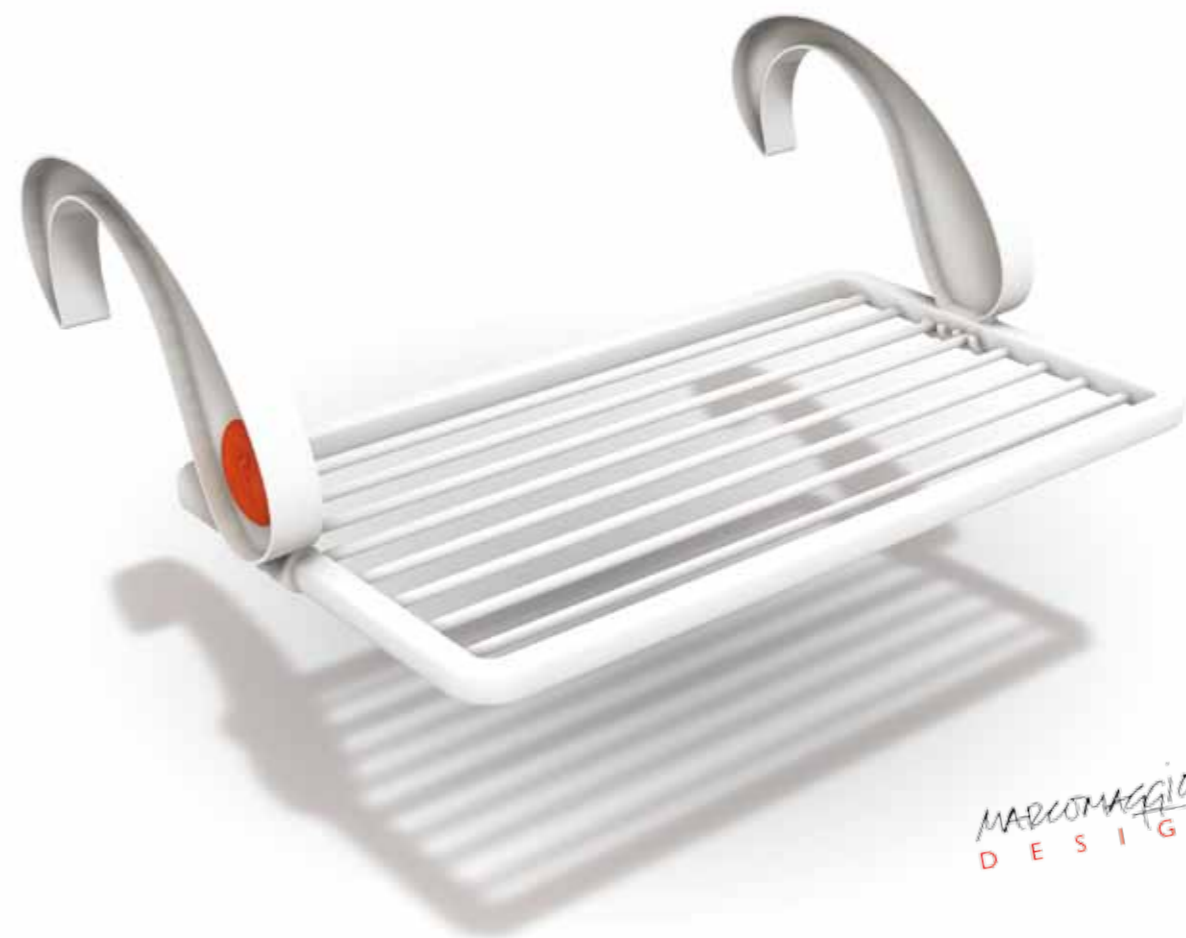

## Ansehnliches Design

**Material** 100% Harz  
**Standort** Auf dem Balkon  
**Leinenlänge** 10 m  
**Merkmale** Robuste, elegante sowie verstellbare Halterungen zur optimalen Befestigung am Geländer

## Un chef-d'oeuvre de conception

**Matière** 100% résine  
**Où** Balcons  
**Combien** 10 m  
**Pourquoi** Les bras robustes, élégants et réglables s'adaptent à l'épaisseur de toute allège ou balustrade

## El diseño se ve

**Categoría** 100% resina  
**Dónde** En el balcón  
**Cuánto** 10 m  
**Porqué** Los brazos son sólidos además de elegantes y ajustables al espesor del parapeto

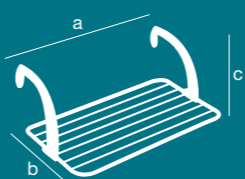

Item	Gimi	Ean	m	1 pz	kg	axbxc=cm	axbxc=cm	axbxc=cm	n° pz	n° pz	h=cm	n° pz
Virgola	10860690	8001244007321	10	1,30	5	96x50x30	50x5x96	51x24,5x96	6	42	111	50

# Ring

## Nuova soluzione per stendere all'interno e all'esterno del poggiatesta

**Categoria** Acciaio zincato  
**Dove** Per esterni  
**Quanto** Adattabile a qualsiasi misura (filo fornito 20 m)  
**Perché** Grazie al particolare fissaggio è molto stabile e poco visibile; la zincatura ne aumenta la resistenza alla corrosione ed è facilmente richiudibile

## A new solution for hanging washing on the balcony, both internally and externally

**Categoria** Zincplated steel  
**Where** For balconies  
**What size** Can be adapted to any size (20 m line supplied)  
**Why** Thanks to the special fixing, it is very stable and almost invisible; the zinc coating increases the resistance to corrosion and it can easily be closed again



## Eine neue Möglichkeit zum Wäscheaufhängen innerhalb oder außerhalb des Balkons

**Material** Stahl verzinkt  
**Standort** Außen  
**Leinenlänge** Anpassungsfähig an alle Bedürfnisse (ausgestattet mit einer Leinenlänge von 20 m)  
**Merkmale** Dank der speziellen Fixierung sehr stabil, sehr unauffällig und leicht zusammenklappbar; die Verzinkung erhöht den Korrosionsschutz

## Nouvelle solution pour étendre le linge à l'intérieur ou à l'extérieur du balcon

**Catégorie** Acier galvanisé et chromé  
**Où** Pour balcons  
**Combien** Adaptable à toutes mesures (fil fourni 20 m)  
**Pourquoi** Grâce à sa fixation spéciale, il est très stable et peu visible. La galvanisation permet d'augmenter sa résistance à la corrosion et il peut être aisément replié

## Nueva solución para tender en el interior y exterior del balcón

**Categoría** Acero galvanizado cromado  
**Dónde** Para exteriores  
**Cuánto** Puede adaptarse a cualquier medida (equipado con hilo de 20 m)  
**Porqué** Gracias a su particular fijación es muy estable y poco visible; el galvanizado aumenta la resistencia a la corrosión, se puede cerrar fácilmente

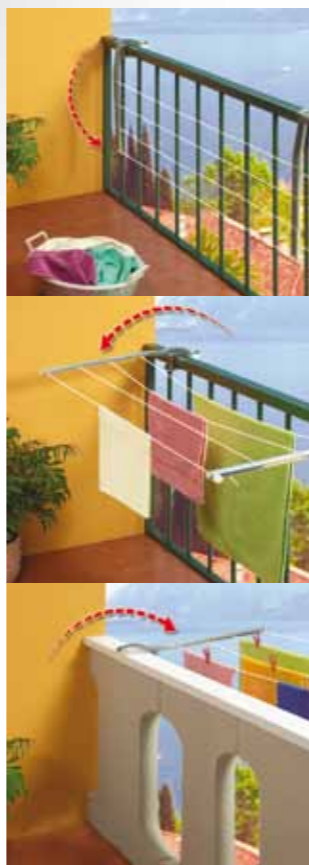

BREVETTATO  
 PATENTED

# Alablock

## Lo specialista delle vasche da bagno!

**Categoria** Acciaio verniciato  
**Dove** Per vasche da bagno  
**Quanto** 10 m  
**Perché** Piegato o steso, è l'ideale per stendere sopra la vasca da bagno grazie alla stabilità garantita dallo speciale piede di appoggio sul bordo: può essere usato in piano o ad angolo regolabile

## Especially for baths!

**Category** Painted steel  
**Where** For baths  
**What size** 10 m  
**Why** Folded or extended, it is ideal for drying washing over the bath, thanks to the stability guaranteed by the special feet that rest on the edge of the bath: it can be used flat, or at an adjustable angle

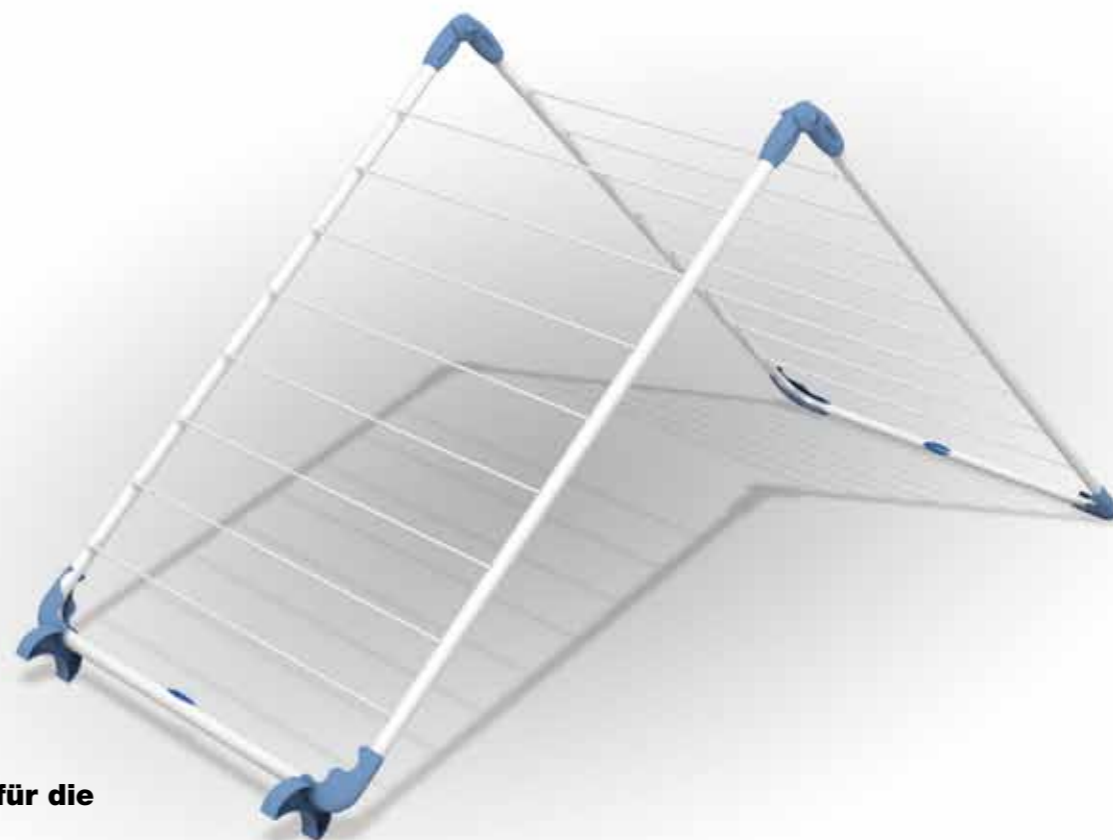

## Der Spezialist für die Badewanne!

**Material** Stahl, lackiert  
**Standort** Badewannen  
**Leinenlänge** 10 m  
**Merkmale** Zusammengeklappt oder ausgefahren ist er ideal zur Anwendung über der Badewanne. Garantierte Stabilität dank der speziellen Standfüße auf dem Wannenrand: kann flach oder mit einstellbarem Winkel benutzt werden

## Le spécialiste des baignoires!

**Catégorie** Acier peint  
**Où** Pour les baignoires  
**Combien** 10 m  
**Pourquoi** Replié ou étiré, il s'agit de la solution idéale pour étendre le linge au-dessus de la baignoire grâce à la stabilité obtenue par le pied spécial d'appui sur le bord. Il peut être utilisé horizontalement ou selon un angle réglable

## ¡El especialista de las bañeras!

**Categoría** Acero pintado  
**Dónde** Para bañeras  
**Cuánto** 10 m  
**Porqué** Plegado o extendido es ideal para tender ropa sobre la bañera gracias a la estabilidad garantizada por el pie de apoyo especial en el borde: puede usarse en horizontal o en ángulo regulable

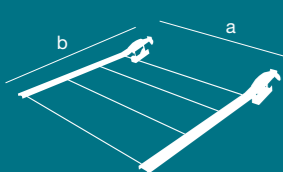

Item	Gimi	Ean	m	1 pz	kg	axb=cm	axbxc=cm	axbxc=cm	n° pz	n° pz	h=cm	n° pz
Ring	10704350	8001244005624	20	2,05	30	500x60	10x6x61	20x20,5x64	6	144	79	228

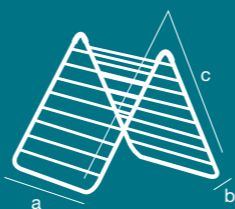

Item	Gimi	Ean	m	1 pz	kg	axbxc=cm	axbxc=cm	axbxc=cm	n° pz	n° pz	h=cm	n° pz
Alablock	10020105	8001244100602	10	1,50	10	67x8x141	67x5,5x71	69x24,5x73	5	50	161	40



# Pallino

## Arreda, stende e umidifica!

**Categoria** Aste in alluminio anodizzato

**Dove** Per interni

**Quanto** 2 m

**Perché** Tre in uno: ha la vaschetta per umidificare quando è agganciato al termosifone, si può fissare al muro come portasciugamani, o appoggiare alla vasca; e le aste possono essere ripiegate!

## Decorate, dry, and humidify!

**Category** Anodised aluminium arms

**Where** Indoors

**What size** 2 m

**Why** Three in one: it has a tank for humidifying the air when it is hooked onto the radiator; you can fix it to the wall and use it as a towel rack, or place it on the bath; and the arms can be folded away!

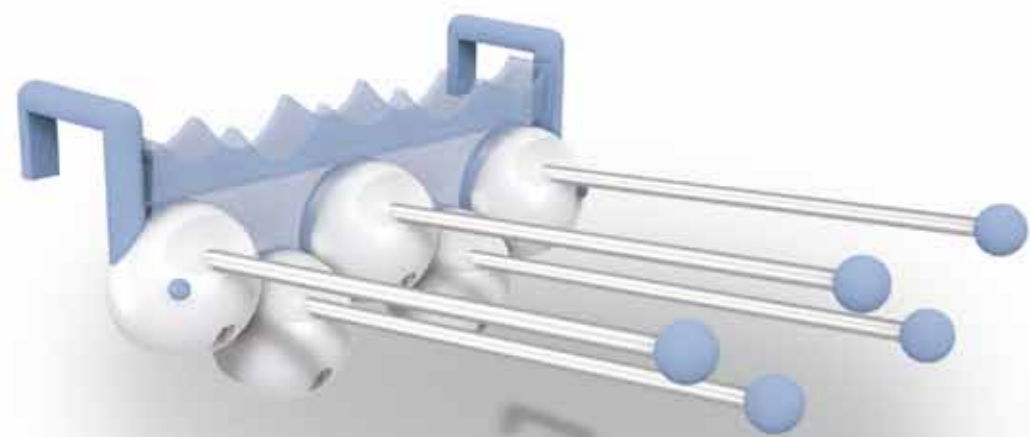

## Einrichtungsgegenstand, Wäschetrockner und Befeuchter!

**Material** Stangen aus eloxiertem Aluminium

**Standort** Innenräume

**Leinenlänge** 2 m

**Merkmale** Drei in einem: Mit einem Befeuchtungbehälter bei Anbringung an einem Heizkörper, kann an der Wand als Handtuchhalter oder an der Wanne angebracht werden; die Stangen sind einklappbar!

## Pour meubler, décorer, étendre et humidifier!

**Matière** Tiges en aluminium anodisé

**Où** A l'intérieur

**Combien** 2 m

**Pourquoi** Trois-en-un : il est pourvu d'un bac pour humidifier la pièce lorsqu'il est accroché au radiateur ; il peut être fixé au mur en tant que porte-serviettes ou directement sur la baignoire. De plus, il est possible de replier les barres!

## ¡Decora, tiende y humidifica!

**Categoría** Varillas de aluminio galvanizado

**Dónde** Para interiores

**Cuánto** 2 m

**Porqué** Tres en uno: incluye una cubeta para humidificar cuando está enganchado en el radiador, puede fijarse a la pared como toallero o apoyarse en la bañera; ¡con varillas plegables!



# Lampo

**Perché** Il più stretto: con una profondità di soli 30 cm, riduce al minimo l'ingombro sul termosifone

**Merkmale** Der Kleinste mit einer Breite von nur 30 cm reduziert den am Heizkörper erforderlichen Platz auf ein Minimum

**Porqué** El más estrecho: con una anchura de sólo 30 cm, reduce al mínimo el espacio ocupado en el radiador

**Why** The narrowest: just 30 cm wide, this reduces the space occupied on the radiator to a minimum

**Pourquoi** Le plus étroit: sa longueur de 30 cm seulement réduit au minimum l'encombrement sur le radiateur

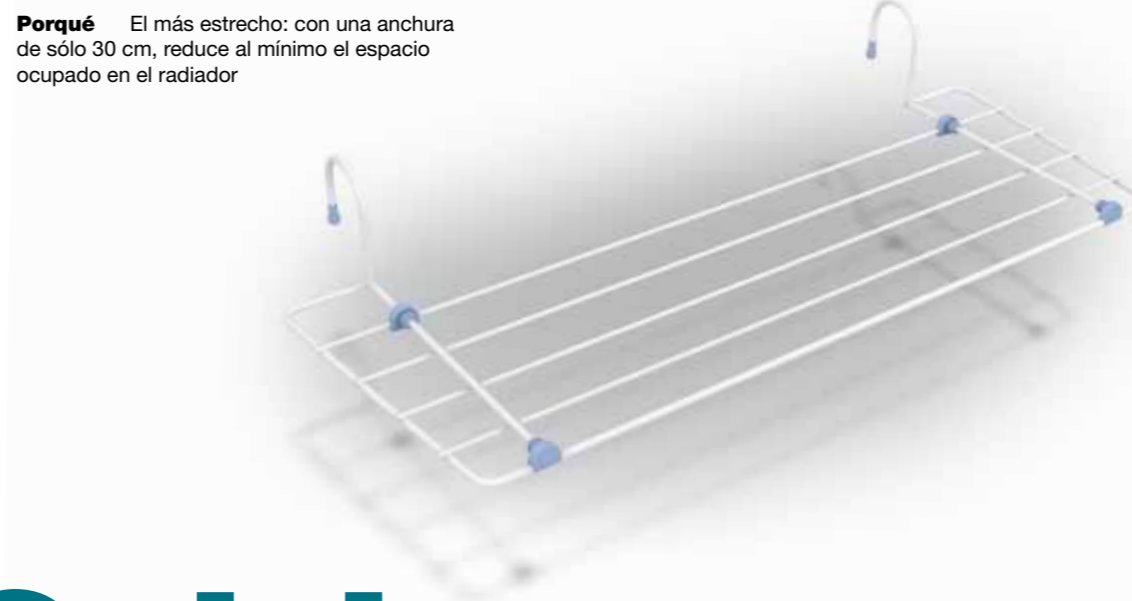

# Quick

**Perché** La soluzione da termosifone con agganci resistenti e regolabili

**Merkmale** Ausführung für Heizkörper mit widerstandsfähigen und einstellbaren Halterungen

**Porqué** La solución para radiador con enganches resistentes y regulables

**Why** The solution for radiators with resistant and adjustable hooks

**Pourquoi** La solution pour les radiateurs pourvue de crochets résistants et réglables

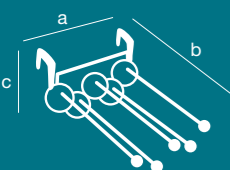
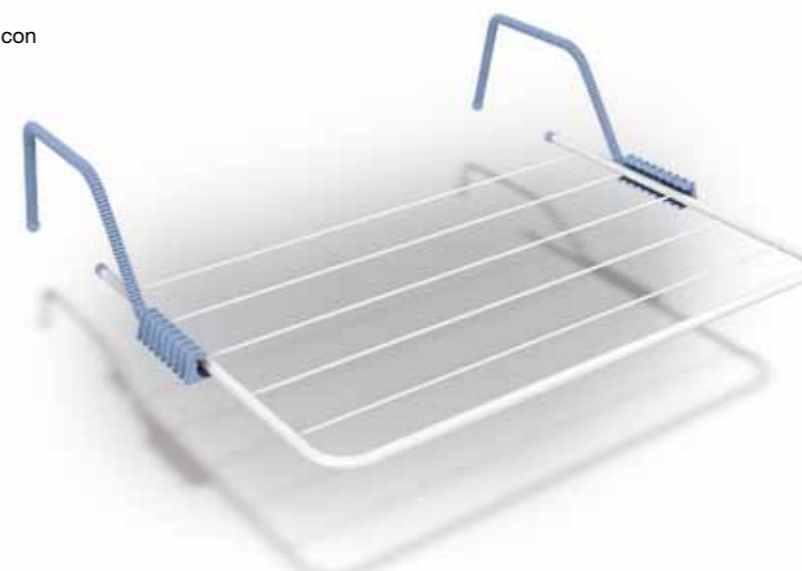

Item	Gimi	Ean	m	1 pz	kg	axbxc=cm	axbxc=cm	axbxc=cm	n° pz	n° pz	h=cm	n° pz
Pallino	10760350	8001244004344	2	0,75	3	35x53x21	35x6,5x50,5	36x40x47	10	120	109	147



Item	Gimi	Ean	m	1 pz	kg	axbxc=cm	axbxc=cm	axbxc=cm	n° pz	n° pz	h=cm	n° pz
Lampo	10445000	8001244107052	2,5	0,35	3	52x30,5x17	30,5x2x52	34x32x58	36	864	189	570
Quick	10660010	8001244107007	3	0,5	5	52x33x14	33x3x52	36x30x54	15	360	177	257

# Airy

## L'ideale per il termosifone!

**Categoria** Griglia in acciaio verniciato e bracci in resina estremamente robusti e di facile regolazione

**Dove** Per termosifoni

**Quanto** 3 m

**Perché** Permette di stendere il bucato sul termosifone: perfetto in inverno e poco ingombrante una volta chiuso

## Ideal for the radiator!

**Category** Painted steel rack and resin arms, both extremely strong and easy to adjust

**Where** For radiators

**What size** 3 m

**Why** Lets you dry washing on the radiator: perfect in winter, it takes up very little room when closed



# Pliko

## Lo metti, lo togli e lo sposti in un secondo.

**Categoria** 100% resina

**Dove** Per termosifoni, vasche e balconi

**Quanto** 3,5 m

**Perché** Grazie agli agganci estraibili è super compatto e semplicissimo da posizionare ovunque, anche su vasche tonde

## Put it up, take it down, and move it in the blink of an eye.

**Category** 100% resin

**Where** For radiators, baths and balconies

**What size** 3,5 m

**Why** Thanks to its pull-out hooks, it is very compact and extremely simple to position everywhere, even on round baths

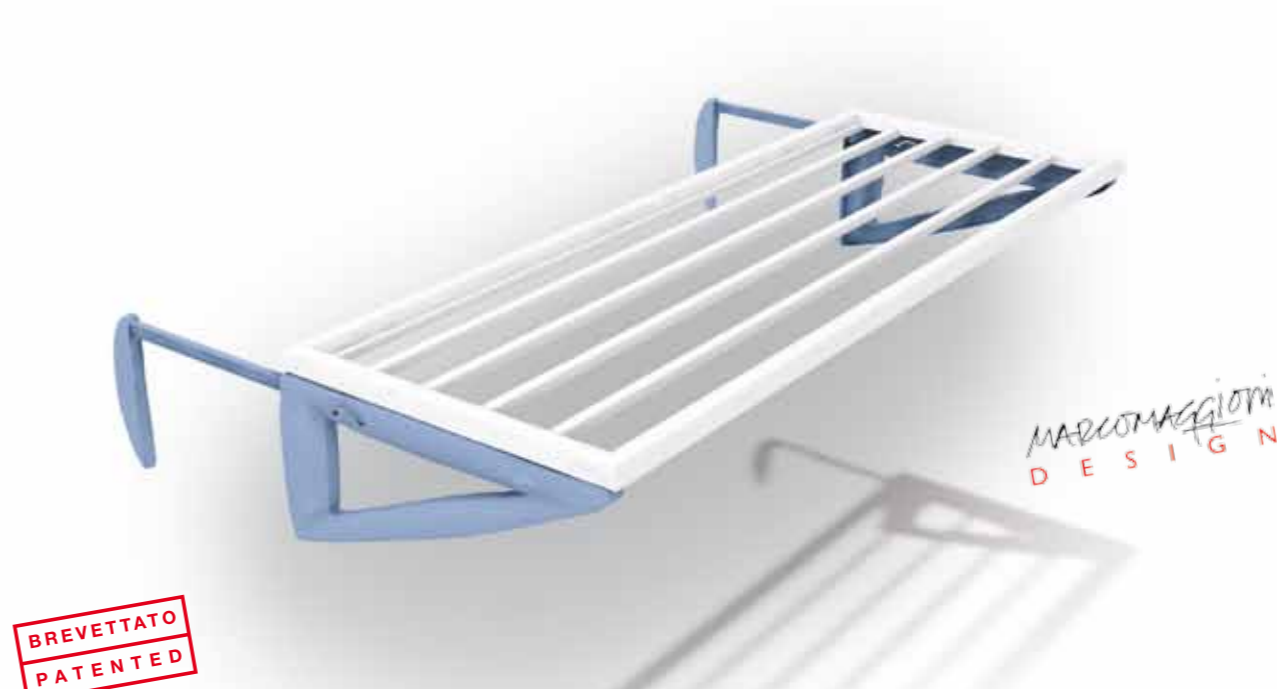
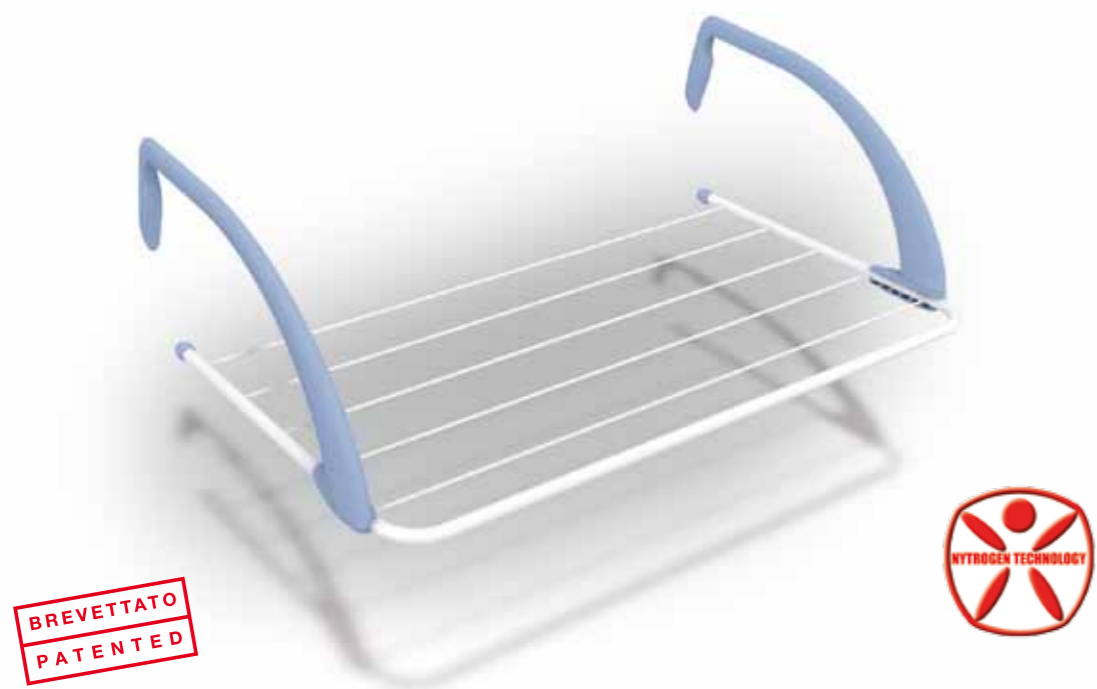

## Ideal für Heizkörper!

**Material** Gitter in lackiertem Stahl mit extrem robusten, einfach regulierbaren Kunstharz-Armen versehen

**Standort** Heizkörper

**Leinenlänge** 3 m

**Merkmale** Ermöglicht das Aufhängen von Kleidungsstücken über dem Heizkörper, eignet sich perfekt für den Winter, im geschlossenen Zustand sehr Platz sparend

## La solution idéale pour les radiateurs!

**Catégorie** Grille en acier peint et bras en résine très robustes et aisément réglables

**Où** Pour les radiateurs

**Combien** 3 m

**Pourquoi** Pour étendre le linge sur le radiateur. Il est idéal pendant l'hiver et il est peu encombrant lorsqu'il est replié

## ¡Ideal para el termosifón!

**Categoría** Rejilla de acero pintado y brazos de resina extremadamente robustos y fácilmente regulables

**Dónde** Para radiadores

**Cuánto** 3 m

**Porqué** Permite tender la ropa lavada en el radiador: perfecto en invierno, una vez cerrado ocupa muy poco espacio



## Sekundenschnell auf-, abmontiert und umgestellt.

**Material** 100% Harz

**Standort** Heizkörper, Wannen und Balkone

**Leinenlänge** 3,5 m

**Merkmale** Durch die ausziehbaren Halterungen ist er superkompakt und sehr einfach an jedem Ort aufzustellen, sogar auf runden Wannen

## Vous le positionnez, l'enlevez et le déplacez en un clin d'oeil!

**Matière** 100% résine

**Où** Pour les radiateurs, les baignoires et les balcons

**Combien** 3,5 m

**Pourquoi** Grâce aux crochets amovibles, il est extrêmement compact et très simple à positionner, partout, même sur des baignoires rondes

## ¡Lo pones, lo quitas y lo desplazas en un segundo!

**Categoría** 100% resina

**Dónde** Para radiadores, bañeras y balcones

**Cuánto** 3,5 m

**Porqué** Gracias a sus ganchos extraíbles es súper compacto y sencillísimo de colocar en cualquier lugar, incluso en bañeras redondas

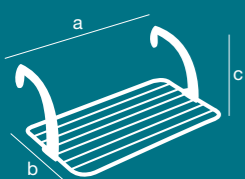

Item	Gimi	Ean	m	1 pz	kg	axbxc=cm	axbxc=cm	axbxc=cm	n° pz	n° pz	h=cm	n° pz
Airy	10190900	8001244001879	3	0,45	5	52x34,5x18	34,5x2x52	35,5x28,5x54	15	360	177	274

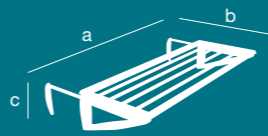

Item	Gimi	Ean	m	1 pz	kg	axbxc=cm	axbxc=cm	axbxc=cm	n° pz	n° pz	h=cm	n° pz
Pliko	10620058	8001244062009	3,5	0,4	5	55,5x28,5x13	28,5x4x55,5	79,5x30,5x57	20	160	129	144

# Stendibiancheria da parete e soffitto

# Rotor 1



## La scelta perfetta per i piccoli ambienti

**Categoria** 100% resina  
**Dove** Per pareti interne ed esterne  
**Quanto** 3 m  
**Perché** Solo due eleganti bottoni di plastica, pratico ed indistruttibile

## The perfect choice for small environments

**Category** 100% resin  
**Where** For internal and external walls  
**What size** 3 m  
**Why** Just two elegant plastic buttons, practical and indestructible

Parete Wall						
Materiale Material	👕👖👗	Nome prodotto Item	Plus			
			Esclusiva Gimi Gimi exclusive	A soffietto Accordion opening	Telescopico Telescopic	Altro Other
Resina Resin	m 3	Rotor 1				appendice porta asciugamani multipurpose hanging hook
	m 14	Rotor 4				appendice porta asciugamani multipurpose hanging hook nuovo sistema di bloccaggio new blocking system
	m 21	Rotor 6				appendice porta asciugamani multipurpose hanging hook nuovo sistema di bloccaggio new blocking system
Acciaio Steel	m 3	Brio Super 60		✓		
	m 4	Brio Super 80		✓		
	m 5	Brio Super 100		✓		
	m 6	Brio Super 120		✓		
Alluminio / resina Aluminium / resin	m 4	Skatto 70		✓		alluminio anodizzato anodised aluminium
	m 6	Skatto 100		✓		alluminio anodizzato anodised aluminium
	m 3,5	Telepack 50	✓		✓	portasciugamani towel rack
	m 5	Telepack 70	✓		✓	portasciugamani towel rack
	m 7	Telepack 100	✓		✓	portasciugamani towel rack

Parete/Soffitto Wall/Ceiling					
Materiale Material	👕👖👗	Nome prodotto Item	Plus		
			Rivestimenti particolari Special coverings	Estensibile Extensible	Altro Other
Acciaio / resina Steel / resin	m 6	Lift 100	✓		
	m 7	Lift 120	✓		
	m 8,5	Lift 140	✓		
	m 9,5	Lift 160	✓		
Alluminio / resina Aluminium / resin	m 10	Unix		✓	portata 20 kg loading capacity 20 kg

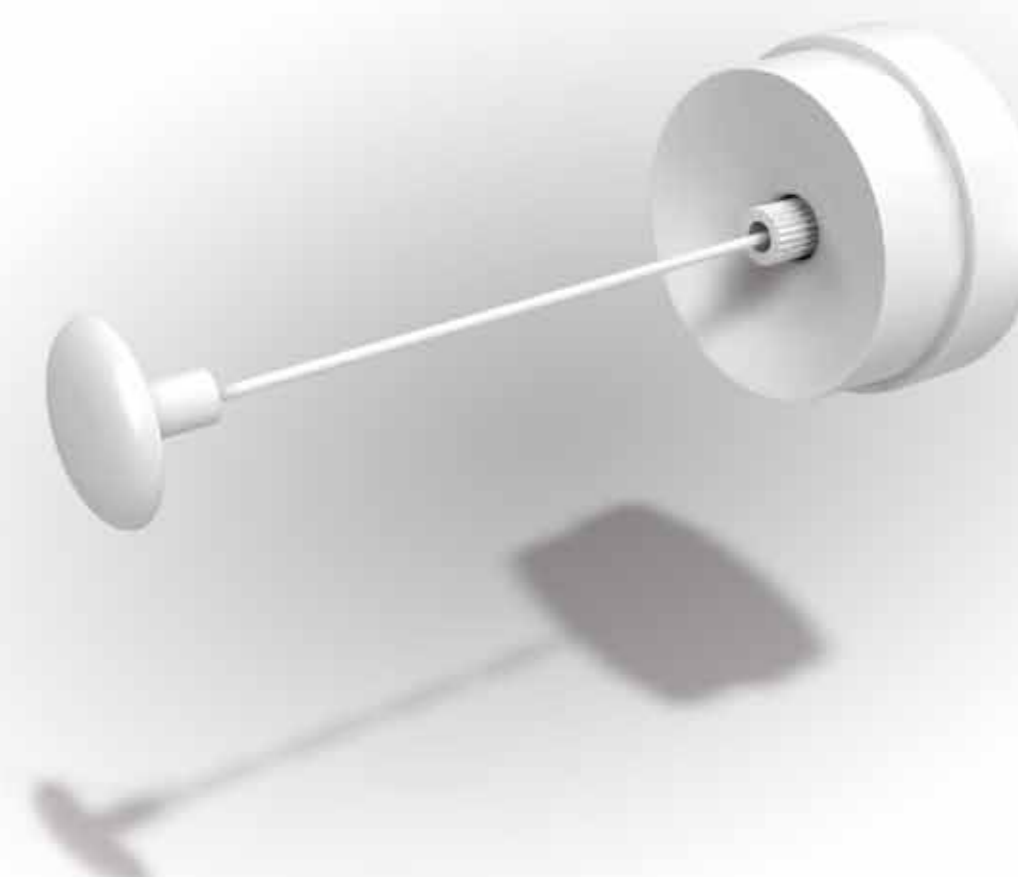

## Die perfekte Lösung für kleine Räume

**Material** 100% Harz  
**Standort** Innen- und Außenwände  
**Leinenlänge** 3 m  
**Merkmale** Mit nur zwei eleganten Plastikbuttons, praktisch und extrem beständig

## Le choix idéal pour les petites pièces

**Matière** 100% résine  
**Où** Pour les parois à l'intérieur et à l'extérieur  
**Combien** 3 m  
**Pourquoi** Exclusivement deux élégants boutons en plastique, pratique et indestructible

## La perfecta elección para los ambientes pequeños

**Categoría** 100% resina  
**Dónde** Para paredes externas e internas  
**Cuánto** 3 m  
**Porqué** Sólo dos elegantes botones de plástico, práctico e indestructible

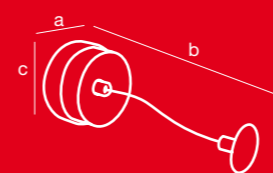

Aperto  
Open

Chiuso  
Folded



Item	Gimi	Ean	m	1 pz	kg	axbxc=cm	axbxc=cm	axbxc=cm	n° pz	n° pz	h=cm	n° pz
Rotor 1	10717001	8001244003194	3	0,33	3	10,5x300x10,5	21x7x29	34,5x30x31,5	12	384	141	368

Per descrizioni dettagliate consultare le pagine dei singoli prodotti.  
 For more details please see the related product pages.

# Rotor 4

**Categoria** 100% resina  
**Dove** Per pareti interne ed esterne  
**Quanto** 14 m  
**Perché** Tanti metri di filo per stendere senza nessun tipo di ingombro: la scelta perfetta per i piccoli ambienti, ancora migliore col nuovo sistema di bloccaggio dei fili

**Material** 100% Harz  
**Standort** Innen- und Außenwände  
**Leinenlänge** 14 m  
**Merkmale** Viele Meter Wäscheleine die nirgends im Weg ist: die perfekte Lösung für kleine Räume und heute noch praktischer dank dem neuen System der Leinenverriegelung

**Matière** 100% résine  
**Où** Pour les parois à l'intérieur et à l'extérieur  
**Combien** 14 m  
**Pourquoi** Plusieurs mètres de fil pour sécher le linge sans aucun encombrement: le choix parfait pour de petites pièces, amélioré par le nouveau système de blocage des fils

**Categoría** 100% resina  
**Dónde** Para paredes externas e internas  
**Cuánto** 14 m  
**Porqué** Muchos metros de cuerda para tender la ropa sin ocupar espacio: la solución perfecta para los ambientes pequeños, aun mejor con el nuevo sistema de bloqueo

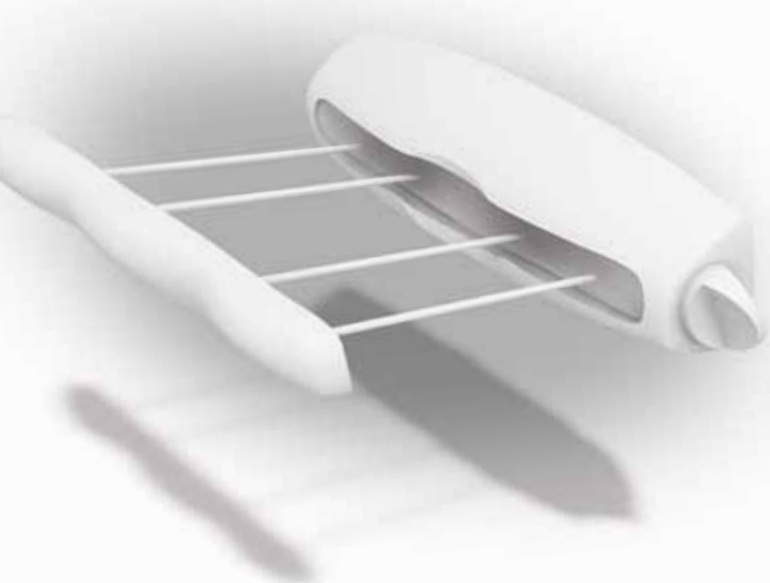

**Categoria** 100% resina  
**Dove** Per pareti interne ed esterne  
**Quanto** 21 m  
**Perché** Ancora più filo per stendere: la scelta perfetta per i piccoli ambienti, ancora migliore col nuovo sistema di bloccaggio dei fili

**Material** 100% Harz  
**Standort** Innen- und Außenwände  
**Leinenlänge** 21 m  
**Merkmale** Noch mehr Meter Wäscheleine: die perfekte Lösung für kleine Räume und heute noch praktischer dank dem neuen System der Leinenverriegelung

**Matière** 100% résine  
**Où** Pour les parois à l'intérieur et à l'extérieur  
**Combien** 21 m  
**Pourquoi** Davantage de fil pour sécher le linge: le choix parfait pour de petites pièces, amélioré par le nouveau système de blocage des fils

**Categoría** 100% resina  
**Dónde** Para paredes externas e internas  
**Cuánto** 21 m  
**Porqué** Más cuerda para tender la ropa: la solución perfecta para los ambientes pequeños, aun mejor con el nuevo sistema de bloqueo

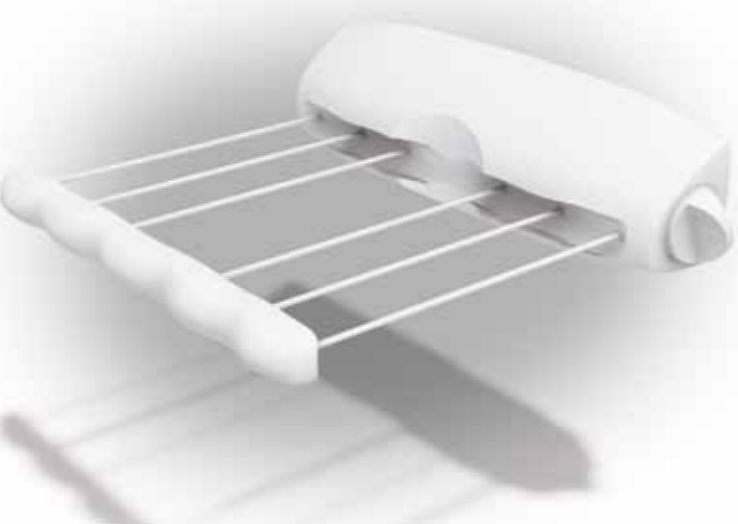

# Brio Super

**Apertura a soffietto, bucato perfetto!**

**Categoria** Acciaio trattato con polveri epossidiche  
**Dove** Per pareti esterne e interne  
**Quanto** Da 3 a 6 m  
**Perché** Tante misure per ogni esigenza; il design rialzato dei fili facilita il posizionamento dei panni

**Wall mounted easy pull-out airer for perfect drying!**

**Category** Steel treated with epoxy powders  
**Where** For external and internal walls  
**What size** From 3 m to 6 m  
**Why** Many different sizes to meet every requirement; the higher position of lines makes the clothes easier to hang out

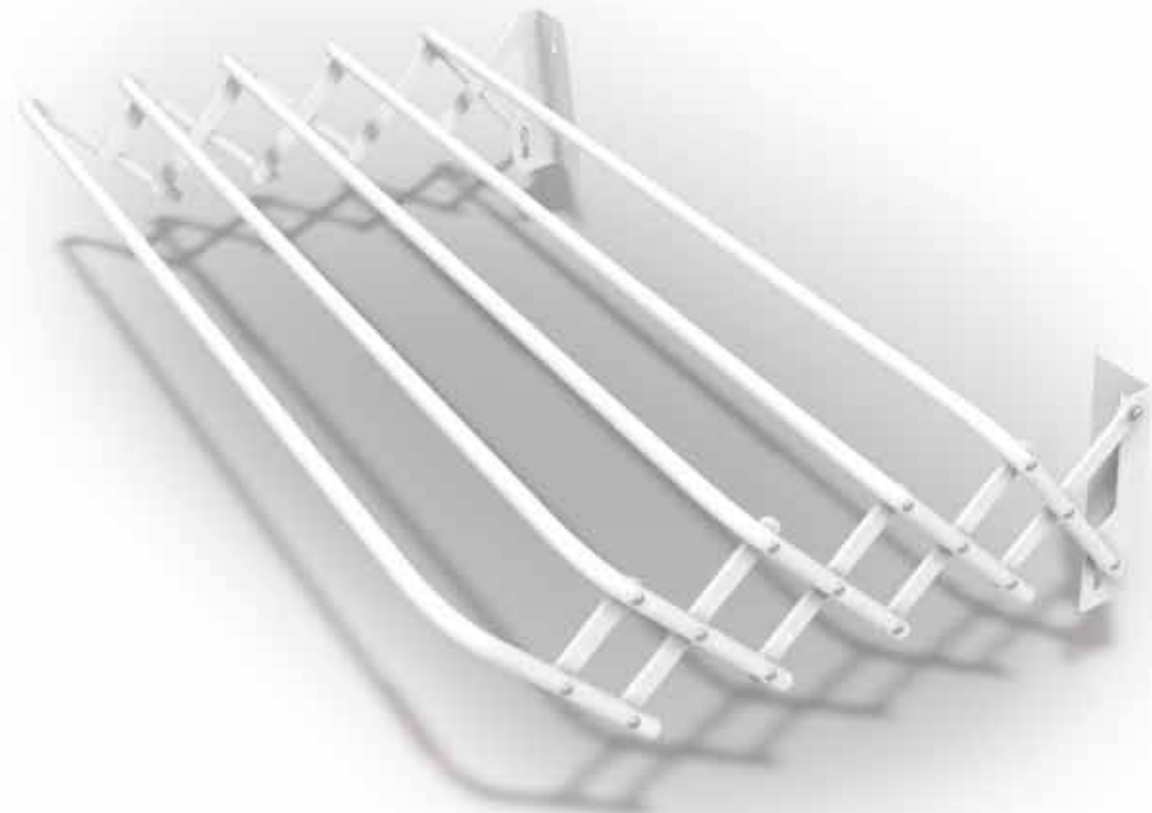

**Auffaltbare Öffnung für ein perfektes Wäscheaufhängen!**

**Material** Stahl, epoxidpulverbeschichtet  
**Standort** Außen- und Innenwände  
**Leinenlänge** Von 3 m bis 6 m  
**Merkmale** Viele Größen für jedes Bedürfnis; die Ausführung der Drähte vereinfacht das Aufhängen der Wäschestücke

**Ouverture à soufflet pour un linge parfait!**

**Catégorie** Acier traité par des poudres époxy  
**Où** Pour les parois à l'intérieur et à l'extérieur  
**Combien** 3 à 6 m  
**Pourquoi** Nombreuses dimensions. La position des fils facilite la mise en place du linge

**¡Apertura tipo fuelle, ropa lavada perfecta!**

**Categoría** Acero tratado con polvos epoxídicos  
**Dónde** Para paredes externas e internas  
**Cuánto** De 3 m a 6 m  
**Porqué** Tantas medidas para todos los requerimientos; el diseño sobreelevado de los hilos facilita la colocación de las prendas

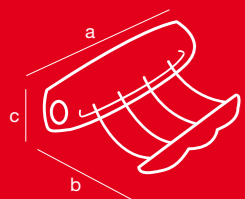

Item	Gimi	Ean	m	1 pz	kg	Aperto Open	Chiuso Folded	axbxc=cm	axbxc=cm	axbxc=cm	n° pz	n° pz	h=cm	n° pz
Rotor 4	10717005	8001244850002	14	0,5	8	30x360x8	24x10x38,5	38,5x25x59	12	324	192	211		
Rotor 6	10717065	8001244860001	21	0,7	10	40,5x360x8,5	24x10x46,5	47x25x59	12	252	192	173		

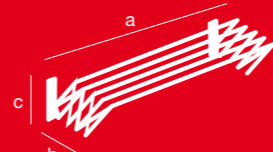

Item	Gimi	Ean	m	1 pz	kg	Aperto Open	Chiuso Folded	axbxc=cm	axbxc=cm	axbxc=cm	n° pz	n° pz	h=cm	n° pz
Brio Super 60	10070063	8001244073067	3	0,95	10	60x47x19	60x9x19	23,5x23,5x76	10	150	91	238		
Brio Super 80	10070083	8001244073081	4	1,20	10	80x47x19	80x9x19	23,5x23,5x97	10	150	112	186		
Brio Super 100	10070103	8001244073104	5	1,35	10	100x47x19	100x9x19	23,5x23,5x116	10	150	131	156		
Brio Super 120	10070123	8001244073128	6	1,45	10	120x47x19	120x9x19	23,5x23,5x136	10	150	151	133		

# Skatto

## Ripiegabile, estensibile, impeccabile!

**Category** Aste in alluminio anodizzato

**Dove** Per bagno, lavanderia, garage, terrazzo

**Quanto** Da 4 a 6 m

**Perché** Un modello sempre perfetto grazie alla bellezza unica dell'alluminio

## Foldaway, extendable, impeccable!

**Category** Anodised aluminium arms

**Where** For bathrooms, laundries, garages and terraces

**What size** From 4 to 6 m

**Why** The perfect model thanks to the unique beauty of aluminium



# Telepack

## L'unico telescopico da parete!

**Category** Aste in alluminio e struttura in resina plastica

**Come** Telescopico, fino a 6 fili

**Dove** Per pareti esterne e interne

**Quanto** Da 3,5 a 7 m

**Perché** Discreto e pratico: si fissa alla parete e si apre solo quando serve. Chiuso è un comodo portasciugamani

## The unique telescopic wall unit!

**Category** Aluminium arms and plastic resin frame

**How** Telescopic, up to 6 lines

**Where** For external and internal walls

**What size** From 3.5 to 7 m

**Why** Discrete and practical: it is fixed to a wall and can be opened only when needed. When closed, it can be used as a practical towel rack

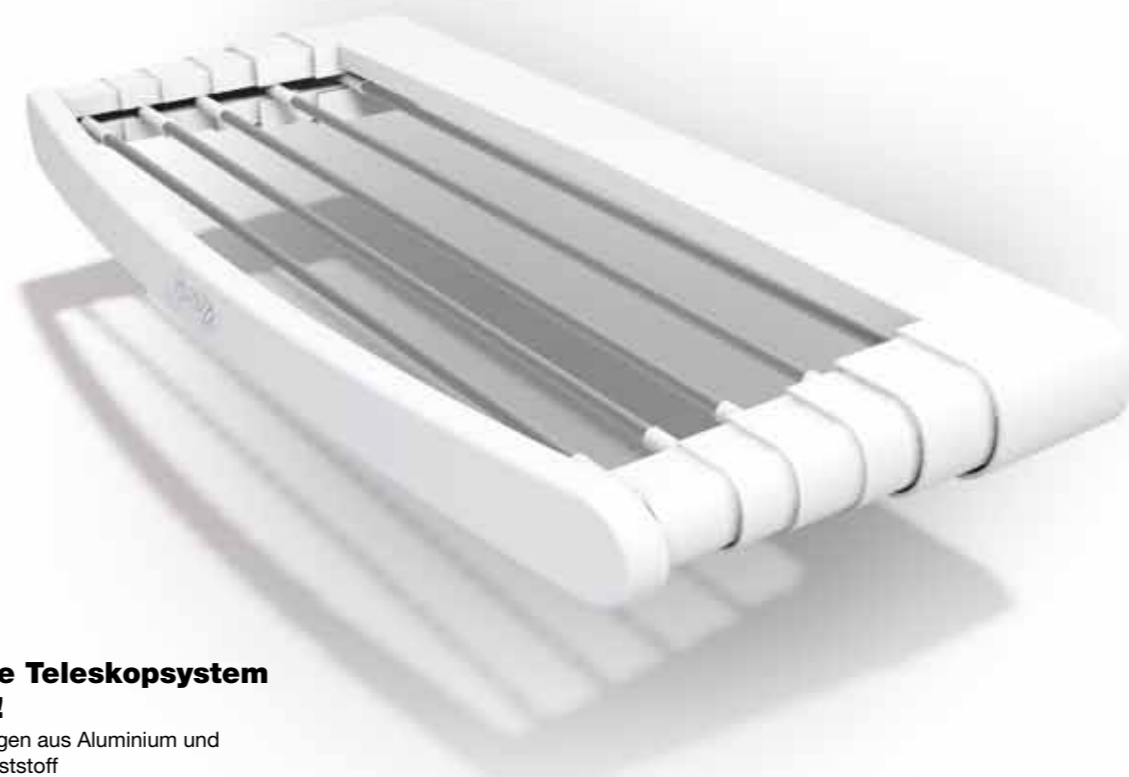
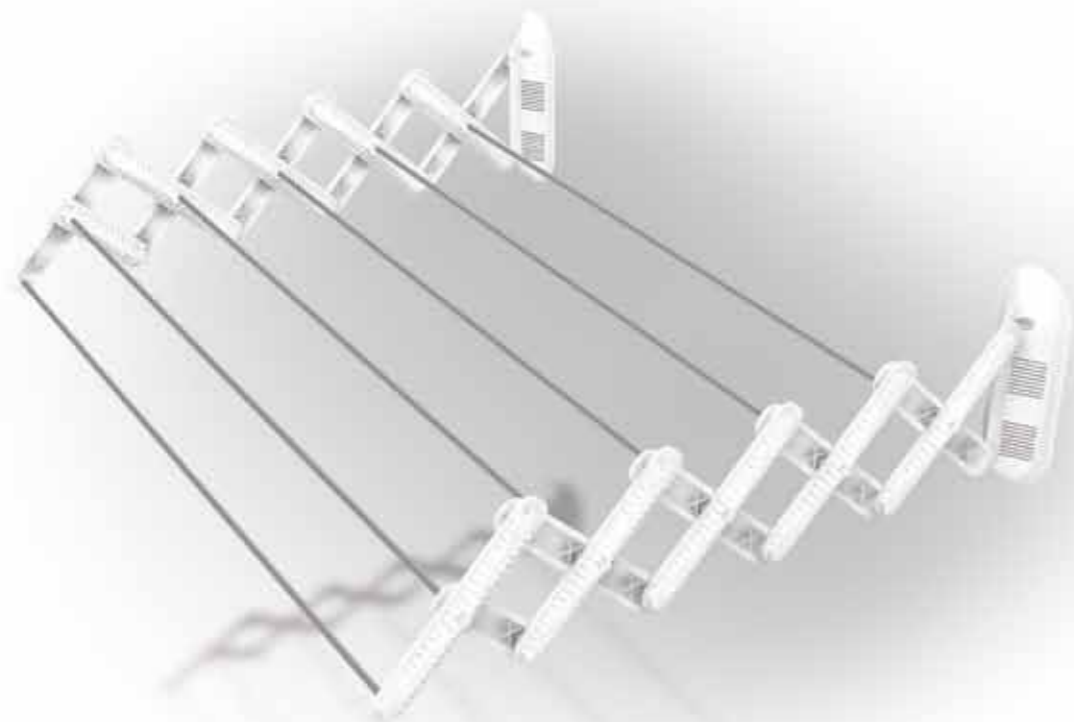

MARCOMAGGIOM  
DESIGN

## Klappbar, ausziehbar, tadellos!

**Material** Stangen aus eloxiertem Aluminium

**Standort** Bad, Waschküche, Garage, Terrasse

**Leinenlänge** Von 4 m bis 6 m

**Merkmale** Ein immer perfektes Modell durch die einmalige Schönheit der Aluminiumstruktur

## Repliable, extensible, impeccable!

**Matière** Tiges en aluminium anodisé

**Où** Pour la salle de bains, la buanderie, le garage et la terrasse

**Combien** 4 à 6 m

**Pourquoi** Un modèle toujours parfait grâce à la beauté unique de l'aluminium

## ¡Plegable, extensible y impeccable!

**Categoría** Varillas de aluminio galvanizado

**Dónde** Para baño, lavandería, garaje, terraza

**Cuánto** De 4 m a 6 m

**Porqué** Un modelo siempre perfecto gracias a la belleza única del aluminio



## Das einzige Teleskopsystem für Wände!

**Material** Stangen aus Aluminium und Struktur aus Kunststoff

**Ausstattung** Teleskopische Ausführung, bis zu 6 Drähten

**Standort** Außen- und Innenwände

**Leinenlänge** Von 3,5 m bis 7 m

**Merkmale** Schlicht und praktisch: es wird an den Wänden angebracht und nur bei Gebrauch ausgezogen. Geschlossen ist es eine praktische Handtuchhalterung

## Le seul étendoir télescopique mural!

**Matière** Barres en aluminium et structure en résine plastique

**Comment** Télescopique, jusqu'à 6 fils

**Où** Pour les parois à l'intérieur et à l'extérieur

**Combien** 3,5 à 7 m

**Pourquoi** Discret et pratique : vous le fixez au mur, puis l'ouvrez uniquement pour l'utiliser. Lorsqu'il est fermé, il devient un porte-serviettes pratique

## ¡El único telescópico de pared!

**Categoría** Varillas de aluminio y estructura de resina plástica

**Cómo** Telescópico, hasta 6 hilos

**Dónde** Para paredes externas e internas

**Cuánto** De 3,5 m a 7 m

**Porqué** Discreto y práctico; se fija a la pared y se abre sólo cuando es necesario. Cerrado se convierte en un cómodo toallero

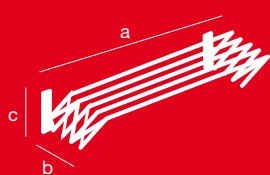

Item	Gimi	Ean	m	1 pz	kg	axbxc=cm	axbxc=cm	axbxc=cm	n° pz	n° pz	h=cm	n° pz
Skatto 70	10720080	8001244863309	4	0,65	7	74x50x16	74x17x21,5	57,5x17x78	6	96	171	78
Skatto 100	10720100	8001244863354	6	0,75	7	104x50x16	103x17x21,5	58x17x107	6	48	122	56

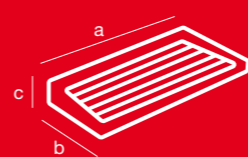

Item	Gimi	Ean	m	1 pz	kg	axbxc=cm	axbxc=cm	axbxc=cm	n° pz	n° pz	h=cm	n° pz
Telepack 50	10770050	8001244108561	3,5	0,85	7	60x39x7,5	14x7x60	24x29,5x62	6	144	139	136
Telepack 70	10770075	8001244863408	5	1,35	7	70x38x6	14,5x6,5x74,5	30x20x72,5	6	192	160	137
Telepack 100	10770105	8001244863453	7	1,7	7	100x38x6	14,5x6,5x104,5	30x20x103,5	6	96	118,5	96

# Lift

## Per sfruttare tutto lo spazio, anche quello verticale!

**Categoria** Acciaio trattato con polveri epossidiche

**Dove** Per parete e soffitto

**Quanto** Disponibile in 4 modelli da 100, 120, 140 e 160 cm

**Perché** Si fissa in alto sulla parete: tramite l'asta i fili si alzano e abbassano per poter stendere il bucato

## To get the most out of every space, even vertical space!

**Category** Steel treated with epoxy powders

**Where** For walls and ceilings

**What size** Available in 4 models: 100, 120, 140 and 160 cm

**Why** Fixed high up on the wall: the lines are raised or lowered with the rod, to hang out the washing

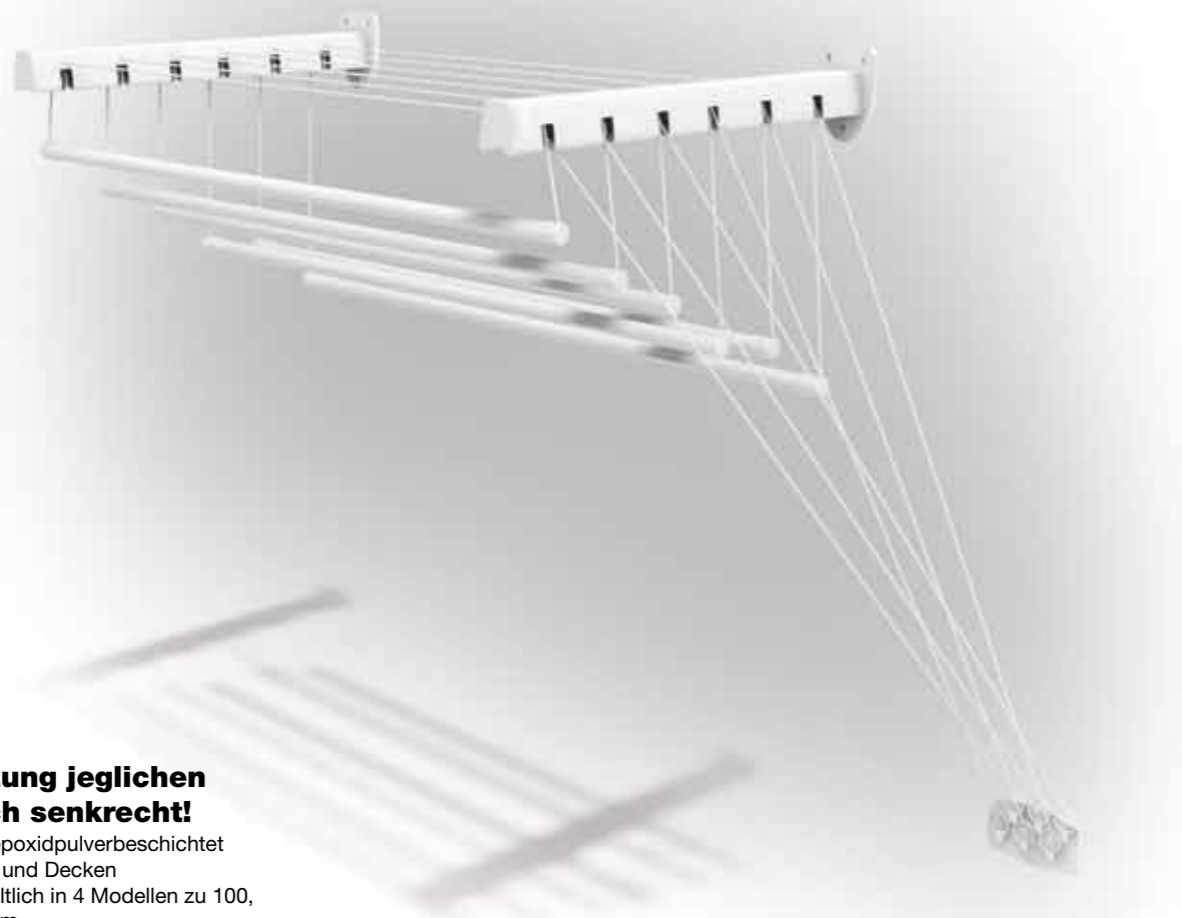

## Zur Ausnutzung jeglichen Platzes, auch senkrecht!

**Material** Stahl, epoxidpulverbeschichtet

**Standort** Wände und Decken

**Leinenlänge** Erhältlich in 4 Modellen zu 100, 120, 140 und 160 cm

**Merkmale** Befestigung oben an den Wänden: mittels einer Stange kann die Leine hoch- bzw. heruntergefahren werden, um die Wäschestücke auf- bzw. abzuhängen

## Pour profiter de tout l'espace disponible, même en hauteur!

**Matière** Acier traité par des poudres époxy

**Où** Pour les parois et le plafond

**Combien** Disponible en 4 modèles de 100, 120, 140 et 160 cm

**Pourquoi** Il peut être fixé en haut, sur la paroi. Sa barre spéciale permet de lever et de baisser les fils pour étendre le linge

## ¡Para aprovechar todo el espacio, incluso en sentido vertical!

**Categoría** Acero tratado con polvos epoxídicos

**Dónde** Para pared y techo

**Cuánto** Disponible en 4 modelos de 100, 120, 140 y 160 cm

**Porqué** Se fija en la parte alta de la pared: mediante la varilla se suben y bajan los hilos para poder tender la ropa lavada

# Unix

## In alto la comodità!

**Categoria** Aste in alluminio anodizzato

**Dove** Per parete e soffitto

**Quanto** Fino a 9,6 m

**Perché** Si fissa in alto sulla parete: tramite l'asta i fili si alzano e abbassano per poter stendere il bucato, le aste sono telescopiche da 100 fino a 160 cm

## Practicality, above anything else!

**Category** Anodised aluminium arms

**Where** For walls and ceilings

**What size** Up to 9,6 m

**Why** Fixed high up on the wall: the lines are raised or lowered with the rod, to hang out the washing. The arms are telescopic with a range from 100 to 160 cm

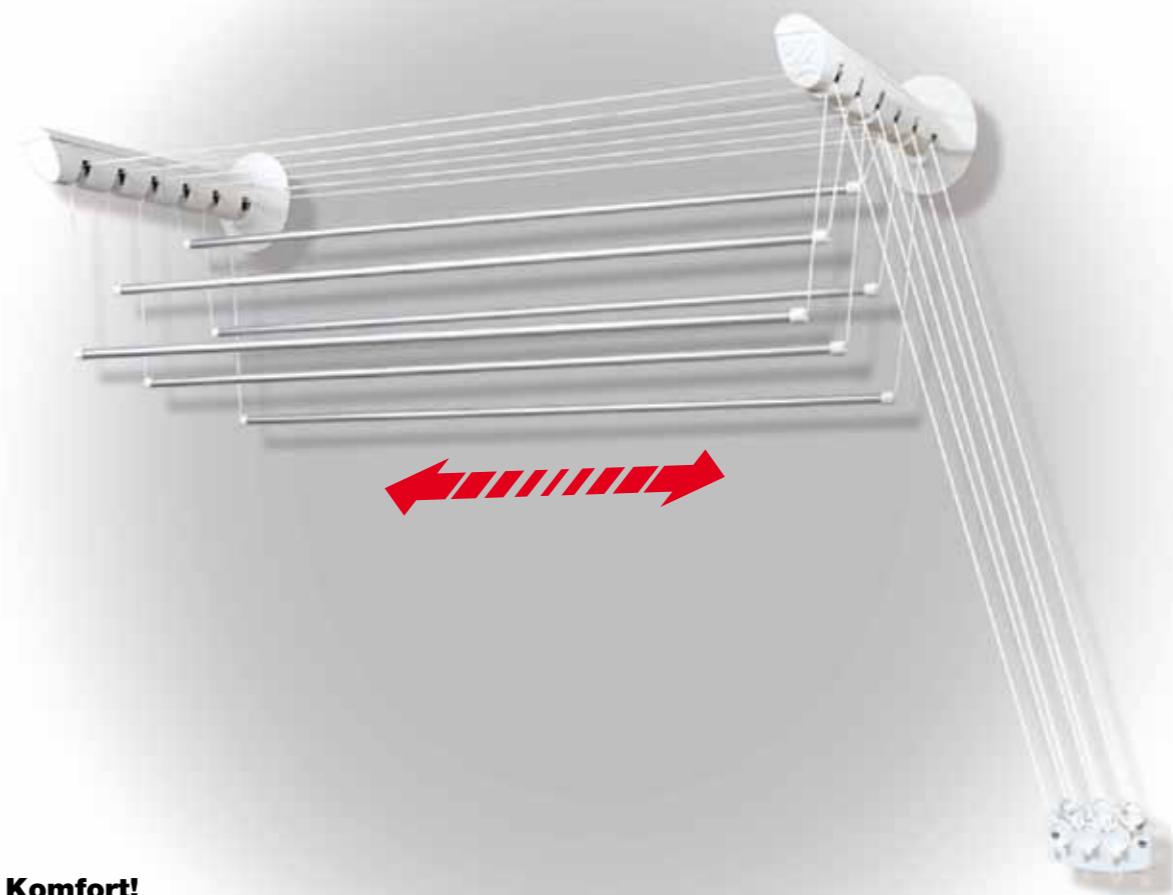

## Höchster Komfort!

**Material** Stangen aus eloxiertem Aluminium

**Standort** Wände und Decken

**Leinenlänge** Bis zu 9,6 m

**Merkmale** Befestigung an der Wand: mittels einer Stange können die Drähte hoch- bzw. heruntergenommen werden, um die Wäsche aufzuhängen bzw. abzunehmen

## Le confort en haut!

**Matière** Barres en aluminium anodisé

**Où** Pour les parois et le plafond

**Combien** Jusqu'à 9,6 m

**Pourquoi** Il peut être fixé en haut, sur la paroi. Sa barre spéciale permet de lever et de baisser les fils pour étendre le linge, les barres sont télescopiques de 100 jusqu'à 160 cm

## ¡Arriba la comodidad!

**Categoría** Varillas de aluminio galvanizado

**Dónde** Para pared y techo

**Cuánto** Hasta 9,6 m

**Porqué** Se fija en la parte alta de la pared: mediante la varilla los hilos se suben y bajan para poder tender la ropa lavada, las varillas son telescópicas de 100 hasta 160 cm

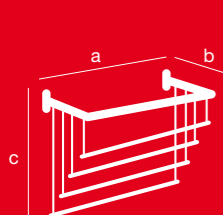

Item	Gimi	Ean	m	1 pz	kg	Aperto Open		Chiuso Folded		n° pz	n° pz	h=cm	n° pz
						axbxc=cm	axbxc=cm	axbxc=cm	axbxc=cm				
Lift 100	10460103	8001244460102	6	2,65	15	100x43x135	10x5,5x102	22x18x106	6	144	121	142	
Lift 120	10460123	8001244460126	7	2,75	15	120x43x135	10x5,5x121,5	22x18x126	6	144	141	120	
Lift 140	10460143	8001244460140	8,5	3	15	140x43x135	10x5,5x142,5	22x18x147	6	144	162	103	
Lift 160	10460163	8001244460164	9,5	3,15	15	160x43x135	10x5,5x162,5	22x18x166	6	144	181	91	

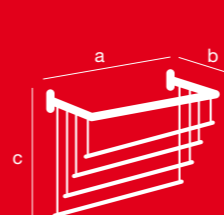

Item	Gimi	Ean	m	1 pz	kg	Aperto Open		Chiuso Folded		n° pz	n° pz	h=cm	n° pz
						axbxc=cm	axbxc=cm	axbxc=cm	axbxc=cm				
Unix	10830005	8001244870000	10	3,25	20	100-160x48x140-170	12,5x10x102,5	27,5x31x106	6	90	121	66	

# Stendibiancheria da giardino

# Garden

Materiale Material		Nome prodotto Item	Incluso Included	Optional Optional
Alluminio Aluminium	m 50	Garden	supporto ancoraggio terreno ground anchoring support	treppiede tripod support

## Un super ombrello di 50 m, resistente a pioggia, ruggine, corrosione!

**Categoria** Lega in alluminio  
**Dove** Per esterni  
**Quanto** 50 m  
**Perché** Si apre e si chiude in un attimo.  
 Grazie al supporto di ancoraggio al terreno (di serie) o al supporto mobile a treppiede (optional), è assolutamente stabile e facilmente removibile quando non serve

## A super umbrella of 50 m, resistant to rain, rust, and corrosion!

**Category** Aluminium alloy  
**Where** Outdoors  
**What size** 50 m  
**Why** It can be opened or closed in a second. Thanks to the support anchored to the ground (standard) or the mobile tripod support (optional), it is perfectly stable and easy to remove when no longer needed

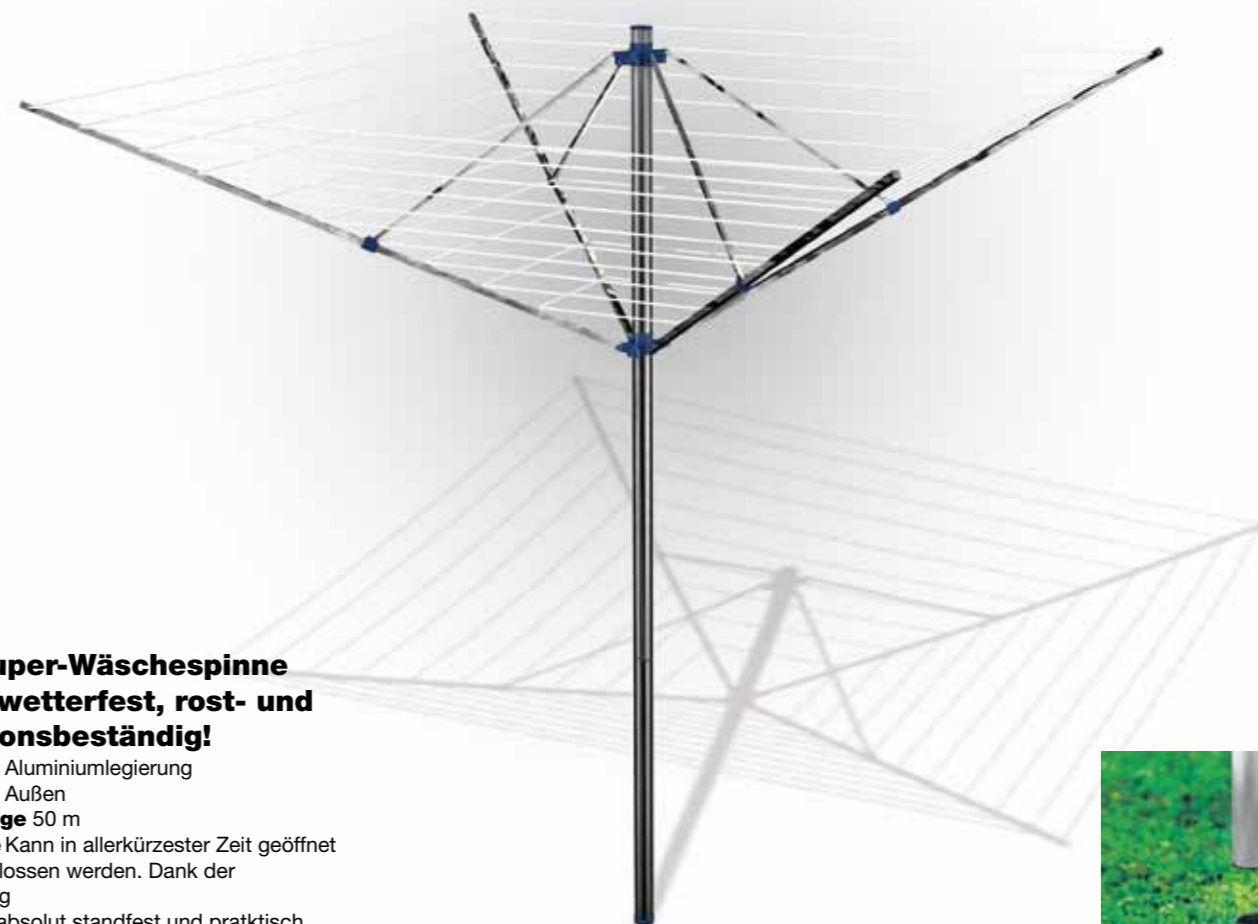

## Eine Super-Wäschespinne (50 m) wetterfest, rost- und korrosionsbeständig!

**Material** Aluminiumlegierung  
**Standort** Außen  
**Leinenlänge** 50 m  
**Merkmale** Kann in aller kürzester Zeit geöffnet oder geschlossen werden. Dank der Verankerung am Boden absolut standfest und praktisch zusammenklappbar

## Un parapluie extraordinaire de 50 m qui résiste à la pluie, à la rouille et à la corrosion!

**Catégorie** Alliage d'aluminium  
**Où** A l'extérieur  
**Combien** 50 m  
**Pourquoi** Il peut être ouvert et fermé en un clin d'oeil. Grâce à son support de fixation au sol (standard) ou au support mobile à trépied (en option), il est absolument stable et peut être enlevé aisément s'il n'est plus nécessaire

## ¡Un súper paraguas de 50 m resistente a la lluvia, al óxido y a la corrosión!

**Categoría** Aleación de aluminio  
**Dónde** Para exteriores  
**Cuánto** 50 m  
**Porqué** Se abre y se cierra en un instante. Gracias al soporte de anclaje al terreno (en serie) o al soporte móvil (opcional), es absolutamente estable y fácil de quitar cuando no sirve.

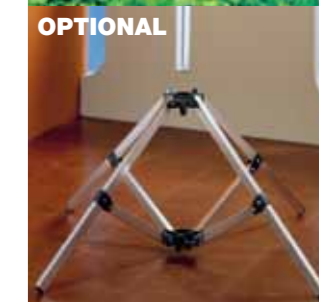

OPTIONAL

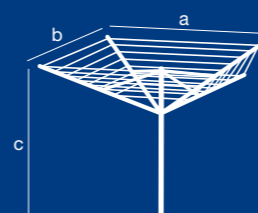

Item	Gimi	Ean	m	1 pz	kg	axbxc=cm	axbxc=cm	axbxc=cm	n° pz	n° pz	h=cm	n° pz
Garden	10250001	8001244302006	50	2,25	20	182x182x186	10x10x180	22,5x33,5x181,5	6	72	196,5	45
Supporto Garden	12760001	8001244100114	-	1,08	-	115x115x45,5	10x10x80	38x25x87,5	6	54	102,5	72

Per descrizioni dettagliate consultare le pagine dei singoli prodotti.  
 For more details please see the related product pages.

# Accessori per stendere

Categoria Category	Nome prodotto Item	Esclusiva Gimi Gimi exclusive	Altro Other
Asciugascarpe Tissue shoe hanger	Goccioline	✓	per tubi Ø 14-20 mm for tube Ø 14-20 mm
Stendibiancheria Clothes dryer	Soffio	✓	15 mollette 15 pegs
Portamollette Clothes-peg basket	Cigno	✓	16 mollette incluse 16 clothes pegs included
Proteggibucato Laundry cover	Cover 400		avvolgimento automatico automatic winding mechanism
	Tendy		

# Goccioline

## Ecco l'idea che mi serviva!

**Categoria** Resina opalina colorata  
**Dove** In casa o fuori, agganciate alla struttura di uno stendibiancheria a torre o a cavalletto

**Perché** Non si sa mai come stendere le scarpe da ginnastica o le pantofole dopo averle lavate: una funzione semplice ed utile interpretata dal design italiano

## A small useful idea!

**Category** Coloured opaline resin  
**Where** Indoor or outdoor, to be hanged from a tower or stand clothes-drier  
**Why** To hang out gym shoes or slippers after washing: a useful and practical Italian-designed idea

## Eine kleine hilfreiche Idee!

**Material** Farbiges Opalkunstharz  
**Standort** Zu Hause oder im Freien, zum Aufhängen auf einem vertikalen oder horizontalen Wäscheständer  
**Merkmale** Wenn man die Turnschuhe oder die Hausschuhe nach dem Waschen bequem aufhängen will: ein Vorteil ganz im Sinne des italienischen Designs

## Voici une petite idée utile

**Catégorie** Résine opaline colorée  
**Où** À la maison tout comme ailleurs, à accrocher à la structure d'un séchoir/étendoir vertical ou horizontal  
**Pourquoi** Si vous ne savez jamais comment sécher les chaussures de gymnastique ou les pantoufles après les avoir lavées, voici une idée simple et utile interprétée par le design italien

## ¡He aquí una pequeña y útil idea!

**Categoría** Resina opalina coloreada  
**Dónde** en casa o fuera, enganchadas a la estructura de un tendedero torre o de pie  
**Porqué** No se sabe nunca cómo tender las zapatillas deportivas ni las zapatillas para casa después de lavarlas: una función sencilla y útil, interpretada por el diseño italiano

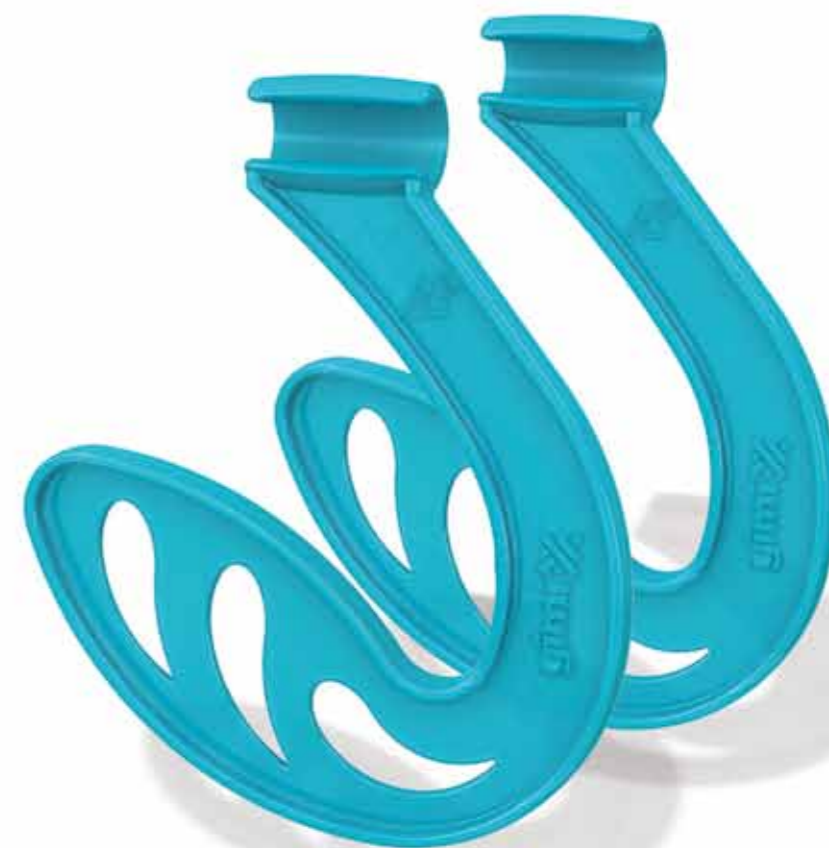

Item	Gimi	Ean	1 pz	kg	axbxc=cm	axbxc=cm	axbxc=cm	n° pz	n° pz	h=cm	n° pz
Goccioline	12270090	8001244008724	0,11	1	13,5x2x16,5	19x2,5x27	23x40x19,5	24	1200	112,5	1337

Per descrizioni dettagliate consultare le pagine dei singoli prodotti.  
For more details please see the related product pages.



# Soffio

## Il piccolo bucato asciutto in un soffio!

**Categoria** Struttura in resina opalina colorata, mollette in resina opalina neutra

**Quanto** 15 mollette per appendere calzini, intimo, fazzoletti e altri piccoli capi

**Perché** Senza occupare spazio sul filo o sullo stendibiancheria si appende ovunque: una funzione utile interpretata dal design italiano

## Small pieces dried out in a jiffy!

**Category** Coloured opaline resin construction, neutral opaline resin pegs

**What size** 15 pegs to hang out socks, underwear, handkerchiefs, and other small pieces

**Why** They can be hung from anywhere without taking up any room on the lines or the clothes-drier: a useful Italian designed idea

## Die Wäsche ist im Nu trocken!

**Material** Farbige Opalkunstharzstruktur, Wäscheklammern aus neutralem Opalkunstharz

**Kapazität** 15 Wäscheklammern zum Aufhängen von Socken, Unterwäsche, Taschentüchern und anderen kleinen Wäscheteilen

**Merkmale** Überall aufzuhängen, ohne Platz auf der Leine oder auf dem Wäscheständer zu beanspruchen: ein Vorteil ganz im Sinne des italienischen Designs



MARCOMAGGIOM  
DESIGN

## Le petit linge séché dans un souffle!

**Catégorie** Structure en résine opaline colorée, pinces en résine opaline neutre

**Combien** 15 pinces à linge pour sécher les chaussettes, la lingerie, les mouchoirs et tout autre petit vêtement

**Pourquoi** À suspendre où vous voulez, sans occuper de l'espace précieux sur les fils ou sur le séchoir/étendoir: une idée utile interprétée par le design italien

## ¡Las prendas pequeñas se secan en un soplo!

**Categoría** Estructura en resina opalina coloreada, pinzas en resina opalina neutra

**Cuánto** 15 pinzas para tender calcetines, ropa íntima, pañuelos y otras prendas pequeñas

**Porqué** Dejando libres las cuerdas o el tendedero, se puede tender en cualquier parte: una función útil interpretada por el diseño italiano



# Cigno

## Adesso il portamollette è inconfondibile!

**Categoria** Polietilene opalino

**Perché** È leggero e aggraziato come un cigno il portamollette nei colori ametista, rosa, arancio e blu, completo di 16 mollette intonate

## Now the clothes peg holder is unmistakable!

**Category** Opalescent polyethylene

**Why** Lightweight and smart like a swan. Available in amethyst, pink, orange and blue, it comes with 16 matching clothes pegs

## Der einzigartige Wäscheklammerbeutel!

**Material** Opalpolyethylen

**Merkmale** Leicht und niedlich wie ein Schwan ist der Wäscheklammerbeutel mit 16 dazu passenden Wäscheklammern in den Farben violett, rose, orange und blau erhältlich

## Un porte-épingles à linge unique!

**Matière** Polyéthylène opalescent

**Pourquoi** Léger et élégant comme un cygne, ce porte-épingles, disponible en couleur améthyste, rose, orange et bleu, est fourni avec 16 épingles assorties

## ¡Ahora el porta pinzas es inconfundible!

**Categoria** Polietileno opalino

**Porqué** Es ligero y bonito como una cigüeña el porta pinzas de colores amatista, rosa, anaranjado y azul, provisto de 16 pinzas de ropa del mismo color



MARCOMAGGIOM  
DESIGN

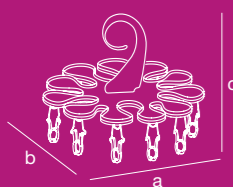

Item	Gimi	Ean	1 pz	kg	Aperto Open		Chiuso Folded		n° pz	n° pz	h=cm	n° pz
					axbxc=cm	axbxc=cm	axbxc=cm	n° pz				
Soffio	10750210	8001244008687	0,25	2	32x32x25	32x32x3,5	30x33x34	12	288	117	356	



Item	Gimi	Ean	1 pz	Aperto Open		Chiuso Folded		n° pz	n° pz	h=cm	n° pz
				axbxc=cm	axbxc=cm	axbxc=cm	n° pz				
Cigno	12100270	8001244007277	0,23	23x13x27	23x12,5x27	59,5x25x80	48	576	175	403	

# Cover 400

## Lo scudo a difesa del pulito!

**Categoria** Pvc  
**Dove** Esterno  
**Quanto** Si allunga fino a 4 m  
**Perché** Il telo allungabile ad avvolgimento automatico indispensabile per coprire il bucato in caso di pioggia. Per proteggere dallo smog e dall'azione sbiancante del sole: un'idea fantastica da agganciare a qualunque stendibiancheria gimì

## The best way to keep things clean!

**Category** Pvc  
**Where** Outdoors  
**What size** Extends up to 4 m  
**Why** The extendable sheet has an automatic winding mechanism and is indispensable for covering your washing in case of rain. To protect your washing from smog and the bleaching action of the sun: a fantastic idea that can be hooked onto any gimì's clothes-dryer



## Das Schutzschild für saubere Wäsche!

**Material** Pvc  
**Standort** Außen  
**Maße** Bis zu 4 m  
**Merkmale** Das verlängerbare Tuch mit automatischer Aufwicklung zur Abdeckung der Wäsche im Falle von Regen, zum Schutz vor Smog und Ausbleichen durch Sonnenstrahlung: eine fantastische Idee, nutzbar für jeden Wäscheständer gimì

## Une protection pour votre linge!

**Matière** Pvc  
**Où** A l'extérieur  
**Combien** Allongeable jusqu'à 4 m  
**Pourquoi** Une bâche allongeable s'enroulant automatiquement, indispensable pour couvrir le linge en cas de pluie et pour le protéger du smog et de l'action blanchissante du soleil: une idée fantastique à accrocher à n'importe quel séchoir/étendoir gimì

## ¡El escudo en defensa de la limpieza!

**Categoría** Pvc  
**Dónde** Externo  
**Cuánto** Se extiende hasta 4 m.  
**Porqué** La lona extensible de enrollamiento automático indispensable para cubrir la ropa lavada en caso de lluvia y para protegerla contra el smog y la acción decolorante del sol: una idea fantástica que puede engancharse a cualquier tendedero de ropa gimì



# Tendy

## Semplice, elegante, conveniente!

**Perché** Telo in pvc extra conveniente e sagomato per coprire lo stendibiancheria in caso di pioggia

## Simple, elegant and practical!

**Why** The Pvc sheet is really practical. It's designed to cover the clothes-drier in case of rain

## Einfach, elegant und preiswert!

**Merkmale** Tuch in PVC (besonders günstig), geformt zur Abdeckung der Wäscheständer gegen Regen



## Simple, élégante et avantageuse!

**Pourquoi** Bâche en PVC extrêmement avantageuse ; elle est modelée de manière à couvrir le séchoir/étendoir en cas de pluie

## ¡Sencillo, elegante y conveniente!

**Porqué** Lona de PVC extra conveniente y moldeada para cubrir el tendedero de ropa en caso de lluvia



Item	Gimi	Ean	1 pz	axbxc=cm	axbxc=cm	axbxc=cm	n° pz	n° pz	h=cm	n° pz	Kg	Aperto Open		Chiuso Folded	
												axbxc=cm	axbxc=cm	axbxc=cm	n° pz
Cover 400	12140535	8001244002746	1,23	60x400x4,5	20x6x66,5	16,5x24,5x65	6	150	80	228					



Item	Gimi	Ean	1 pz	axbxc=cm	axbxc=cm	axbxc=cm	n° pz	n° pz	h=cm	n° pz	Kg	Aperto Open		Chiuso Folded	
												axbxc=cm	axbxc=cm	axbxc=cm	n° pz
Tendy	12720500	8001244000865	0,52	200x60	21,5x2,5x28,5	47x24x31	24	672	139	686					

# Assi da stiro

Piano rete Board size	Nome prodotto Item	Plus					
		Poggiaferro Iron rest	Portacaldaia Boiler rest	Griglia portabiancheria Clothes rack	Presa elettrica Electric plug	Antenna reggifilo Wire holder support	Altro/note Other/notes
cm 73 x 32	Pollicino						da tavolo - appendibile table - hangable
cm 110 x 33	Leo Art Line	✓					
cm 122 x 38	Roy Art Line	✓					
cm 126 x 45	Andy Art Line	✓	✓	✓			
cm 110 x 33	Junior Drop Line	✓*					* in filo di acciaio cromato chromed steel wire
cm 110 x 33	Classic Drop Line	✓					
cm 110 x 33	Trim Drop Line	✓					pedini regolabili adjustable feet
cm 122 x 38	Prestige Drop Line	✓		✓		✓	
cm 122 x 38	Eden Drop Line	✓		✓		✓	
cm 122 x 38	Uniko Drop Line	✓	✓	✓	✓	✓	griglia portabiancheria estraibile foldaway clothes rack
cm 122 x 40	Temper Drop Line	✓				✓	pedini regolabili adjustable feet
cm 122 x 40	Poker Drop Line	✓		✓		✓	pedini regolabili adjustable feet griglia portabiancheria estraibile foldaway clothes rack
cm 126 x 45	Golden Drop Line	✓	✓	✓		✓	porta grucce hanger support
cm 126 x 45	Mitiko Drop Line	✓	✓	✓	✓	✓	griglia portabiancheria estraibile foldaway clothes rack
cm 126 x 48	Prisma Drop Line	✓	✓	✓	✓	✓	pedini regolabili adjustable feet griglia portabiancheria estraibile foldaway clothes rack
cm 122 x 38	Advance 100	✓		✓		✓	prolunga reggilenzuola sheets holder
cm 122 x 38	Advance 120	✓		✓		✓	prolunga reggilenzuola sheets holder
cm 126 x 45	Advance 140	✓	✓	✓		✓	prolunga reggilenzuola sheets holder

# Pollicino

## L'asse da stiro da posare sul tavolo, velocità e praticità insieme!

**Quanto** Piano rete dimensioni 73 x 32 cm  
**Categoria** Telaio in tubo di acciaio verniciato.  
 Piano in rete elettrosaldato per una migliore dispersione del vapore.  
 Foderina 100% cotone con mollettone  
**Perché** Per stirare agevolmente anche in uno spazio minimo. È pratico, leggero, può essere appeso con il suo gancio ed è decisamente conveniente.

## The ironing board for the table: both quick and practical!

**What size** Board size 73 x 32 cm  
**Category** Frame made of painted steel tube.  
 Electrowelded net board for better steam dispersion.  
 100% cotton ironing board cover with felt pad  
**Why** To iron comfortably, even in a very small space Very cheap, practical and light, it can be hung from its hook.



## Das Bügelbrett zum Bügeln auf dem Küchen- oder Esstisch, schnell und praktisch zugleich!

**Größe** Bügelfläche Größe 73 x 32 cm  
**Material** Stahlrohrgestell, lackiert.  
 Bügelbrett mit elektrogeschweißtem Gitter, um die Dampfsorgung zu optimieren.  
 Bügeltischbezug aus 100% Baumwolle mit Moltonunterseite  
**Merkmale** Praktisch, leicht, preiswert und platzsparend. Kann dank dem Haken auch aufgehängt werden.

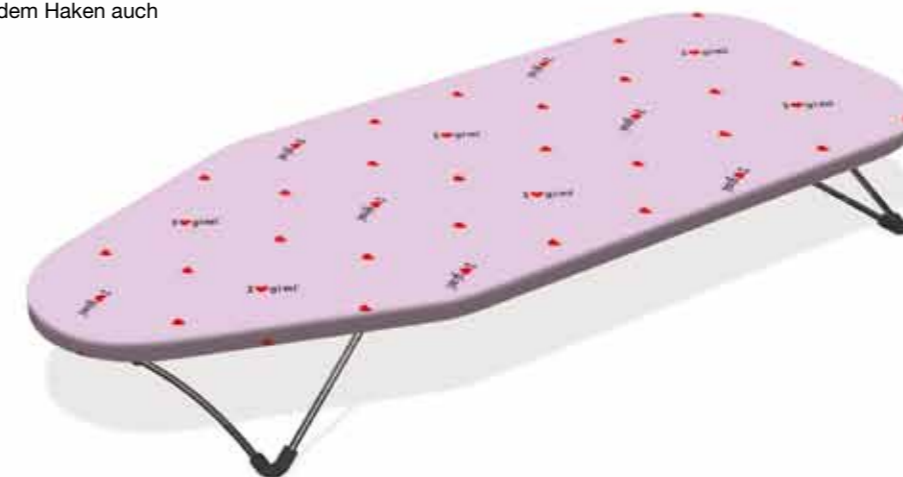

## La planche à repasser pour la table: à la fois, rapide et pratique!

**Combien** Plateau 73 x 32 cm  
**Catégorie** Cadre en tube d'acier peint.  
 Plateau en filet électrosoudé pour une meilleure dispersion de la vapeur.  
 Housse en coton 100% avec molleton pour table à repasser  
**Pourquoi** Pour repasser aisément aussi dans un espace très réduit. Très bon marché, légère et pratique, elle peut être suspendue à son crochet.

## ¡Tabla de planchar para apoyar sobre la mesa: ¡velocidad y practicidad!

**Cuánto** Plano de red dimensiones 73 x 32 cm  
**Categoría** Bastidor de tubo de acero barnizado.  
 Base para apoyar la plancha de red electrosoldada para dispersar mejor el vapor.  
 Funda de algodón 100% con muletón para tablas de planchar  
**Por qué** Para planchar sin dificultades incluso en un espacio muy reducido. Es práctica, ligera, se puede colgar del gancho que incorpora y es indudablemente conveniente.



Per descrizioni dettagliate consultare le pagine dei singoli prodotti.  
 For more details please see the related product pages.



Item	Gimi	Ean	1 pz	axbxc=cm	axbxc=cm	axbxc=cm	n° pz	n° pz	h=cm	n° pz	Kg		Aperto Open		Chiuso Folded	
											Icona	Icona	Icona	Icona		
Pollicino	14624600	8001244010185	1,27	73,5x32x12,5	32x2x73,5	34x15,5x76	8	136	91	199						



## Una soluzione semplice e robusta!

**Quanto** Piano rete dimensioni 110 x 33 cm  
**Categoria** Telaio inferiore in tubo di acciaio verniciato. Nuova vaschetta poggiaferro in lamiera verniciata con inserti in silicone termoresistente e foderina 100% cotone con mollettone  
**Perché** per chi desidera un asse semplice con poco ingombro

## A simple and sturdy solution!

**What size** Board size 110 x 33 cm  
**Category** Bottom frame made of painted steel tube. New iron rest in painted sheet metal with heatresistant silicone inserts and 100% cotton ironing board cover with felt pad  
**Why** for people who want a simple ironing board that doesn't take up much space

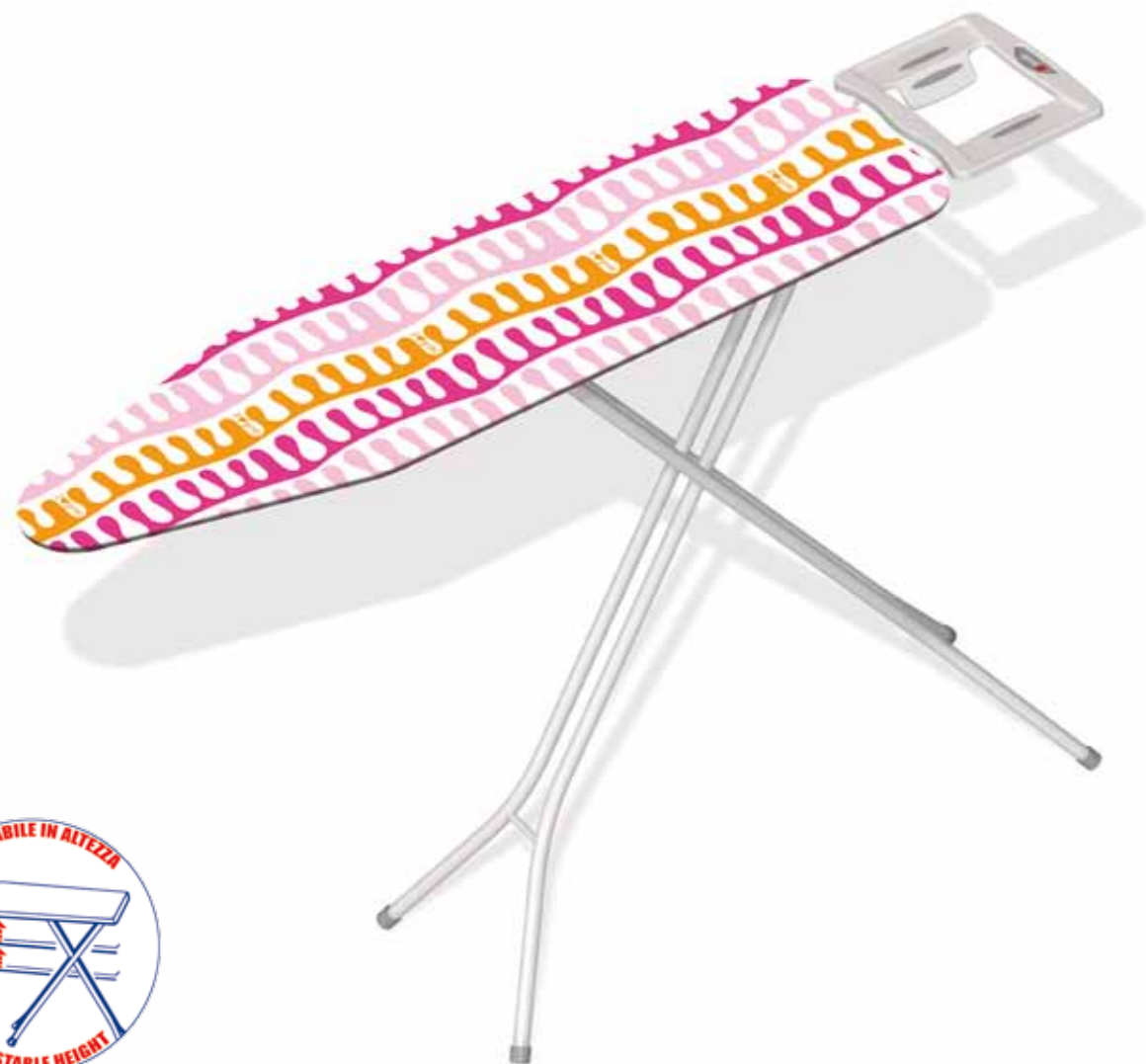

## Eine einfache und robuste Lösung!

**Maße** Auflagefläche 110 x 33 cm  
**Material** Untergestell aus lackiertem Stahlrohr. Neue Bügeleisenhalterung aus lackiertem Blech mit wärmebeständigen Silikoneinsätzen und Bügeltischbezug aus 100% Baumwolle mit Moltonunterseite  
**Merkmale** Wenn man sich ein einfaches und Platz sparendes Bügelbrett wünscht

## Une solution simple et robuste!

**Taille** Plateau 110 x 33 cm  
**Matériaux** Structure inférieure en tube d'acier peint. Nouveau repose-fer en tôle peinte avec des inserts en silicone thermorésistante et housse 100% coton avec molleton  
**Avantages** Table à repasser simple aux dimensions très réduites

## ¡Una solución sencilla y robusta!

**Cuánto** Superficie de planchado 110 x 33 cm  
**Categoría** Bastidor inferior en tubo de acero pintado. Nueva bandeja apoya plancha de chapa pintada con insertos de silicona termorresistente y funda 100% algodón con muletón  
**Porqué** Para quien desea una tabla sencilla con poco volumen



Item	Gimi	Ean	Ø	1 pz	Aperto Open		Chiuso Folded		n° pz	n° pz	h=cm	n° pz
					axbxc=cm	axbxc=cm	axbxc=cm	axbxc=cm				
Leo	14100360	8001244011175	19 mm	3,60	110x33x90	33x3,8x141	33,5x16,5x142,5	4	68	157,5	50	



## Il mix perfetto tra spazio e comodità!

**Quanto** Piano rete dimensioni 122 x 38 cm  
**Categoria** Telaio inferiore in tubo di acciaio verniciato. Nuova vaschetta poggiaferro in lamiera verniciata con inserti in silicone termoresistente e foderina 100% cotone con mollettone  
**Perché** per stirare comodamente capi di ogni dimensione; completo di griglia inferiore portabiancheria

## The perfect mix of space and convenience!

**What size** Board size 122 x 38 cm  
**Category** Bottom frame made of painted steel tube. New iron rest in painted sheet metal with heat resistant silicone inserts and 100% cotton ironing board cover with felt pad  
**Why** for easily ironing garments of any size; complete with bottom clothes rack



## Der perfekte Mix zwischen Platzersparnis und Zweckmäßigkeit!

**Maße** Auflagefläche 122 x 38 cm  
**Material** Untergestell aus lackiertem Stahlrohr. Neue Bügeleisenhalterung aus lackiertem Blech mit wärmebeständigen Silikoneinsätzen und Bügeltischbezug aus 100% Baumwolle mit Moltonunterseite  
**Merkmale** Wenn man bequem große Wäsche bügeln möchte. Mit Gittergestell zur Wäscheablage unter der Bügelfläche

## L'alliance parfaite entre le confort et l'économie d'espace!

**Taille** Plateau 122 x 38 cm  
**Matériaux** Structure inférieure en tube d'acier peint. Nouveau repose-fer en tôle peinte avec des inserts en silicone thermorésistante et housse 100% coton avec molleton  
**Avantages** Pour le repassage aisé de tout type de linge; la table est pourvue d'une grille inférieure repose-linge

## ¡La mezcla perfecta de espacio y comodidad!

**Cuánto** Superficie de planchado 122 x 38 cm  
**Categoría** Bastidor inferior en tubo de acero pintado. Nueva bandeja apoya plancha de chapa pintada con insertos de silicona termorresistente y funda 100% algodón con muletón  
**Porqué** Para planchar cómodamente ropa de cualquier tamaño; completo con rejilla inferior para colocar la ropa



Item	Gimi	Ean	Ø	1 pz	Aperto Open		Chiuso Folded		n° pz	n° pz	h=cm	n° pz
					axbxc=cm	axbxc=cm	axbxc=cm	axbxc=cm				
Roy	14630355	8001244011199	22 mm	4,80	122x38x90	38x6x152	39x23x152,5	4	40	167,5	29	



### Piano di stiro ampio e pratica struttura

**Quanto** Piano rete dimensioni 126 x 45 cm  
**Categoria** Telaio inferiore in tubo di acciaio verniciato a sezione rettangolare. Nuova vaschetta poggiaferro/portacaldaia in lamiera verniciata con inserti in silicone termoresistente, dotata di profilo contenitivo. Foderina 100% cotone con mollettone  
**Perché** Comodo e stabile, senza pesare troppo, completo di griglia inferiore portabiancheria

### Wide board and practical structure

**What size** Board size 126 x 45 cm  
**Category** Bottom frame made of painted steel tube with a rectangular section. New iron rest/boiler rest in painted sheet metal with heat resistant silicone inserts and a raised edge for safety. 100% cotton ironing board cover with felt pad  
**Why** Comfortable and steady, not too heavy, complete with bottom clothes rack

### Il più leggero e conveniente!

**Quanto** Piano rete dimensioni 110x33 cm  
**Categoria** Telaio inferiore in tubo di acciaio verniciato.  
 Poggiaferro in filo di acciaio cromato. Foderina 100% cotone con mollettone  
**Perché** per chi ha poco spazio e desidera risparmiarne

### The lightest, and best value for money!

**What size** Board size: 110 x 33 cm  
**Category** Bottom frame made of painted steel tube. Iron rest made of chromed steel wire. 100% cotton ironing board cover with felt pad  
**Why** For those with not a lot of space, looking for a bargain

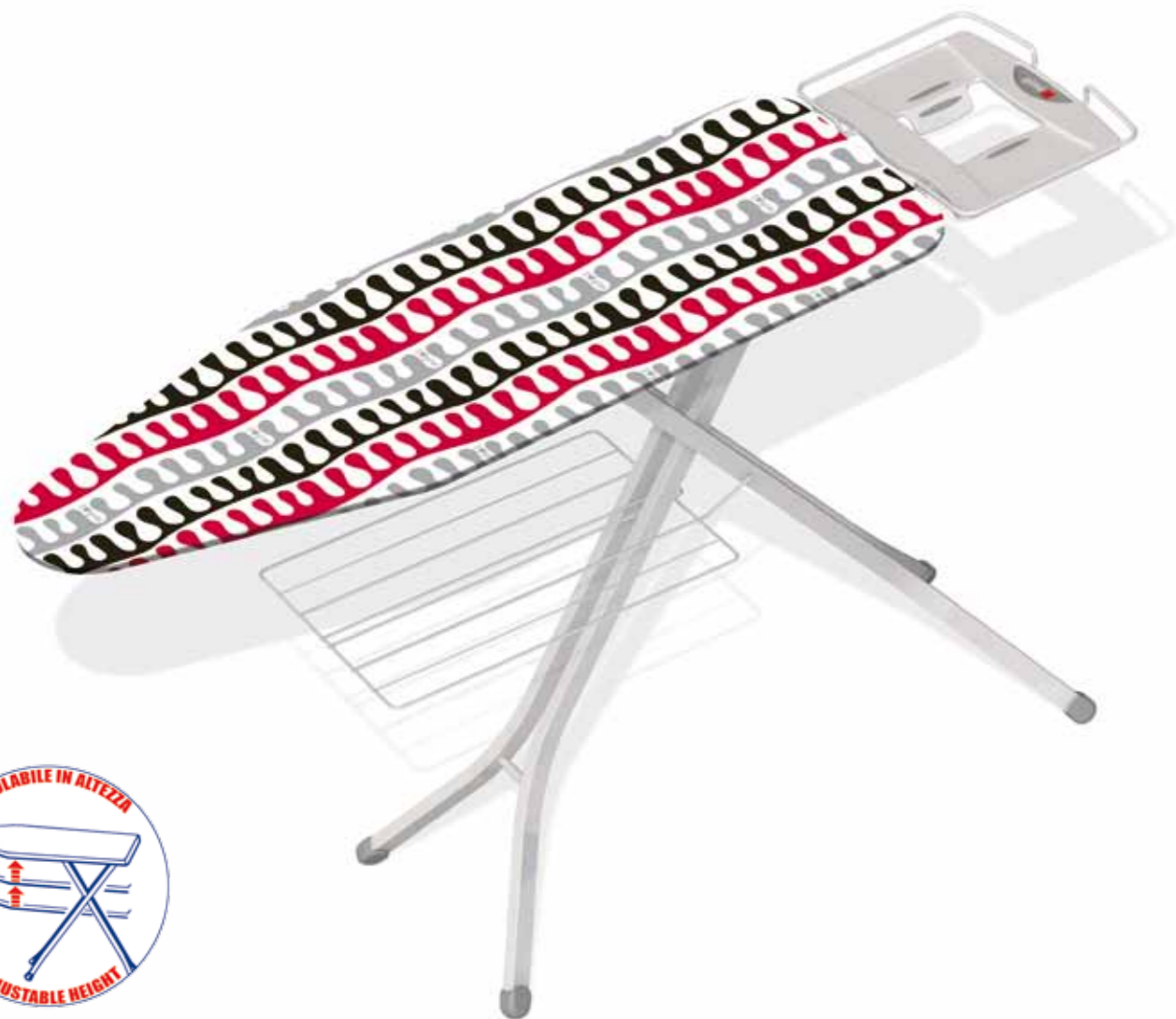

### Große Bügelfläche und eine praktische

**Maße** Auflagefläche 126 x 45 cm  
**Material** Untergestell aus lackiertem viereckigem Stahlrohr. Neue Bügeleisen-/Heizkesselhalterung aus lackiertem Blech mit wärmebeständigen Silikoninserten und Rahmenprofil. Bügeltischbezug aus 100% Baumwolle mit Moltonunterseite  
**Merkmale** Praktisch und stabil und doch nicht schwer. Mit Gittergestell zur Wäscheablage unter der Bügelfläche

### Plateau ample et structure pratique

**Taille** Plateau 126 x 45 cm  
**Matériaux** Structure inférieure en tube d'acier peint à section rectangulaire. Nouveau repose-fer/chaudière en tôle vernie avec inserts en silicone thermorésistante, au profil relevé. Housse 100% avec molleton  
**Avantages** Table à repasser confortable et stable, légère, pourvue de grille inférieure repose-linge

### Amplia superficie de planchado y práctica estructura

**Cuánto** Superficie de planchado 126 x 45 cm  
**Categoría** Bastidor inferior en tubo de acero pintado en sección rectangular. Nueva bandeja apoya plancha/posa caldera en chapa pintada con insertos de silicona termorresistente, equipada con borde protectorio. Funda 100% algodón con muletón  
**Porqué** Cómodo y estable, sin peso excesivo, completo con rejilla inferior para apoyar la ropa

### Das leichteste und preisgünstigste Bügelbrett!

**Maße** Auflagefläche 110 cm x 33 cm  
**Material** Untergestell aus lackiertem Stahlrohr, Bügeleisenhalterung aus lackiertem Blech.  
 Bügeltischbezug aus 100% Baumwolle mit Moltonunterseite  
**Merkmale** Höchste Solidität und Stabilität

### Le plus léger et le plus avantageux!

**Taille** Plateau 110 x 33 cm  
**Matériaux** Structure inférieure en tube d'acier peint. Repose-fer en acier chromé. Housse en coton 100% avec molleton pour table à repasser  
**Atout** Peu encombrant et un prix très abordable

### ¡La más liviana y conveniente!

**Cuánto** Dimensiones del tablero de red expandida 110 x 33 cm  
**Categoría** bastidor inferior en tubo de acero pintado, reposa-plancha en hilo de acero cromado. Funda de algodón 100% con muletón para tablas de planchar  
**Porqué** para quien dispone de poco espacio y desea ahorrar

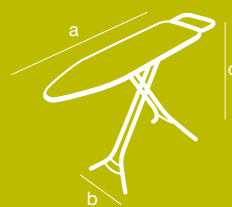

Item	Gimi	Ean	Aperto Open	Chiuso Folded	1 pz	axbxc=cm	axbxc=cm	axbxc=cm	n° pz	n° pz	h=cm	n° pz
Andy	14270370	8001244011212										

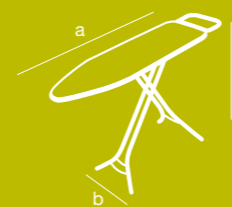

Item	Gimi	Ean	Aperto Open	Chiuso Folded	1 pz	axbxc=cm	axbxc=cm	axbxc=cm	n° pz	n° pz	h=cm	n° pz
Junior	14400550	8001244008823										

# Classic

Drop Line



## Una soluzione semplice e robusta!

**Quanto** Piano rete dimensioni 110 x 33 cm

**Categoria** Telaio inferiore in tubo di acciaio verniciato.

Poggiaferro in lamiera verniciata.

Foderina 100% cotone con mollettone

**Perché** Maggior solidità e stabilità

Archetto poggiaferro reversibile per mancini

## A simple and strong solution!

**What size** Board size: 110 x 33 cm

**Category** Bottom frame made of painted steel tube.

Iron rest made of painted sheet metal.

100% cotton ironing board cover with felt pad

**Why** Greater solidity and stability

Reversible iron rest holder for left-handed



## Eine einfache und robuste Lösung!

**Maße** Auflagefläche 110 cm x 33 cm

**Material** Untergestell aus lackiertem Stahlrohr, Bügeleisenhalterung aus lackiertem Blech. Bügeltischbezug aus 100% Baumwolle mit Moltonunterseite

**Merkmale** Höchste Solidität und Stabilität  
Bügeleisenhalter, für Linkshänder verstellbar

## Une solution simple et robuste!

**Taille** Plateau 110 x 33 cm

**Matériaux** Structure inférieure en tube d'acier peint. Repose-fer en tôle vernie. Housse en coton 100% avec molleton pour table à repasser

**Avantages** Plus solide et plus stable  
Repose fer réversible pour gaucher

## ¡Una solución sencilla y sólida!

**Cuánto** Dimensiones del tablero de red expandida 110 x 33 cm

**Categoría** Bastidor inferior en tubo de acero pintado.

Reposa-plancha en chapa pintada. Funda de algodón 100% con muletón para tablas de planchar

**Porqué** Mayor solidez y estabilidad  
Soporte para la plancha reversible para zurdos

# Trim

Drop Line



## Design originale del telaio inferiore!

**Quanto** Piano rete dimensioni 110 x 33 cm

**Categoria** Telaio inferiore in tubo di acciaio verniciato.

Poggiaferro in lamiera verniciata.

Foderina 100% cotone con mollettone

**Perché** Una nuova apertura per le gambe d'appoggio.

Archetto poggiaferro reversibile per mancini

## Original bottom frame design!

**What size** Board size: 110 x 33 cm

**Category** Bottom frame made of painted steel tube.

Iron rest made of painted sheet metal.

100% cotton ironing board cover with felt pad

**Why** New opening for legs.

Reversible iron rest holder for left-handed

## Originelles Design des Untergestells!

**Maße** Auflagefläche 110 cm x 33 cm

**Material** Untergestell aus lackiertem Stahlrohr.

Bügeleisenhalterung aus lackiertem Blech.

Bügeltischbezug aus 100% Baumwolle mit Moltonunterseite

**Merkmale** Ein neuer Klappverschluss für die Standbeine.  
Bügeleisenhalter, für Linkshänder verstellbar



## Dessin original de la structure inférieure!

**Taille** Plateau 110 x 33 cm

**Matériaux** Structure inférieure en tube d'acier peint. Repose-fer en tôle vernie.

Housse en coton 100% avec molleton pour table à repasser

**Avantages** Une nouvelle ouverture pour les pieds d'appui.

Repose fer réversible pour gaucher

## ¡Estructura inferior de diseño original!

**Cuánto** Dimensiones del tablero de red expandida 110 x 33 cm

**Categoría** Bastidor inferior en tubo de acero pintado. Reposa-plancha en chapa pintada.

Funda de algodón 100% con muletón para tablas de planchar

**Porqué** Una nueva apertura para las patas de apoyo.

Soporte para la plancha reversible para zurdos

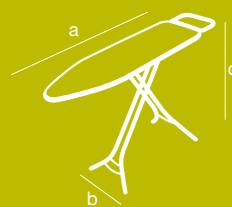

Item	Gimi	Ean	⊙	1 pz	axbxc=cm	axbxc=cm	axbxc=cm	n° pz	n° pz	h=cm	n° pz
Classic	14100350	8001244008854	22 mm	4,75	110x33x90	33x4,8x143	34,5x20,5x144	4	48	159	39

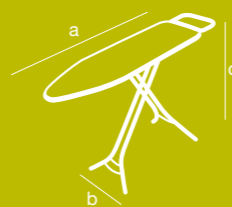

Item	Gimi	Ean	⊙	1 pz	axbxc=cm	axbxc=cm	axbxc=cm	n° pz	n° pz	h=cm	n° pz
Trim	14790353	8001244008977	22 mm 32 mm	5,25	110x33x90	33x6,5x147,5	34,5x27x149	4	40	164	28

# Prestige

Drop Line



## Un piano più ampio!

**Quanto** Piano rete dimensioni 122 x 38 cm  
**Categoria** Telaio inferiore in tubo di acciaio verniciato.

Poggiaferro in lamiera verniciata.

Foderina 100% cotone con mollettone

**Perché** per stirare comodamente capi di ogni dimensione; completo di griglia inferiore portabiancheria.

Archetto poggiaferro reversibile per mancini

## A bigger board!

**What size** Board size: 122 x 38 cm  
**Category** Bottom frame made of painted steel tube.

Iron rest made of painted sheet metal.

100% cotton ironing board cover with felt pad

**Why** To easily iron garments of any size; complete with bottom clothes rack.

Reversible iron rest holder for left-handed



## Eine größere Arbeitsfläche!

**Maße** Auflagefläche 122 cm x 38 cm

**Material** Untergestell aus lackiertem Stahlrohr. Bügeleisenhalterung aus lackiertem Blech. Bügeltischbezug aus 100% Baumwolle mit Moltonunterseite

**Merkmale** Zum komfortablen Bügeln von Kleidungsstücken jeder Größe; mit einem unteren Gitter zur Wäscheablage. Bügeleisenhalter, für Linkshänder verstellbar

## Une planche plus grande!

**Taille** Plateau 122 x 38 cm

**Matériaux** Structure inférieure en tube d'acier peint. Repose-fer en tôle vernie. Housse en coton 100% avec molleton pour table à repasser

**Avantages** Pour repasser de manière confortable tout vêtement de n'importe quelle dimension. Elle est pourvue d'une grille reposelinge. Repose fer réversible pour gaucher

## ¡Un tablero más grande!

**Cuánto** Dimensiones del tablero de red expandida 122 x 38 cm

**Categoría** bastidor inferior en tubo de acero pintado. Reposaplancha en chapa pintada. Funda de algodón 100% con muletón para tablas de planchar

**Porqué** para planchar cómodamente prendas de diferentes tamaños; con rejilla inferior para apoyar la ropa incluida. Soporte para la plancha reversible para zurdos

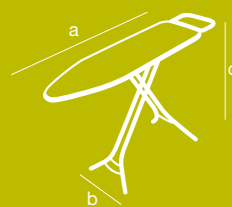

Item	Gimi	Ean	Ø	1 pz	Aperto Open		Chiuso Folded		n° pz	n° pz	h=cm	n° pz
					axbxc=cm	axbxc=cm	axbxc=cm	n° pz				
Prestige	14630348	8001244008878	22 mm	6,40	122x38x90	38x6x153	39,5x24x154	4	40	169	27	

# Eden

Drop Line



## Ancor più elegante con il telaio a sezione ovale!

**Quanto** Piano rete dimensioni 122x38 cm  
**Categoria** Telaio inferiore in tubo di acciaio verniciato a sezione ovale.

Poggiaferro in lamiera verniciata.

Foderina 100% cotone con mollettone

**Perché** curato in ogni particolare e completo di griglia inferiore portabiancheria.

Archetto poggiaferro reversibile per mancini

## Even more smart, with oval section frame!

**What size** Board size: 122 x 38 cm

**Category** Bottom frame made of painted steel tube, oval section.

Iron rest made of painted sheet metal.

100% cotton ironing board cover with felt pad

**Why** Meticulous attention to detail, comes with bottom clothes rack.

Reversible iron rest holder for left-handed

## Eleganter durch ein Gestell mit ovalem Querschnitt!

**Maße** Auflagefläche 122 cm x 38 cm

**Material** Untergestell aus lackiertem Stahlrohr mit ovalem Querschnitt.

Bügeleisenhalterung aus lackiertem Blech.

Bügeltischbezug aus 100% Baumwolle mit Moltonunterseite

**Merkmale** Größte Widerstandsfähigkeit und auch nach Jahren unverändertes Aussehen. Mit einem unteren Gitter zur Wäscheablage.

Bügeleisenhalter, für Linkshänder verstellbar

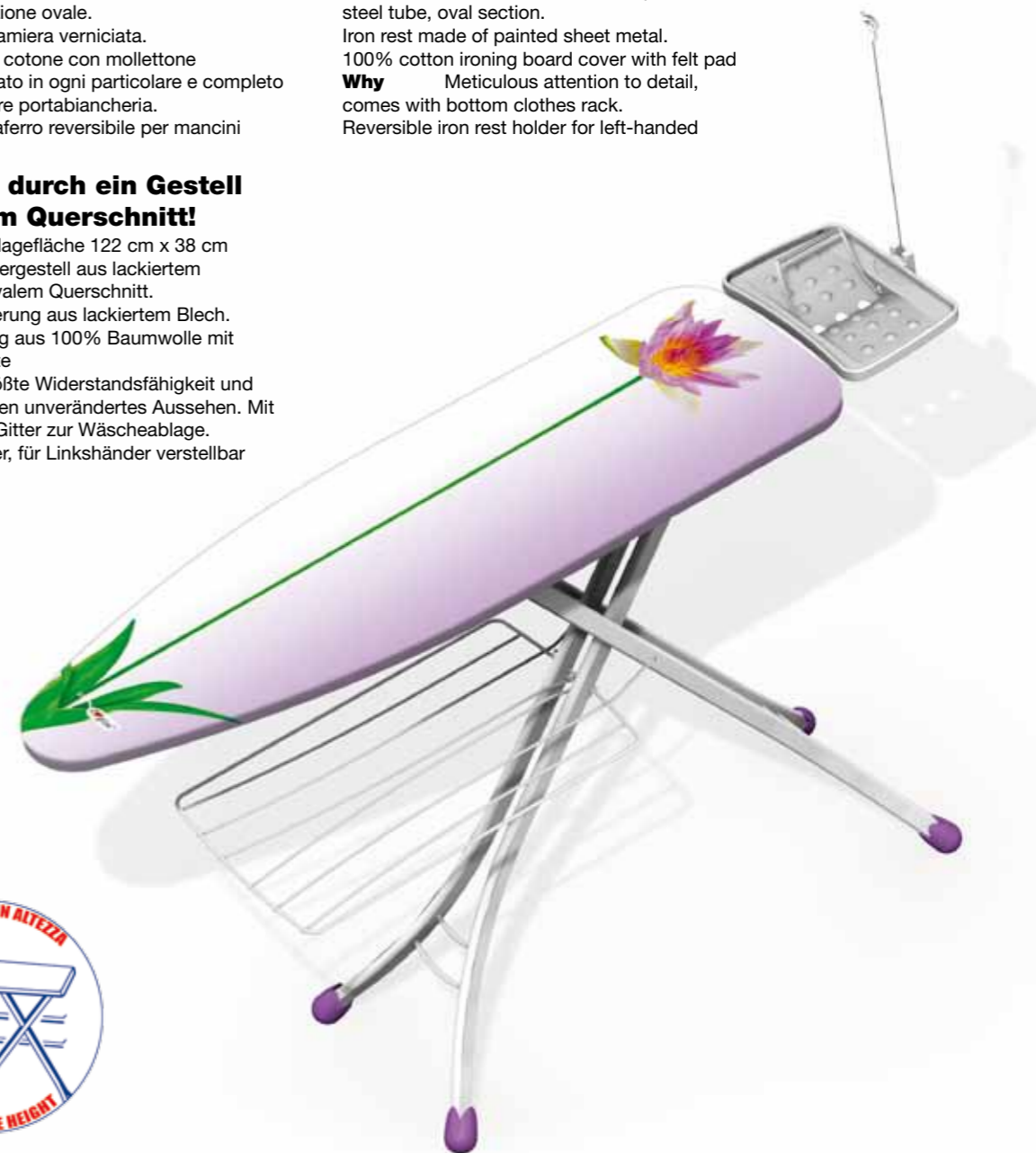

## Bien plus d'élégance grâce à sa structure en section ovale!

**Taille** Plateau 122 x 38 cm

**Matériaux** Structure inférieure en tube d'acier peint en section ovale. Repose-fer en tôle vernie.

Housse en coton 100% avec molleton pour table à repasser

**Avantages** Détails soignés. Elle est pourvue d'une grille repose-linge.

Repose fer réversible pour gaucher

## ¡Aún más elegante con el estructura de sección oval!

**Cuánto** Dimensiones del tablero de red expandida 122 x 38 cm

**Categoría** Estructura inferior en tubo de acero pintado de sección oval. Reposaplancha en chapa pintada. Funda de algodón 100% con muletón para tablas de planchar

**Porqué** Cuidada en cada uno de sus detalles y con rejilla inferior para apoyar la ropa incluida. Soporte para la plancha reversible para zurdos

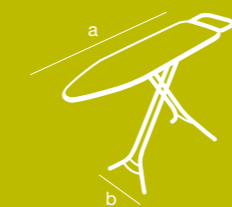

Item	Gimi	Ean	Ø	1 pz	Aperto Open		Chiuso Folded		n° pz	n° pz	h=cm	n° pz
					axbxc=cm	axbxc=cm	axbxc=cm	n° pz				
Eden	14170360	8001244008915	32x18 mm	7,30	122x38x90	38x7x152,5	39,5x15x154	2	30	169	21	



## Tutta la bellezza e la raffinatezza dell'acciaio!

**Quanto** Piano rete dimensioni cm 122 x 38  
**Categoria** Telaio inferiore in tubo di acciaio verniciato a sezione ovale.  
 Poggiaferro/portacaldaia in acciaio verniciato.  
 Foderina 100% cotone con mollettone  
**Perché** Con griglia portapanni estraibile lateralmente, ha un design impeccabile.  
 Archetto poggiaferro reversibile per mancini

## The beauty and charm of steel!

**What size** Board size: 122 x 38 cm  
**Category** Bottom frame made of painted steel tube, oval section.  
 Iron/boiler rest made of painted steel.  
 100% cotton ironing board cover with felt pad  
**Why** With a clothes rack that can be pulled out from the side, it has an impeccable design.  
 Reversible iron rest holder for left-handed

## Die Schönheit und Raffinertheit des Stahls!

**Maße** Auflagefläche 122 cm x 38 cm  
**Material** Untergestell aus lackiertem Stahlrohr mit ovalem Querschnitt.  
 Bügeleisenhalterung/Halterung für Wassertank von Bügelstationen aus lackiertem Stahl.  
 Bügeltischbezug aus 100% Baumwolle mit Moltonunterseite  
**Merkmale** Seitlich angebrachte, abnehmbare Wäscheablage mit einem gelungenen Design.  
 Bügeleisenhalter, für Linkshänder verstellbar



## Toute la beauté et tout le raffinement de l'acier!

**Taille** Plateau 122 x 38 cm  
**Matériaux** Structure inférieure en tube d'acier peint en section ovale.  
 Repose-fer en acier peint pour centrale vapeur.  
 Housse en coton 100% avec molleton pour table à repasser  
**Avantages** Grille repose-linge amovible latéralement et un design impeccable.  
 Repose fer réversible pour gaucher

## ¡Toda la belleza y la elegancia del acero!

**Cuánto** Dimensiones del tablero de red expandida 122 x 38 cm  
**Categoría** Estructura inferior en tubo de acero pintado de sección oval. Soporte especial en acero pintado para calderas de vapor. Funda de algodón 100% con muletón para tablas de planchar  
**Porqué** Con rejilla para apoyar la ropa extraíble lateralmente, presenta un diseño impecable.  
 Soporte para la plancha reversible para zurdos

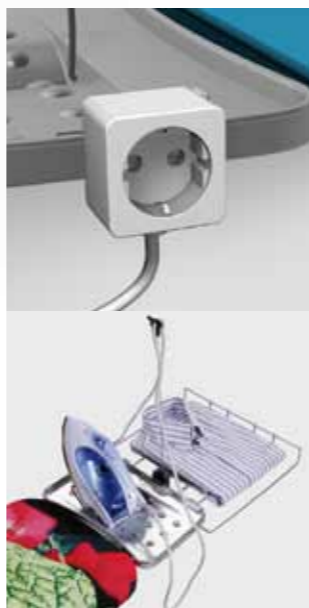

## Stile e praticità!

**Quanto** Piano rete dimensioni 122 x 40 cm  
**Categoria** Telaio inferiore in tubo di acciaio verniciato.  
 Poggiaferro in lamiera verniciata.  
 Foderina 100% cotone con mollettone  
**Perché** la soluzione perfetta per unire design e comodità.  
 Archetto poggiaferro reversibile per mancini

## Stil und Zweckmäßigkeit!

**Maße** Auflagefläche 122 x 40 cm  
**Material** Untergestell aus lackiertem Stahlrohr.  
 Bügeleisenhalterung aus lackiertem Blech.  
 Bügeltischbezug aus 100% Baumwolle mit Moltonunterseite  
**Merkmale** Die perfekte Lösung aus Design und Komfort.  
 Bügeleisenhalter, für Linkshänder verstellbar



## Pratique avec du style!

**Taille** Plateau 122 x 40 cm  
**Matériaux** Structure inférieure en tube d'acier peint. Repose-fer en tôle vernie.  
 Housse en coton 100% avec molleton pour table à repasser  
**Avantages** La solution idéale qui joint le dessin au confort.  
 Repose fer réversible pour gaucher

## Practical style!

**What size** Board size: 122 x 40 cm  
**Category** Bottom frame made of painted steel tube.  
 Iron rest made of painted sheet metal.  
 100% cotton ironing board cover with felt pad  
**Why** The perfect combination of design and practicality.  
 Reversible iron rest holder for left-handed

## ¡Estilo y practicidad!

**Cuánto** Dimensiones del tablero de red expandida 122 x 40 cm  
**Categoría** Estructura inferior en tubo de acero pintado. Reposa-plancha en chapa pintada.  
 Funda de algodón 100% con muletón para tablas de planchar  
**Porqué** La solución perfecta que reúne diseño y comodidad.  
 Soporte para la plancha reversible para zurdos



Item	Gimi	Ean	Ø	1 pz	axbxc=cm	axbxc=cm	axbxc=cm	n° pz	n° pz	h=cm	n° pz
Uniko	14830343	8001244009035	32x18 mm	7,60	122x38x90	38x7x152,5	39,5x15x154	2	30	169	21



Item	Gimi	Ean	Ø	1 pz	axbxc=cm	axbxc=cm	axbxc=cm	n° pz	n° pz	h=cm	n° pz
Temper	14770514	8001244008991	22 mm 32 mm	6,60	122x40x90	40x7x154,5	41,5x27x157	4	36	172	22



# Poker

Drop Line



## Completo di tutto per stirare al meglio!

**Quanto** Piano rete dimensioni 122x40 cm  
**Categoria** Telaio inferiore in tubo di acciaio verniciato a sezione ovale.  
 Poggiaferro/portacaldaia in lamiera verniciata.  
 Foderina 100% cotone con mollettone  
**Perché** Splendido design e cura dei particolari; dotato di griglia portapani estraibile lateralmente.  
 Piastra poggiaferro reversibile per mancini

## Comes with everything you need!

**What size** Board size: 122 x 40 cm  
**Category** Bottom frame made of painted steel tube, oval section.  
 Iron/boiler rest made of painted steel.  
 100% cotton ironing board cover with felt pad  
**Why** Splendid design and meticulous attention to detail; fitted with clothes rack that can be pulled out from the side.  
 Reversible iron rest plate for left-handed

## Komplett ausgestattet für besseres Bügeln!

**Maße** Auflagefläche 122 cm x 40 cm  
**Material** Untergestell aus lackiertem Stahlrohr, rechtwinkliger Querschnitt.  
 Bügeleisenhalterung/Halterung für Wassertank von Bügelstationen aus lackiertem Stahl.  
 Bügeltischbezug aus 100% Baumwolle mit Moltonunterseite  
**Merkmale** Eindrucksvolles Design und sorgfältige Ausführung der Details; ausgestattet mit einem seitlich angebrachten, abnehmbaren Wäschehalter.  
 Bügeleisenstandfläche, für Linkshänder verstellbar



## Elle est équipée de tout ce qui vous permettra de repasser parfaitement!

**Taille** Plateau 122 x 40 cm  
**Matériaux** Structure inférieure en tube d'acier peint en section ovale.  
 Repose-fer en acier peint pour centrale vapeur.  
 Housse en coton 100% avec molleton pour table à repasser  
**Avantages** Design magnifique et détails soignés. Elle est pourvue de grille porte-vêtements amovible latéralement.  
 Repose fer réversible pour gaucher

## ¡Con todo lo necesario para planchar de la mejor manera!

**Cuánto** Dimensiones del tablero de red expandida 122 x 40 cm  
**Categoría** Estructura inferior en tubo de acero pintado de sección oval. Soporte especial en acero pintado para calderas de vapor.  
 Funda de algodón 100% con muletón para tablas de planchar  
**Porqué** Espléndido diseño y cuidado de los detalles; equipada con rejilla para apoyar la ropa extraíble lateralmente.  
 Reposaplanchas reversible para zurdos



# Golden

Drop Line



## Il piano di stiratura più ampio in assoluto!

**Quanto** Piano rete dimensioni 126x45 cm  
**Categoria** Telaio inferiore in tubo di acciaio verniciato a sezione rettangolare.  
 Poggiaferro/portacaldaia in lamiera verniciata.  
 Foderina 100% cotone con mollettone  
**Perché** Molto comodo, molto stabile, completo di griglia inferiore portabiancheria.  
 Archetto poggiaferro reversibile per mancini

## The largest ironing board of them all!

**What size** Board size: 126 x 45 cm  
**Category** Bottom frame made of painted steel tube, rectangular section.  
 Iron/boiler rest made of painted steel.  
 100% cotton ironing board cover with felt pad  
**Why** Very practical, very stable, complete with bottom clothes rack.  
 Reversible iron rest holder for left-handed

## Die absolut größte Bügelfläche!

**Maße** Auflagefläche 126 cm x 45 cm  
**Material** Untergestell aus lackiertem Stahlrohr, rechtwinkliger Querschnitt.  
 Bügeleisenhalterung/Halterung für Wassertank von Bügelstationen aus lackiertem Stahl.  
 Bügeltischbezug aus 100% Baumwolle mit Moltonunterseite  
**Merkmale** Sehr bequem, sehr stabil, mit einem unteren Gitter als Wäscheablage.  
 Bügeleisenhalter, für Linkshänder verstellbar

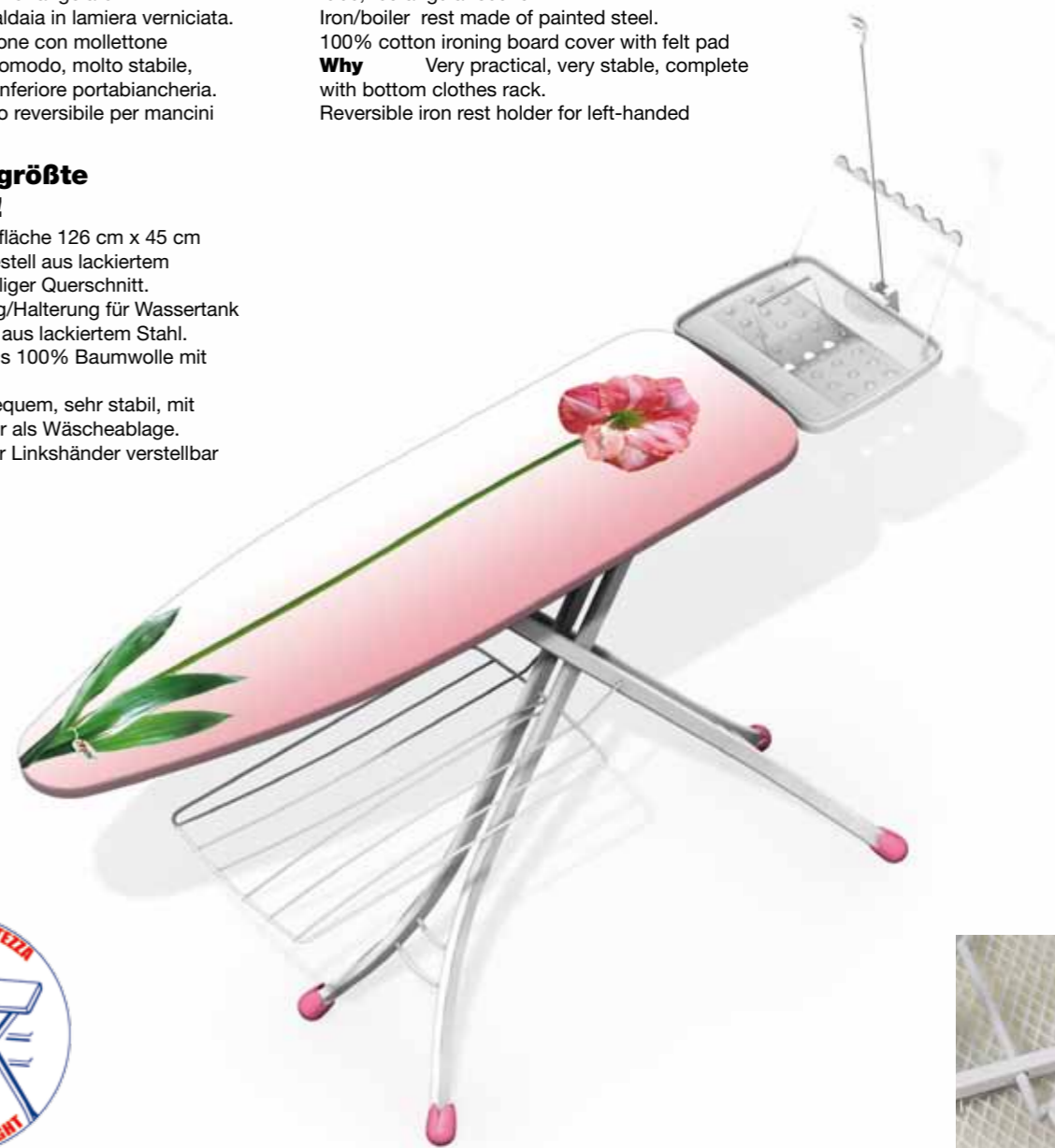

## La planche à repasser la plus grande en absolu!

**Taille** Plateau 126 x 45 cm  
**Matériaux** Structure inférieure en tube d'acier peint en section rectangulaire. Repose-fer en acier peint pour centrale vapeur.  
 Housse en coton 100% avec molleton pour table à repasser  
**Avantages** Très confortable, extrêmement stable. Elle est pourvue d'une grille repose-linge.  
 Repose fer réversible pour gaucher

## ¡¡La tabla de planchar más amplia en absoluto!

**Cuánto** Dimensiones del tablero de red expandida 126x45 cm  
**Categoría** Estructura inferior en tubo de acero pintado de sección rectangular, soporte especial en acero pintado para calderas de vapor. Funda de algodón 100% con muletón para tablas de planchar  
**Porqué** Muy cómoda y muy estable, con rejilla inferior para apoyar la ropa incluida.  
 Soporte para la plancha reversible para zurdos

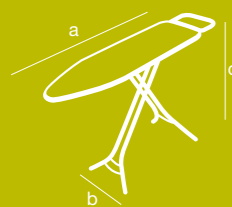
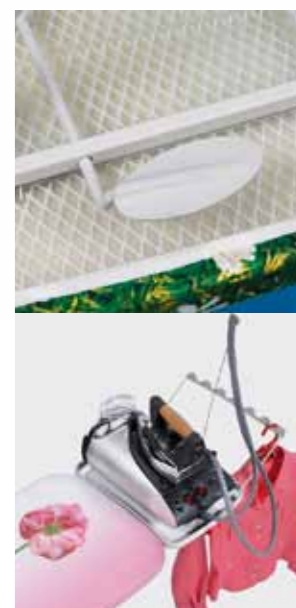

Item	Gimi	Ean	35x20 mm 60x20 mm	1 pz	Aperto Open	Chiuso Folded	axbxc=cm	n° pz	n° pz	h=cm	n° pz
Poker	14630413	8001244009073	35x20 mm 60x20 mm	8,05	122x40x90	40x7,5x157,5	41x16x157	2	26	172	19

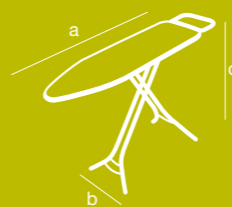

Item	Gimi	Ean	30x20 mm	1 pz	Aperto Open	Chiuso Folded	axbxc=cm	axbxc=cm	axbxc=cm	n° pz	n° pz	h=cm	n° pz
Golden	14270365	8001244008953	30x20 mm	8,30	126x45x90	45x6,5x160	46x15,5x161	2	26	176	17		



## Rifiniture curatissime, dotazione completa!

**Quanto** Piano rete dimensioni 126 x 45 cm  
**Categoria** Telaio inferiore in tubo di acciaio verniciato a sezione rettangolare.  
 Poggiaferro/portacaldaia in lamiera verniciata.  
 Foderina 100% cotone con mollettone  
**Perché** Estetica al top e grandi dimensioni; dotato di portacaldaia e di griglia portapanni estraibile lateralmente.  
 Archetto poggiaferro reversibile per mancini

## Meticulously detailed finish, fully equipped!!

**What size** Board size: 126 x 45 cm  
**Category** Bottom frame made of painted steel tube, rectangular section.  
 Iron/boiler rest made of painted steel.  
 100% cotton ironing board cover with felt pad  
**Why** Excellent appearance and large size; fitted with boiler support and clothes rack that can be pulled out from the side.  
 Reversible iron rest holder for left-handed

## Sorgfältige Endfertigung, komplette Ausstattung!

**Maße** Auflagefläche 126 cm x 45 cm  
**Material** Untergestell aus lackiertem Stahlrohr, rechtwinkliger Querschnitt.  
 Bügeleisenhalterung/Halterung für Wassertank von Bügelstationen aus lackiertem Stahl.  
 Bügeltischbezug aus 100% Baumwolle mit Moltonunterseite  
**Merkmale** Top-Ästhetik und große Arbeitsfläche. Ausgestattet mit Boilerhalterung und einer seitlichen, abnehmbaren Wäscheablage.  
 Bügeleisenhalter, für Linkshänder verstellbar

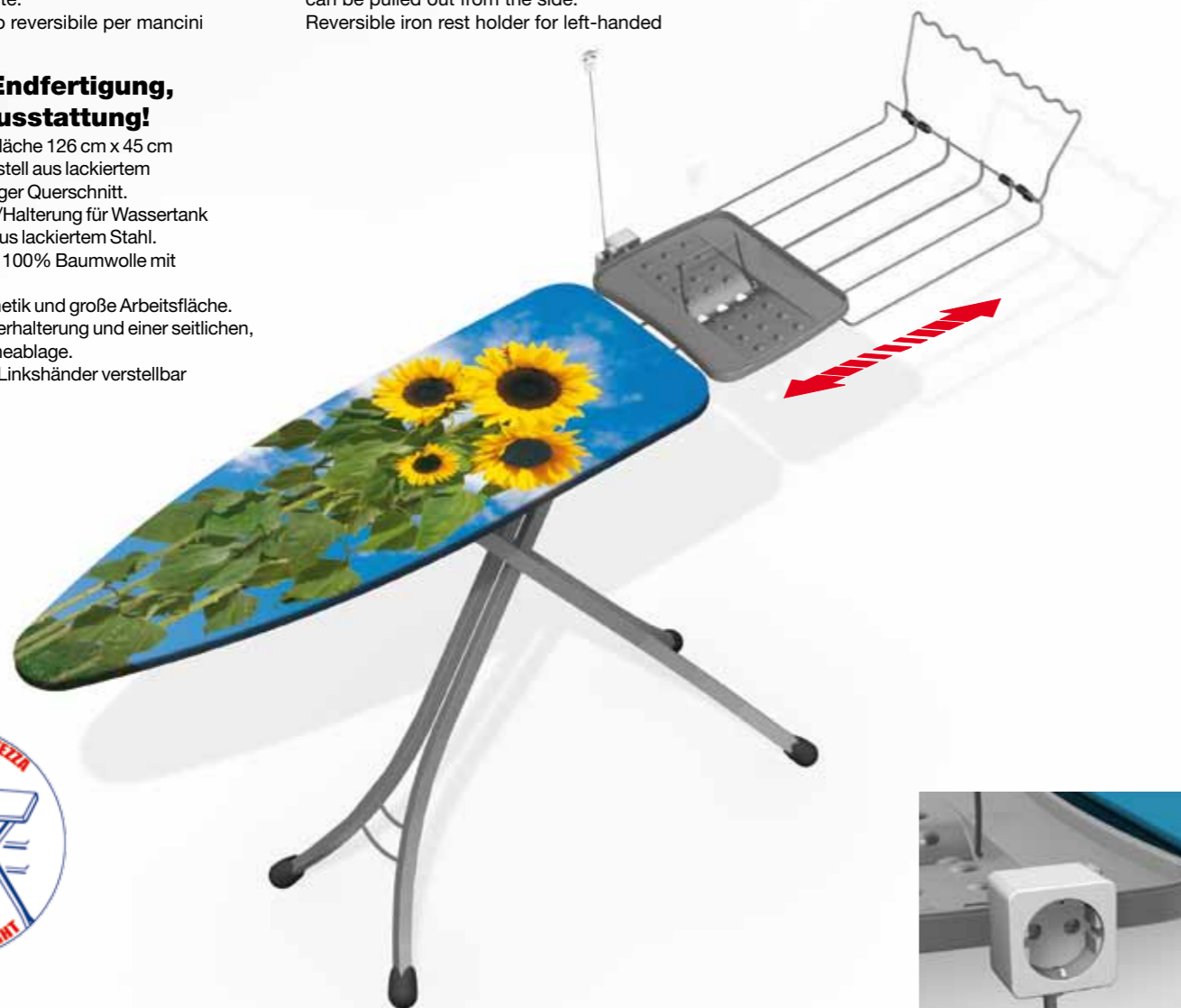

## Finitions extrêmement soignées, avec tous les accessoires!

**Taille** Plateau 126 x 45 cm  
**Matériaux** Structure inférieure en tube d'acier peint en section rectangulaire. Repose-fer en acier peint pour centrale vapeur. Housse en coton 100% avec molleton pour table à repasser  
**Avantages** Une grande esthétique avec de grandes dimensions. Elle est pourvue de repose-fer traditionnel et centrale à vapeur et de grille repose-linge amovible latéralement.  
 Repose fer réversible pour gaucher

## ¡Acabados perfectos y equipamiento completo!

**Cuánto** Dimensiones del tablero de red expandida 126x45 cm  
**Categoría** Estructura inferior en tubo de acero pintado de sección rectangular. Soporte especial en acero pintado para calderas de vapor. Funda de algodón 100% con muletón para tablas de planchar  
**Porqué** El máximo de la estética y grandes dimensiones; equipada con portacaldera y rejilla para apoyar la ropa extraíble lateralmente. Soporte para la plancha reversible para zurdos



## Più spazio alla comodità!

**Quanto** Piano rete dimensioni 126 x 48 cm  
**Categoria** Telaio inferiore in tubo di acciaio verniciato a sezione ovale.  
 Poggiaferro/portacaldaia in lamiera verniciata.  
 Foderina 100% cotone con mollettone  
**Perché** Dotato di griglia portapanni estraibile lateralmente, permette di stirare con grande comodità.  
 Piastra poggiaferro reversibile per mancini

## More functional space!

**What size** Board size: 126 x 48 cm  
**Category** Bottom frame made of painted steel tube, oval section.  
 Iron/boiler rest made of painted steel.  
 100% cotton ironing board cover with felt pad  
**Why** Fitted with clothes rack that can be pulled out from the side, ironing has never been more practical.  
 Reversible iron rest plate for left-handed

## Mehr Platz für mehr Komfort!

**Maße** Auflagefläche 126 cm x 48 cm  
**Material** Untergestell aus lackiertem Stahlrohr mit ovalem Schnitt.  
 Bügeleisenhalterung/Halterung für Wassertank von Bügelstationen aus lackiertem Stahl.  
 Bügeltischbezug aus 100% Baumwolle mit Moltonunterseite  
**Merkmale** Die Ausstattung mit einem seitlich angebrachten, abnehmbaren Wäschehalter erlaubt das Bügeln mit großem Komfort.  
 Bügeleisenstandfläche, für Linkshänder verstellbar

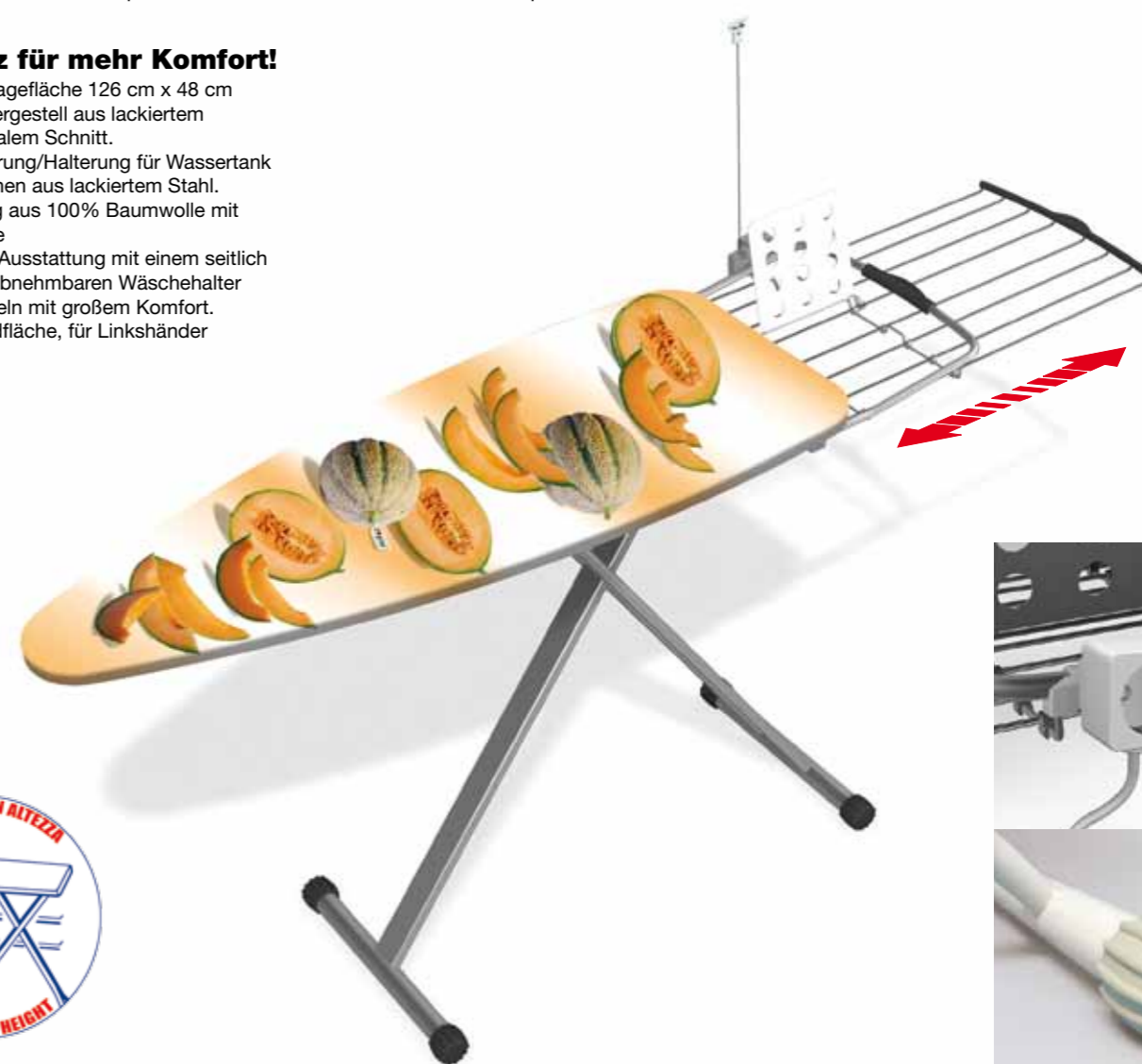

## Plus d'espace pour le confort!

**Taille** Plateau 126 x 48 cm  
**Matériaux** Structure inférieure en tube d'acier peint en section ovale.  
 Repose-fer en acier peint pour centrale vapeur.  
 Housse en coton 100% avec molleton pour table à repasser  
**Avantages** Elle est pourvue de grille repose-linge amovible latéralement, pour un repassage très confortable.  
 Repose fer réversible pour gaucher

## ¡Más espacio a la comodidad!

**Cuánto** Dimensiones del tablero de red expandida 126 x 48 cm  
**Categoría** Estructura inferior en tubo de acero pintado (diám. 28 mm y 35 mm) de sección oval, soporte especial en acero pintado para calderas de vapor. Funda de algodón 100% con muletón para tablas de planchar  
**Porqué** Equipada con rejilla para apoyar la ropa extraíble lateralmente, permite planchar con gran comodidad. Reposaplanchas reversible para zurdos

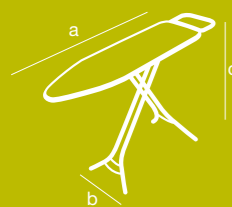

Item	Gimi	Ean	1 pz	axbxc=cm	axbxc=cm	axbxc=cm	n° pz	n° pz	h=cm	n° pz	
Mitiko	14500783	8001244009059	30x20 mm	8,55	126x45x90	45x6,5x160	47x15x163	2	26	178	17

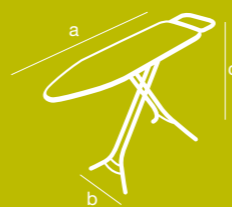

Item	Gimi	Ean	1 pz	axbxc=cm	axbxc=cm	axbxc=cm	n° pz	n° pz	h=cm	n° pz	
Prisma	14630353	8001244009097	35x20 mm 60x20 mm	9,20	126x48x90	48x7,5x163,5	49x16x158	2	22	173	16

# Assi da stiro Advance Line Advance 100



## Benvenute lenzuola! Un'idea geniale ma semplice suggerita dalle consumatrici!

Una funzione innovativa per stirare agevolmente lenzuola e tovaglie senza che tocchino terra: una prolunga estraibile, bloccata da due rondelle, permette di distendere la stoffa da stirare o già stirata senza ricorrere ad appoggi impropri quali un tavolo o una sedia. Grazie a questo dispositivo esclusivo, all'elegante finitura silver e alle nuove raffinate foderine la linea Advance si distingue ulteriormente all'interno di una gamma che già rappresenta il punto di riferimento sul mercato.

## Endlich auch für Betttücher! Eine geniale, aber einfache Idee, die von unseren Verbraucherinnen kommt!

Eine innovative Funktion um problemlos Betttücher und Tischdecken zu bügeln, ohne dass sie den Boden berühren. Eine herausnehmbare Verlängerung, die durch zwei Scheiben verriegelt werden kann und es gestattet, den zu bügelnden oder gebügelten Stoff auszubreiten, ohne dass man Tisch oder Stuhl zur Hilfe ziehen muss. Dank dieser exklusiven Vorrichtung, der eleganten Silver-Fertigung und den neuen raffinierten Bezügen, sticht die Serie Advance umso mehr aus einem Sortiment hervor, das selbst schon ein Bezugspunkt auf dem Markt ist.

## Sheets are welcome! An ingenious but simple idea suggested by our users!

An innovative function for easy ironing of sheets and tablecloths without letting them touch the floor: a pull-out extension, blocked by two rollers, allows you to spread out the fabric to be ironed or already ironed without resorting to improvised supports such as a table or chair. Thanks to this exclusive device, the elegant silver finish and the fine new ironing board covers, the Advance line is particularly distinguished within a range that is already a point of reference on the market.

## Les draps sont bienvenus! Une idée à la fois géniale et simple suggérée par les consommatrices!

Une fonction révolutionnaire pour le repassage aisée des draps et des nappes sans qu'ils touchent le sol: une rallonge escamotable, bloquée par deux rondelles, où étendre le linge à repasser ou déjà repassé sans avoir recours à des solutions inappropriées telles qu'une table ou une chaise. Grâce à ce dispositif exclusif, à son élégante finition argent et aux nouvelles housses raffinées, la ligne Advance se distingue encore mieux à l'intérieur d'une gamme qui est déjà le point de repère sur le marché.

## ¡Bienvenidas sábanas! ¡Una idea genial, sugerida por nuestras clientes!

Una función innovadora para planchar fácilmente sábanas y manteles sin tocar el suelo: una extensión extraíble, bloqueada por dos arandelas, permite desplegar el tejido a planchar o ya planchado, sin recurrir a apoyos inapropiados como mesas o sillas. Gracias a este exclusivo dispositivo, al elegante revestimiento gris plata y a las nuevas y renovadas fundas, la línea Advance se distingue aún más dentro de una línea que ya representa una referencia en el mercado.

**Quanto** Piano rete dimensioni **122 x 38 cm**  
**Categoria** Telaio inferiore in tubo di acciaio verniciato.

Poggiaferro in lamiera verniciata.

Foderina 100% cotone con mollettone

**Perché** per stirare comodamente capi di ogni dimensione; completo di griglia inferiore portabiancheria.

Archetto poggiaferro reversibile per mancini

Esclusivo sistema reggilenzuola estraibile (estensione cm 37)

**What size** Board size: **122 x 38 cm**

**Category** Bottom frame made of painted steel tube.

Iron rest made of painted sheet metal.

100% cotton ironing board cover with felt pad

**Why** To easily iron garments of any size; complete with bottom clothes rack.

Reversible iron rest holder for left-handed.

Exclusive sheet-holder system that can be pulled out (extension cm 37)



GIMI  
EXCLUSIVE

**Maße** Auflagefläche **122 cm x 38 cm**

**Material** Untergestell aus lackiertem Stahlrohr. Bügeleisenhalterung aus lackiertem Blech. Bügeltischbezug aus 100% Baumwolle mit Moltonunterseite

**Merkmale** Zum komfortablen Bügeln von Kleidungsstücken jeder Größe; mit einem unteren Gitter zur Wäscheablage. Bügeleisenhalter, für Linkshänder verstellbar. Exklusives Betttuch-Haltesystem (ausziehbar auf 37 cm)

**Taille** Plateau **122 x 38 cm**  
**Matériaux** Structure inférieure en tube d'acier peint. Repose-fer en tôle vernie. Housse en coton 100% avec molleton pour table à repasser

**Avantages** Pour repasser de manière confortable tout vêtement de n'importe quelle dimension. Elle est pourvue d'une grille reposelinge. Repose fer réversible pour gaucher. Système extractible exclusif pour draps (longueur cm 37)

**Cuánto** Dimensiones del tablero de red expandida **122 x 38 cm**  
**Categoría** bastidor inferior en tubo de acero pintado. Reposa-plancha en chapa pintada. Funda de algodón 100% con muletón para tablas de planchar

**Porqué** para planchar cómodamente prendas de diferentes tamaños; con rejilla inferior para apoyar la ropa incluida. Soporte para la plancha reversible para zurdos. Exclusivo sistema extraíble para apoyar las sábanas (extensión cm 37)

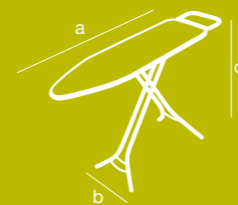

Aperto  
Open

Chiuso  
Folded



Item	Gimi	Ean	Ø	1 pz	axbxc=cm	axbxc=cm	axbxc=cm	n° pz	n° pz	h=cm	n° pz
Advance 100	14630345	8001244011090	22 mm	6,70	122x38x90	38x7,5x153	40,5x29,5x155	4	28	170	21

# Advance 120

**Quanto** Piano rete dimensioni **122 x 38 cm**  
**Categoria Telaio inferiore in tubo di acciaio verniciato a sezione ovale.**

Poggiaferro in lamiera verniciata.  
 Foderina 100% cotone con mollettone  
**Perché** curato in ogni particolare e completo di griglia inferiore portabiancheria.  
 Archetto poggiaferro reversibile per mancini  
 Esclusivo sistema reggilenzuola estraibile (estensione cm 37)

**What size** Board size: **122 x 38 cm**  
**Category** **Bottom frame made of painted steel tube, oval section.**

Iron rest made of painted sheet metal.  
 100% cotton ironing board cover with felt pad  
**Why** Meticulous attention to detail, comes with bottom clothes rack.  
 Reversible iron rest holder for left-handed.  
 Exclusive sheet-holder system that can be pulled out (extension cm 37)

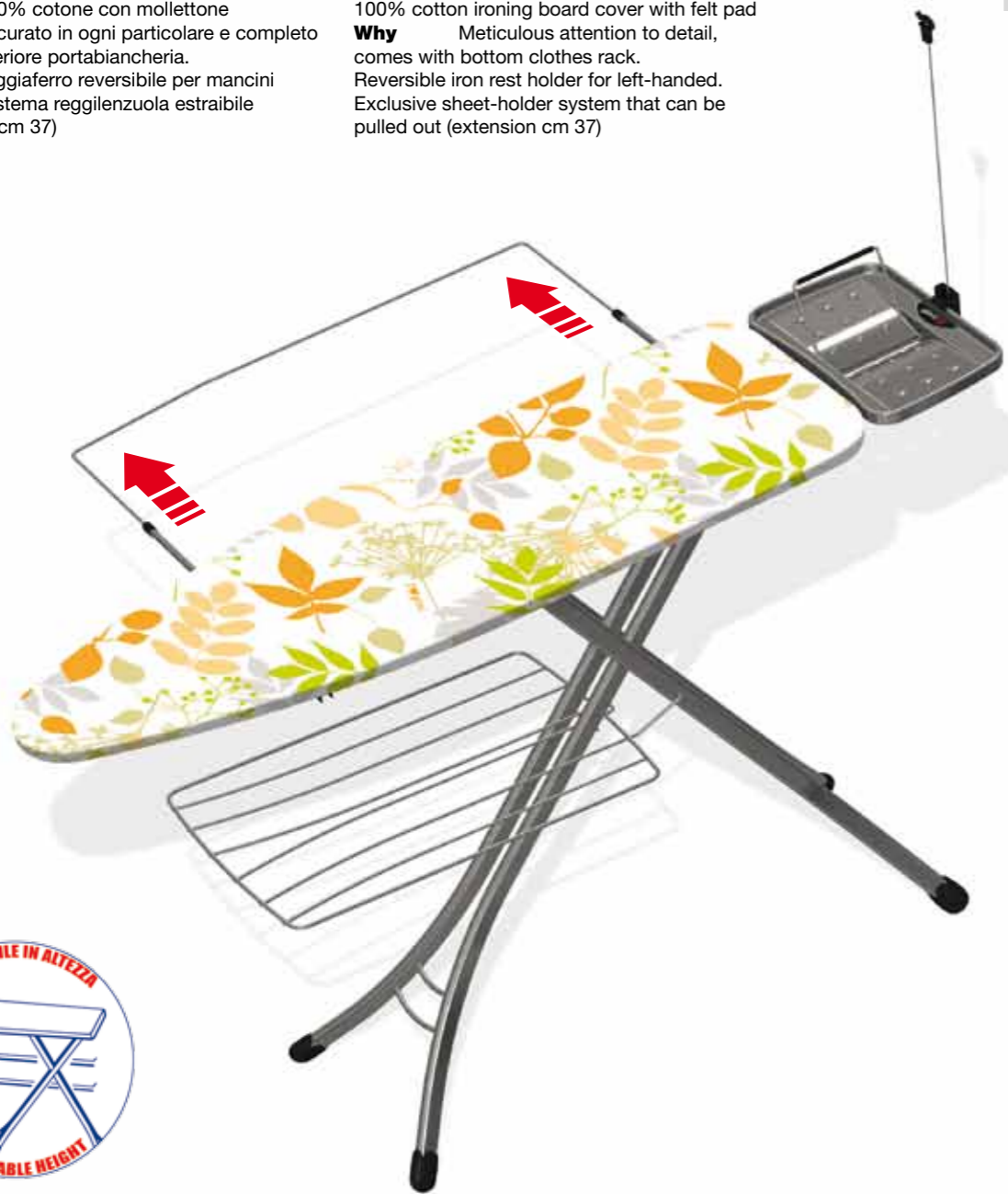

GIMI EXCLUSIVE

**Maße** Auflagefläche **122 cm x 38 cm**  
**Material** **Untergestell aus lackiertem Stahlrohr mit ovalem Querschnitt.**  
 Bügeleisenhalterung aus lackiertem Blech.  
 Bügeltischbezug aus 100% Baumwolle mit Moltonunterseite  
**Merkmale** Größte Widerstandsfähigkeit und auch nach Jahren unverändertes Aussehen. Mit einem unteren Gitter zur Wäscheablage.  
 Bügeleisenhalter, für Linkshänder verstellbar.  
 Exklusives Bettuch-Haltesystem (ausziehbar auf 37 cm)

**Taille** Plateau **122 x 38 cm**  
**Matériaux** **Structure inférieure en tube d'acier peint en section ovale.**  
 Repose-fer en tôle vernie.  
 Housse en coton 100% avec molleton pour table à repasser  
**Avantages** Détails soignés. Elle est pourvue d'une grille repose-linge.  
 Repose fer réversible pour gaucher.  
 Système extractible exclusif pour draps (longueur cm 37)

**Cuánto** Dimensiones del tablero de red expandida **122 x 38 cm**  
**Categoría** **Estructura inferior en tubo de acero pintado de sección oval.** Reposaplancha en chapa pintada. Funda de algodón 100% con muletón para tablas de planchar  
**Porqué** Cuidada en cada uno de sus detalles y con rejilla inferior para apoyar la ropa incluida. Soporte para la plancha reversible para zurdos. Exclusivo sistema extraíble para apoyar las sábanas (extension cm 37)



Item	Gimi	Ean		1 pz	axbxc=cm	axbxc=cm	axbxc=cm	n° pz	n° pz	h=cm	n° pz
Advance 120	14170370	8001244011113		1	122x38x90	38x9x152,5	19x39,5x155	2	24	170	17

# Advance 140

**Quanto** Piano rete dimensioni **126 x 45 cm**  
**Categoria Telaio inferiore in tubo di acciaio verniciato a sezione rettangolare.**

Poggiaferro/portacaldaia in lamiera verniciata.  
 Foderina 100% cotone con mollettone  
**Perché** Molto comodo, molto stabile, completo di griglia inferiore portabiancheria.  
 Archetto poggiaferro reversibile per mancini  
 Esclusivo sistema reggilenzuola estraibile (estensione cm 39)

**What size** Board size: **126 x 45 cm**  
**Category** **Bottom frame made of painted steel tube, rectangular section.**

Iron/boiler rest made of painted steel.  
 100% cotton ironing board cover with felt pad  
**Why** Very practical, very stable, complete with bottom clothes rack.  
 Reversible iron rest holder for left-handed.  
 Exclusive sheet-holder system that can be pulled out (extension cm 39)

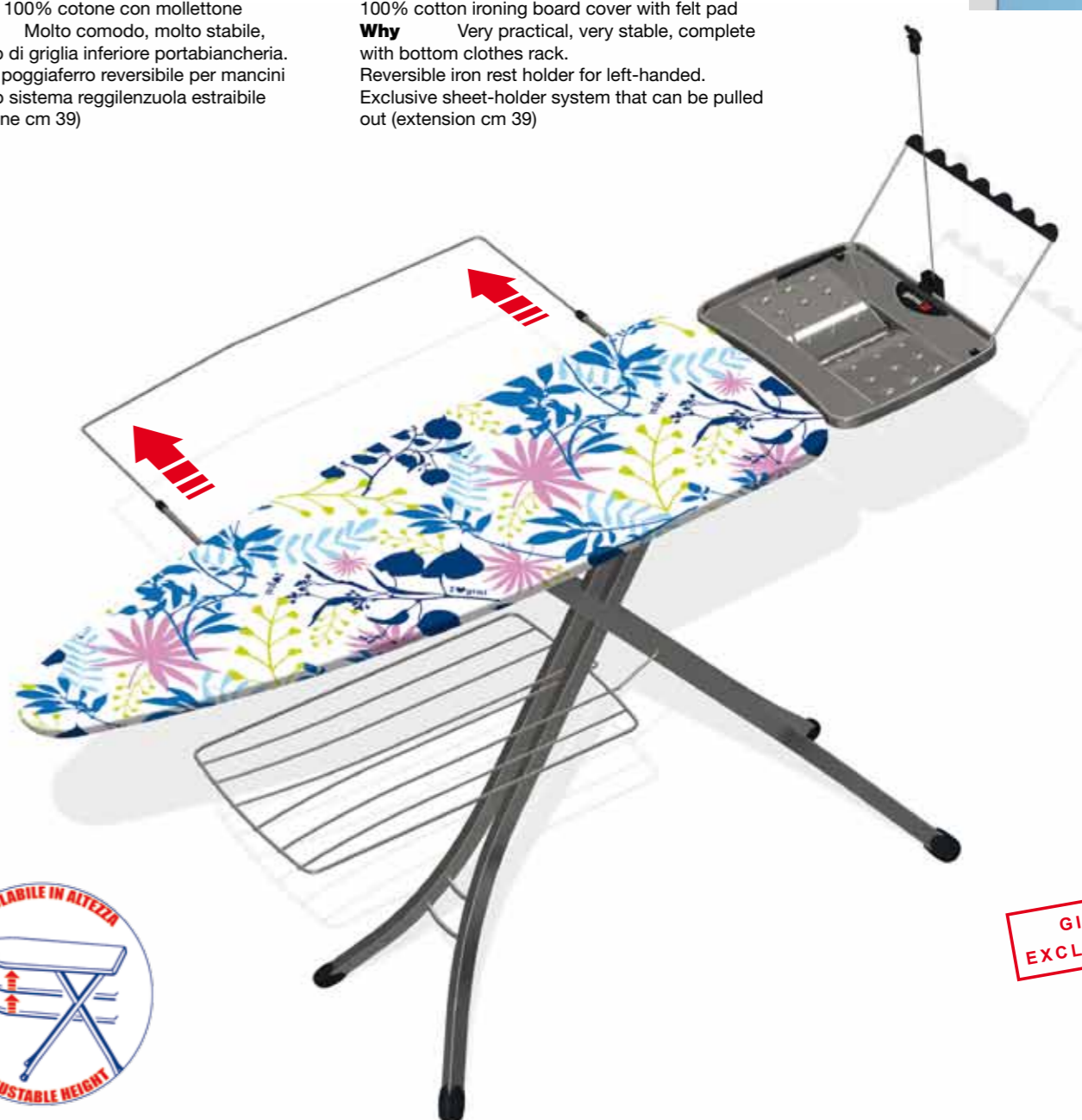

GIMI EXCLUSIVE

**Maße** Auflagefläche **126 cm x 45 cm**  
**Material** **Untergestell aus lackiertem Stahlrohr, rechtwinkliger Querschnitt.**  
 Bügeleisenhalterung/Halterung für Wassertank von Bügelstationen aus lackiertem Stahl.  
 Bügeltischbezug aus 100% Baumwolle mit Moltonunterseite  
**Merkmale** Sehr bequem, sehr stabil, mit einem unteren Gitter als Wäscheablage.  
 Bügeleisenhalter, für Linkshänder verstellbar.  
 Exklusives Bettuch-Haltesystem (ausziehbar auf 39 cm)

**Taille** Plateau **126 x 45 cm**  
**Matériaux** **Structure inférieure en tube d'acier peint en section rectangulaire.**  
 Repose-fer en acier peint pour centrale vapeur.  
 Housse en coton 100% avec molleton pour table à repasser  
**Avantages** Très confortable, extrêmement stable. Elle est pourvue d'une grille repose-linge.  
 Repose fer réversible pour gaucher.  
 Système extractible exclusif pour draps (longueur cm 39)

**Cuánto** Dimensiones del tablero de red expandida **126 x 45 cm**  
**Categoría** **Estructura inferior en tubo de acero pintado de sección rectangular,** soporte especial en acero pintado para calderas de vapor. Funda de algodón 100% con muletón para tablas de planchar  
**Porqué** Muy cómoda y muy estable, con rejilla inferior para apoyar la ropa incluida. Soporte para la plancha reversible para zurdos. Exclusivo sistema extraíble para apoyar las sábanas (extension cm 39)



Item	Gimi	Ean		1 pz	axbxc=cm	axbxc=cm	axbxc=cm	n° pz	n° pz	h=cm	n° pz
Advance 140	14270367	8001244011137		1	126x45x90	45x10x160	46x19,5x162	2	20	177	13

# Accessori per stirare

# King Aluminium e Joker

Categoria Category	Nome prodotto Item	100% Cotone 100% cotton	Mollettone Felt pad	Spugna Foam	Altro Other
Foderina per asse da stiro Ironing board cover	King Aluminium	✓		✓	
Mollettone Felt pad	Joker		✓		
Foderina per asse da stiro Ironing board cover	I Love Gimi	✓	✓		
	Stiro Strong	✓	✓		spalmatura in titanio titanium coating
	Stiro Fast	✓	✓		spalmatura in perlato pearl coating
	Stiro Soft	✓	✓	✓	
	Stiro Top	✓	✓		tessuto jacquard jacquard fabric mollettone rinforzato reinforced felt pad
Telo da stiro per tavolo Ironing blanket	Wrappy	✓	✓		

Categoria Category	Nome prodotto Item	Foderina Ironing board cover	Piano rete Board length
Stiramaniche Sleeve board	Planet	100% cotone + mollettone 100% cotton + felt pad	52 cm



## King Aluminium

Foderina cotone alluminato con spugna  
Metallized cotton ironing board cover with foam  
Bügeltischbezug aus metallisiertem  
Baumwollgewebe mit Schaumstoffunterseite.  
Housse en coton aluminisé avec mousse pour  
table à repasser  
Funda de algodón metalizado con esponja para  
tablas de planchar

## Joker

Mollettone (gr 400/m2)  
Felt pad (gr 400/m2)  
Molton (gr 400/m2)  
Molleton (gr 400/m2)  
Muletón (gr 400/m2)

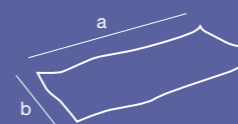

Item	Gimi	Ean	1 pz	axb-cm	axbc-cm	axb-cm	axbc-cm	n° pz	n° pz	h-cm	n° pz
King Aluminium "S"	12034311	8001244004047	0,11	120x43	25x2,5x39	max 110 x max 33	26,5x36,5x27	12	540	150	459
King Aluminium "M"	12034321	8001244004054	0,18	130x50	25x2,5x39	max 125 x max 40	26,5x36,5x27	12	540	150	459
King Aluminium "L"	12034331	8001244004061	0,20	136x58	25x2,5x39	max 130 x max 45	26,5x36,5x27	12	540	150	459
Joker	12033930	8001244003989	0,30	140x50	25x4x39	max 135 x max 45	26,5x36,5x51	12	216	117	243

Per descrizioni dettagliate consultare le pagine dei singoli prodotti.  
For more details please see the related product pages.

# I love gimi "S"



Foderina 100% cotone con mollettone  
 100% cotton ironing board cover with felt pad  
 Bügeltischbezug aus 100% Baumwolle mit Moltonunterseite  
 Housse en coton 100% avec molleton pour table à repasser  
 Funda de algodón 100% con muletón para tablas de planchar

## Deep Orange



Sunflowers



Juicy Lemon



Callas Forever

## Tea Rose



Butterfly

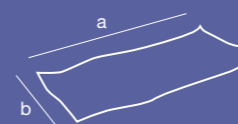

Item	Gimi	Ean	1 pz	axb=cm	axbxc=cm	axb=cm	axbxc=cm	n° pz	n° pz	h=cm	n° pz
I love gimi "S"	12030014	8001244008373	0,24	120x43	25x3x39	max 110 x max 33	36,5x26,5x27	12	540	150	459

Composizione scatola: 2 pz per ciascuno dei 6 soggetti

Carton: 2 pcs x 6 designs

# I love gimi "M"



Foderina 100% cotone con mollettone  
 100% cotton ironing board cover with felt pad  
 Bügeltischbezug aus 100% Baumwolle mit Moltonunterseite  
 Housse en coton 100% avec molleton pour table à repasser  
 Funda de algodón 100% con muletón para tablas de planchar

## Bamboo

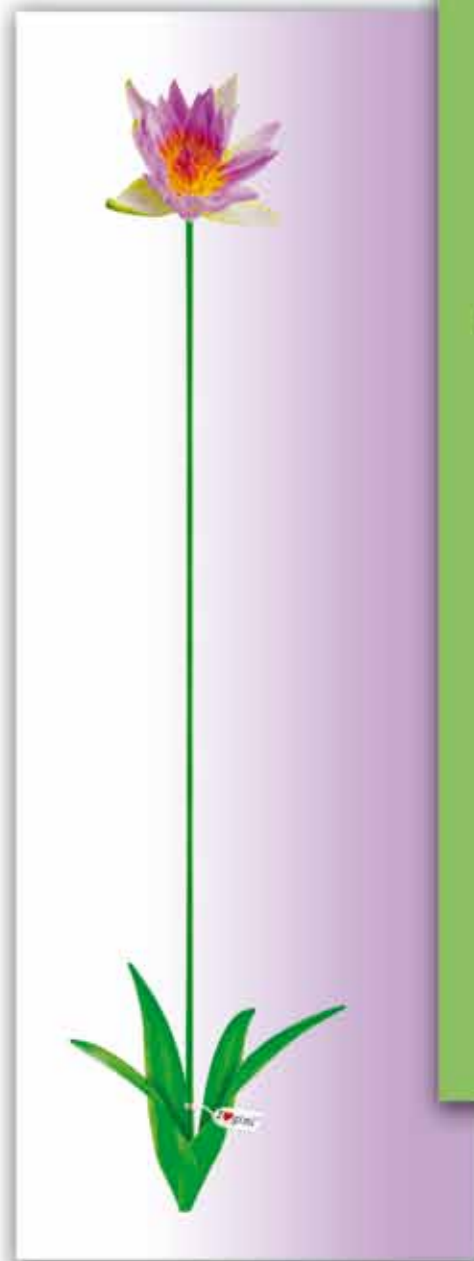

Royal Orchid



Sunflowers

## Sensational Kiwi



Wild Pineapple



Strawberries

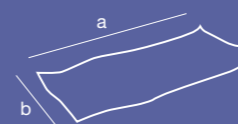

Item	Gimi	Ean	1 pz	axb=cm	axbxc=cm	axb=cm	axbxc=cm	n° pz	n° pz	n° pz	h=cm	n° pz
I love gimi "M"	12030024	8001244006683	0,28	132x48	25x3x39	max 125 x max 40	36,5x26,5x33,5	12	432	149		370

Composizione scatola: 2 pz per ciascuno dei 6 soggetti

Carton: 2 pcs x 6 designs

# I love gimi "L"



Foderina 100% cotone con mollettone  
 100% cotton ironing board cover with felt pad  
 Bügeltischbezug aus 100% Baumwolle mit Moltonunterseite  
 Housse en coton 100% avec molleton pour table à repasser  
 Funda de algodón 100% con muletón para tablas de planchar

**Watermelon**

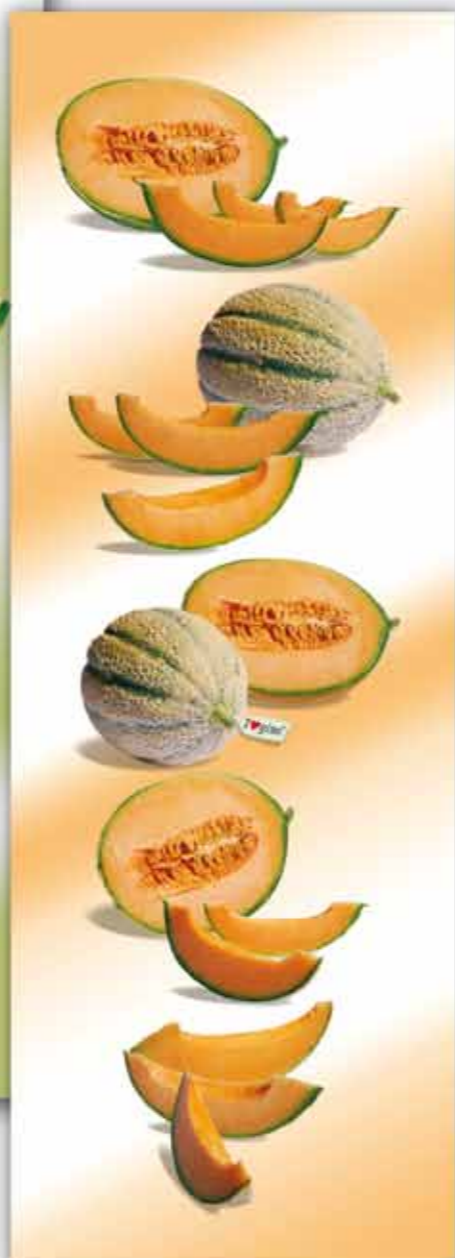

**Melon Seeds**



**Mediterranea**

**Red Tulip**



**Sunflowers**

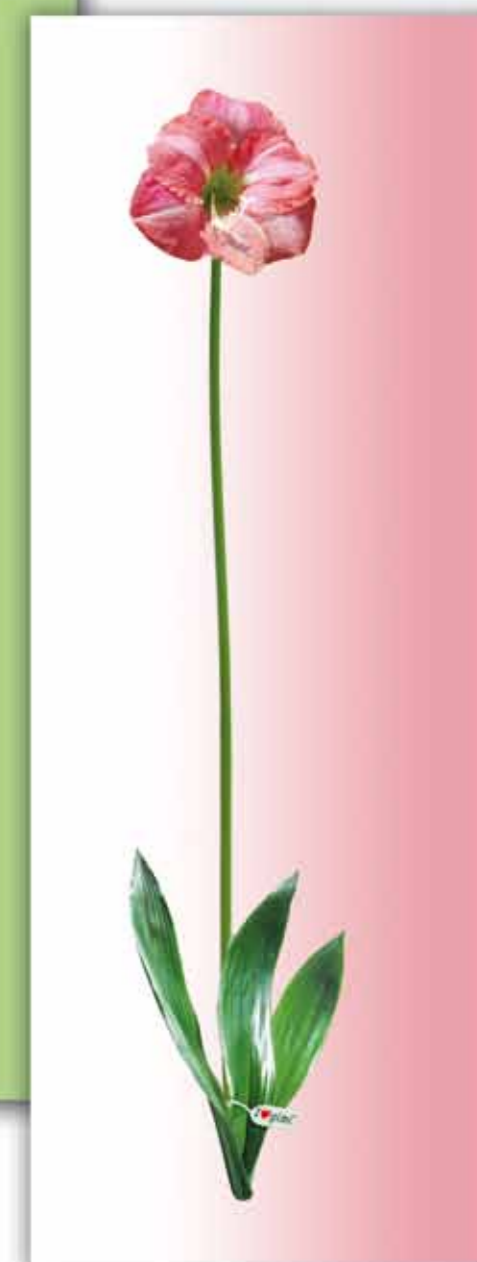

**Amarillo Dreams**

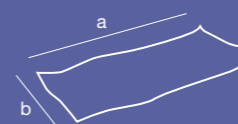

Item	Gimi	Ean	1 pz	axb=cm	axbxc=cm	axb=cm	axbxc=cm	n° pz	n° pz	h=cm	n° pz
I love gimi "L"	12030034	8001244006690	0,32	136x55	25x3x39	max 130 x max 45	36,5x26,5x36	12	432	159	344

Composizione scatola: 2 pz per ciascuno dei 6 soggetti

Carton: 2 pcs x 6 designs



# Foderine per stirare



Una gamma completa di foderine professionali, capaci di trasformare i gesti della stiratura in un'arte semplice ed insieme efficace.

A complete range of professional ironing board covers, to transform ironing into a simple yet effective art.

Ein vollständiges Sortiment an professionellen Bezügen, die das Bügeln in eine einfache und doch wirksame Kunst verwandeln.

Une gamme complète de housses professionnelles qui transforment les gestes du repassage en un art à la fois simple et efficace.

Una gama completa de fundas profesionales, capaces de transformar los movimientos del planchado en un arte sencillo y eficaz al mismo tiempo.

# Stiro Strong

## Titanio: durata garantita nel tempo!

Grazie al titanio questa foderina ha lunga durata, non ingiallisce né fa attaccare il ferro da stiro, una vita doppia rispetto ad una foderina comune.

Confezione con touch-patch di prova

## Titanium: guaranteed long life!

Thanks to titanium, this long-life cover does not turn yellow or stick to the iron: double the life of an ordinary cover.

Sample patch on the pack



## Titan: Garantiert langlebig!

Der Bezug besteht u.a. aus Titanium. Dadurch hat er eine lange Lebensdauer, vergilbt nicht und lässt das Bügeleisen nicht ankleben. Die Lebensdauer ist im Vergleich zu den gewöhnlichen Bezügen doppelt so lang. Verpackung mit einem Materialmuster zum Anfassen

## Titane: durée garantie dans le temps!

Grâce au titane, cette housse a une longue durée, ne jaunit pas et ne fait pas coller le fer à repasser; une durée double par rapport à une housse standard. Échantillon de tissu à l'extérieur du paquet

## Titanio: ¡Duración garantizada en el tiempo!

Gracias al titanio, esta funda dura muchísimo tiempo (el doble que cualquier funda común), no se amarillea ni se adhiere a la plancha. Presentación con muestra táctil de prueba

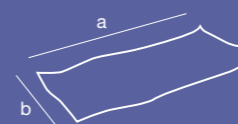

Item	Gimi	Ean	1 pz	Aperto Open		Chiuso Folded		n° pz	n° pz	h=cm	n° pz
				axb=cm	axb=cm	axb=cm	axbxc=cm				
Stiro strong "M"	12033000	8001244011250	0,30	130x50	25x3x39	max 122 x max 40	36,5x26,5x33,5	12	432	149	370
Stiro strong "L"	12033010	8001244011519	0,34	136x58	25x3x39	max 126 x max 48	36,5x26,5x36	12	432	159	344

# Stiro Fast

## Cotone perlato: risparmia energia e stira più veloce!

Il suo elevato potere termoriflettente, generato dallo speciale trattamento del tessuto, consente un significativo risparmio energetico, sia velocizzando i tempi di stiratura, sia consentendo un risultato impeccabile con una temperatura inferiore del ferro da stiro. Confezione con touch-patch di prova

## Heath- reflecting cotton: save energy and iron faster!

Its high heat-reflecting power, produced by the special treatment of the fabric, allows significant energy saving: it speeds up ironing times and allows an impeccable result with a lower iron temperature. Sample patch on the pack

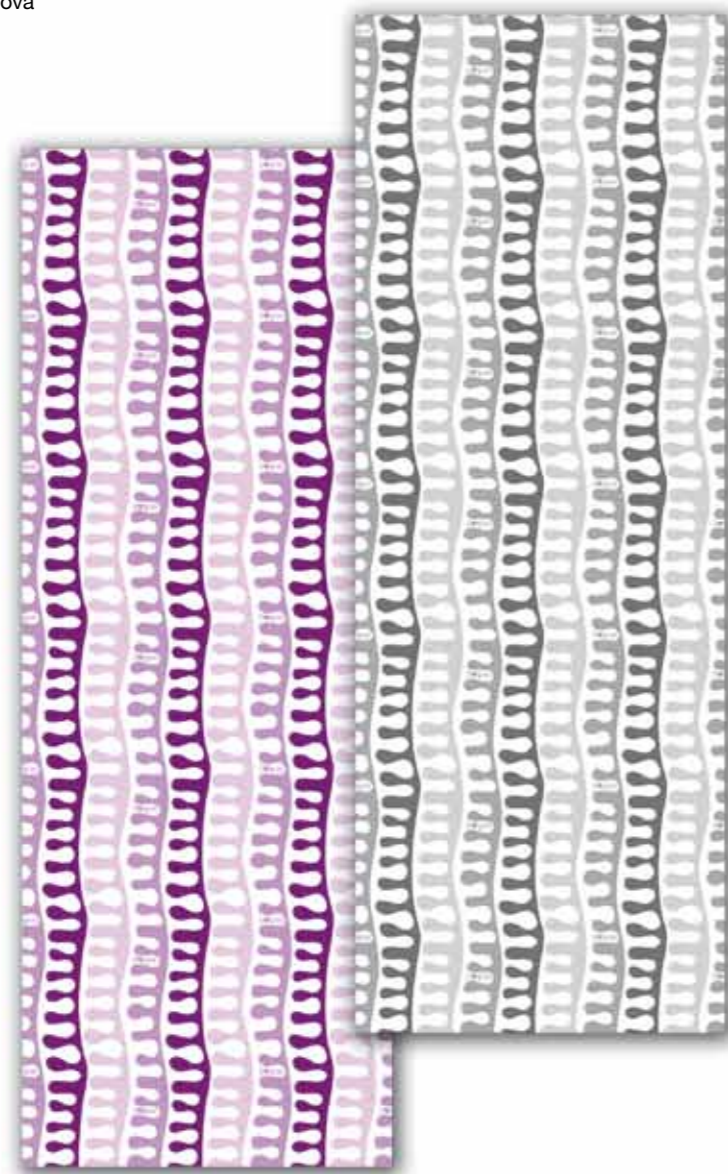

# Stiro Soft

## Triplo strato: stira sul morbido e col massimo comfort!

Grazie alla azione combinata di cotone, spugna e mollettone, la stiratura è meno faticosa e più facile: il ferro scorre più agilmente e il vapore in eccesso si assorbe efficacemente. Confezione con touch-patch di prova

## Triple layer: ironing on a soft surface with maximum comfort!

Thanks to the combined action of cotton, foam and felt padding, ironing is easier and less tiring: the iron slides more easily and the excess steam is efficiently absorbed. Sample patch on the pack



## Geperlte Baumwolle: Spart Energie und beschleunigt das Bügeln!

Das spezielle Gewebe – das einer besonderen Verarbeitung unterzogen wird – ist äußerst wärmerreflektierend, wodurch das Bügeln beschleunigt und gleichzeitig Energie gespart werden kann. Das Ergebnis ist auch bei niedrigen Temperaturen einwandfrei. Verpackung mit einem Materialmuster zum Anfassen

## Coton nacré: Économisez de l'énergie et repassez plus rapidement!

Le pouvoir thermoréfléchissant élevé obtenu grâce au traitement spécial du tissu assure une économie d'énergie importante car il rend le repassage plus rapide tout en garantissant un résultat impeccable avec une température du fer à repasser plus basse. Échantillon de tissu à l'extérieur du paquet

## Algodón perlado: ¡Ahorra energía y plancha más rápido!

Su elevado poder termorefllector, generado por el tratamiento especial del tejido, permite un notable ahorro de energía, ya sea agilizando el tiempo de planchado, que permitiendo un resultado impecable con una temperatura menos elevada de la plancha. Presentación con muestra táctil de prueba

## Dreifach-Schicht: Auf einer weichen Fläche bequem bügeln!

Das Bügeln wird durch den dreischichtigen Bezug aus Baumwolle, Schwamm und Molton erheblich erleichtert: Das Bügeleisen gleitet geschickt und der überschüssige Dampf wird wirksam aufgenommen. Verpackung mit einem Materialmuster zum Anfassen

## Triple couche: repassez sur une housse souple et exceptionnellement confortable!

Grâce à l'action conjuguée du coton, de l'éponge et du molleton, le repassage est moins fatigant et plus simple : le fer à repasser glisse plus aisément et tout excès de vapeur est efficacement absorbé. Échantillon de tissu à l'extérieur du paquet

## Triple capa: ¡Plancha sobre lo blando y con el máximo confort!

Gracias a la combinación de algodón, esponja y muletón, el planchado cansa menos y es más fácil: la plancha se desliza con más agilidad y absorbe con eficacia el exceso de vapor. Presentación con muestra táctil de prueba



Aperto  
Open

Chiuso  
Folded

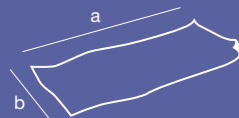

Item	Gimi	Ean	1 pz	axb=cm	axb=cm	axb=cm	axb=cm	axbxc=cm	n° pz	n° pz	h=cm	n° pz
Stiro fast "M"	12023000	8001244011236	0,28	130x50	25x3x39	max 122 x max 40	36,5x26,5x33,5	12	432	149	370	
Stiro fast "L"	12023010	8001244011533	0,32	136x58	25x3x39	max 126 x max 48	36,5x26,5x36	12	432	159	344	



Aperto  
Open

Chiuso  
Folded

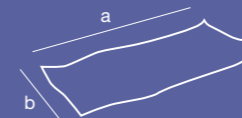

Item	Gimi	Ean	1 pz	axb=cm	axb=cm	axb=cm	axb=cm	axbxc=cm	n° pz	n° pz	h=cm	n° pz
Stiro soft "M"	12043000	8001244011274	0,27	130x50	25x4x39	max 122 x max 40	36,5x26,5x45	12	324	150	275	
Stiro soft "L"	12043010	8001244011496	0,31	136x58	25x4,5x39	max 126 x max 48	36,5x26,5x51	12	216	117	243	

# Stiro Top

## Jacquard: stiratura professionale

La foderina ideale, tessuto elasticizzato ad alte prestazioni e spesso mollettone: morbida, scorrevole, aderisce perfettamente all'asse e assorbe il vapore in eccesso: il massimo delle prestazioni Confezione con touch-patch di prova

## Jacquard: professional ironing

The ideal cover, highperformance elasticised fabric and a thick felt pad: soft and fluid, it grips the board perfectly and absorbs the excess steam: top performance. Sample patch on the pack

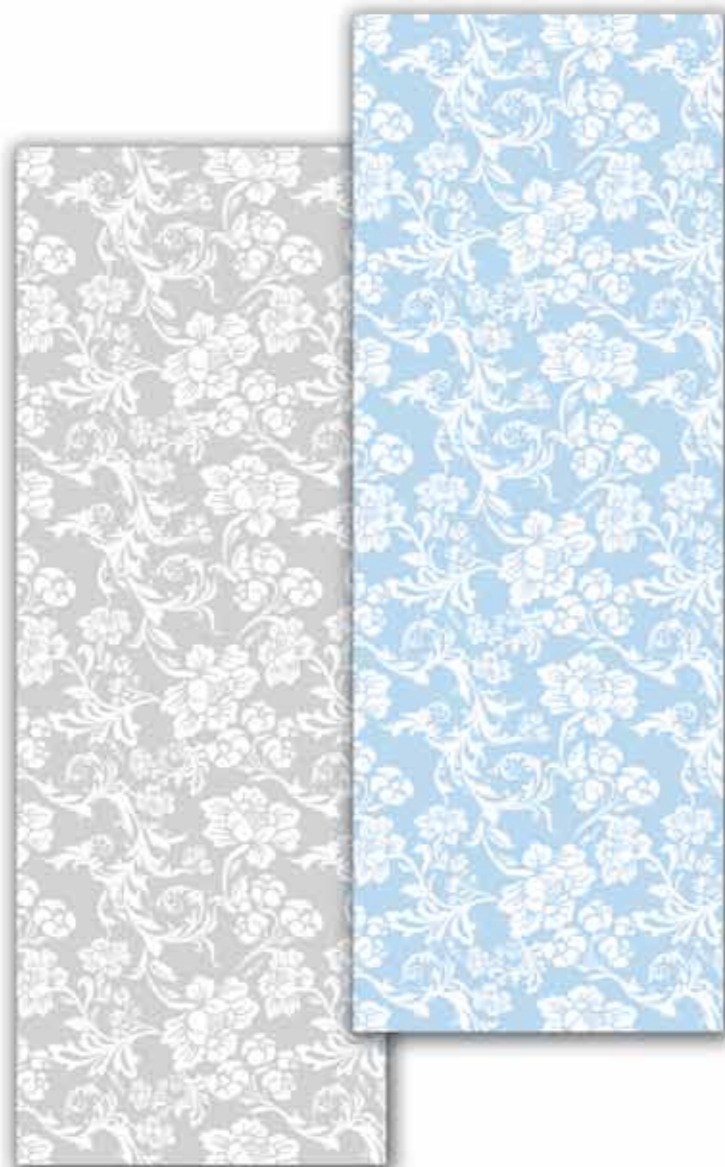

## Jacquard: Wie ein Profi bügeln

Ein idealer Bezug aus elastischem Stoff, äußerst widerstandsfähig und mit einer dicken Moltonunterseite. Er ist weich, gleitfähig, passt sich genau dem Bügelbrett an und nimmt den überschüssigen Dampf auf. Eine beachtliche Leistung. Verpackung mit einem Materialmuster zum Anfassen

## Jacquard: repassage professionnel

La housse idéale en tissu élastifié à hautes performances et molleton épais ; souple, glissante, cette housse adhère parfaitement à la table à repasser et absorbe tout excès de vapeur: le maximum des performances. Échantillon de tissu à l'extérieur du paquet

## Jacquard: planchado profesional

La funda ideal en tejido elasticizado de altas prestaciones con grueso acolchado; es suave, deslizante, se adhiere a la tabla perfectamente y absorbe el vapor en exceso: la máxima eficacia. Presentación con muestra táctil de prueba

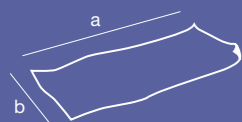

Item	Gimi	Ean	1 pz	Kg		Aperto		Chiuso		n° pz	n° pz	h=cm	n° pz
				Open	Folded	axb=cm	axb=cm	axb=cm	axbxc=cm				
Stiro top	12053000	8001244011557	0,33	138x56	25x6x39	max 126 x max 48	36,5x26,5x33,5	6	216	149	185		

# Wrappy

## Telo da stiro per tavolo

**Quanto** 140x70 cm  
**Categoria** Mollettone in poliestere 100% accoppiato a tessuto in cotone 100% stampato  
**Perché** Indispensabile per stirare sulla tavola della cucina o della sala da pranzo

## Tisch-Bügeltuch

**Leinenlänge** 140x70 cm  
**Material** Moltonunterlage aus 100% Polyester und bedruckter Bezug aus 100% Baumwolle  
**Merkmale** Zum Bügeln auf dem Küchentisch oder Esstisch einfach unentbehrlich

## Ironing blanket

**What size** 140x70 cm  
**Category** 100% polyester flannel bonded with printed 100% cotton fabric  
**Why** Indispensable for ironing on the table in the kitchen or dining room



## Toile de repassage pour table

**Combien** 140x70 cm  
**Catégorie** Molleton 100% polyester doublé de tissu 100% coton imprimé  
**Où** Indispensable pour repasser sur la table de la cuisine ou de la salle à manger

## Paño para mesa de planchar

**Cuánto** 140x70 cm  
**Categoría** Base de muletón en poliéster 100% mas tepido de algodón 100% estampado  
**Porqué** Imprescindible para planchar en la mesa de la cocina o del comedor



# Planet

## Lo stiramaniche indispensabile!

**Quanto** Piano rete lunghezza 52 cm  
**Categoria** Acciaio verniciato. Foderina 100% cotone con mollettone.  
**Perché** Per stirare in maniera impeccabile le maniche di camicie e giacche

## Das unentbehrliche Ärmelbügelbrett!

**Maße** Auflagefläche 52 cm Länge  
**Material** Stahl, lackiert. Bügeltischbezug aus 100% Baumwolle mit Moltonunterseite  
**Merkmale** Perfektes Bügeln von Hemden- und Jackenärmeln

## The essential sleeve board!

**What size** Board length: 52 cm  
**Category** Painted steel. 100% cotton ironing board cover with felt pad  
**Why** For impeccable shirt and jacket sleeves

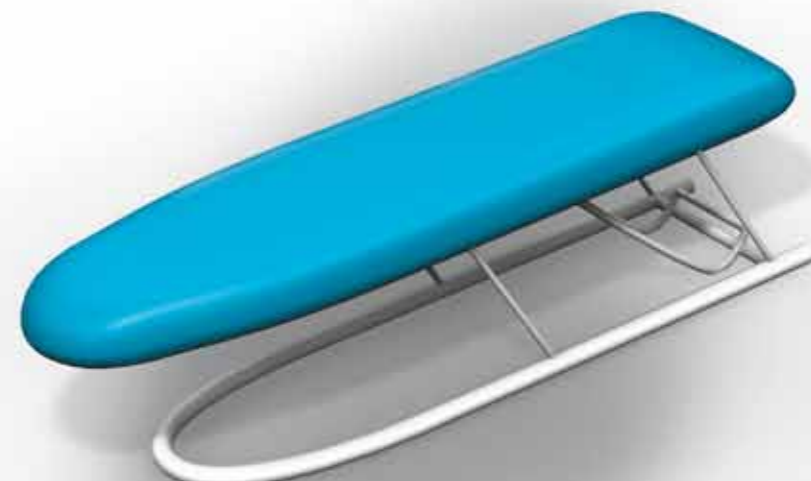

## La jeannette indispensable!

**Taille** Plateau 52 cm de long  
**Catégorie** Acier peint. Housse en coton 100% avec molleton pour table à repasser  
**Avantages** Pour repasser de manière impeccable les manches des chemises et des vestes

## ¡El accesorio indispensable para planchar mangas!

**Cuánto** Longitud del tablero de red expandida 52 cm  
**Categoría** Acero pintado. Funda de algodón 100% con muletón para tablas de planchar  
**Porqué** Para planchar de manera impecable las mangas de camisas y chaquetas

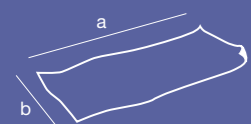

Item	Gimi	Ean	1 pz	axb-cm	axbxc-cm	axbxc-cm	n° pz	n° pz	h-cm	n° pz	Kg	Aperto	Chiuso	Kg	Aperto	Chiuso	Kg	Aperto	Chiuso	
												Open	Folded			Open			Folded	
Wrappy	12910010	8001244008281	0,41	140x70	25x7x43	36,5x26,5x51	12	216	117	243										

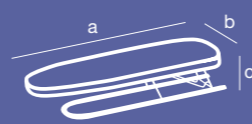

Item	Gimi	Ean	1 pz	axbxc-cm	axbxc-cm	axbxc-cm	n° pz	n° pz	h-cm	n° pz	Kg	Aperto	Chiuso	Kg	Aperto	Chiuso	Kg	Aperto	Chiuso	
												Open	Folded		Open	Folded				
Planet	12760623	8001244003040	0,75	52x12x10	12x4x59	41x14x60	12	360	135	348										

# Carrelli portaspesa e portatutto

# Bella e Brava



## Una piccola borsa che diventa un carrello!

**Categoria** Sacca in tessuto impermeabilizzato  
**Quanto** 38 lt  
**Perché** Le ruote e i piedini ripiegabili trasformano in pochi secondi una piccola valigia morbida in un pratico carrello

## A small bag that turns into a trolley!

**Category** Bag made of waterproofed fabric  
**What size** 38 L  
**Why** The foldaway wheels and feet let you transform this small soft suitcase into a practical trolley in just a few seconds

## Eine kleine Tasche, die zu einem Einkaufsroller wird!

**Material** Tasche aus imprägniertem Stoff  
**Inhalt** 38 Liter  
**Merkmale** Klappräder verwandeln die kleine, weiche Tasche in wenigen Sekunden in einem praktischen Einkaufsroller

## Un petit sac qui se transforme en poussette!

**Matière** Sac en tissu imperméabilisé  
**Contenance** 38 L  
**Avantages** Grâce à ses roues et ses béquilles repliables, le sac se transforme en un clin d'oeil en poussette

## ¡Un pequeño bolso que se transforma en carro!

**Categoría** Bolsa en tejido impermeabilizado  
**Cuánto** 38 L  
**Porqué** Las ruedas y los pies plegables transforman en pocos segundos un pequeño y blando bolso en un práctico carro



Versione economica mod. **Brava**  
 Basic version mod. **Brava**  
 Sparsame Fassung Mod. **Brava**  
 Modèle économique mod. **Brava**  
 Versión económica mod. **Brava**

Portaspesa Shopping trolleys						
Capienza Capacity	Nome prodotto Item	Plus				
		Esclusiva Gimi Gimi exclusive	Blocco ruote Wheels block	Porta ombrello Umbrella holder	Maniglia porta sacchetto Shopper handle	Altro Other
38	Bella					ruote e piedini ripiegabili foldaway wheels and feet
	Brava					ruote e piedini ripiegabili foldaway wheels and feet
45	Argo					chiusura a coulisse coulisse closure
48	Easy	✓		✓		
48	Ideal	✓		✓		
	Extro	✓	✓	✓	✓	
	Family	✓	✓	✓	✓	borsa termica cool bag
	Market	✓	✓	✓	✓	chiusura a coulisse coulisse closure
	Ulysse	✓	✓			struttura in alluminio aluminium frame
	My Porter	⊗	✓			
48	Tris	⊗	✓			sistema a 3 ruote three wheels system
	Four 4	✓	✓	✓		4 ruote 4 wheels coprimaniglia soft-touch soft-touch cover

Portatutto Multi-functional carts					
Categoria Category	Nome prodotto Item	Plus			
		Alluminio Aluminium	Manico telescopico Telescopic frame	Blocco ruote Wheels block	Altro Other
Portazaino Backpack trolley	Fly School	✓	✓	✓	cinghia catarifrangente cat's eye belt
Portavaligie Suitcase trolley	Atos				
Portavaligie Suitcase trolley	Alex	✓	✓		

⊗ = Nitrogen Technology

Per descrizioni dettagliate consultare le pagine dei singoli prodotti.  
 For more details please see the related product pages.



Item	Gimi	Ean	L	1 pz	kg	axbxc=cm	axbxc=cm	axbxc=cm	n° pz	n° pz	h=cm	n° pz
Bella	15054600	8001244007840	38	1,16	15	38x22,5x69	30x7x45	47x37x41	12	180	138	168
Brava	15070205	8001244050013	38	1,03	15	38x22,5x69	30x7x45	47x37x41	12	180	138	168

# Argo

## Bello ed essenziale

**Categoria** Struttura in acciaio con particolari in resina ad alta resistenza. Ruote gommate.

**Quanto** 45 lt

**Perché** Solido ma snello e leggero, facile da richiudere, curato nei minimi dettagli. La sacca lavabile chiusa da una coulisse è dotata di una capiente tasca anteriore con zip. Maniglia ergonomica.

## The trolley that meets all needs

**Category** Steel frame with high resistant resin details. Rubber wheels.

**What size** 45 L

**Why** Robust, light and practical, easy to fold away, produced with the greatest care for detail. The washable bag is closed by a coulisse and provided with a large front zip pocket. Ergonomic handle

## Einkaufsroller für jeden Anlass

**Material** Struktur aus Stahl und Bestandteile aus äußerst widerstandsfähigem Harz. Gummiräder.

**Inhalt** 45 Liter

**Merkmale** Robust und doch praktisch und leicht. Zusammenklappbar und bis ins kleinste Detail gepflegt. Abnehmbare Tasche aus waschbarem Stoff, mit großem Reißverschlussfach an der Vorderseite. Ergonomischer Griff.



Argo blue



poliestere



Argo brick red

## La poussette qui répond à toute exigence

**Matière** Structure en acier avec détails en résine à haute résistance. Roues en caoutchouc.

**Contenance** 45 L

**Avantages** Solide, mais léger, pratique et simple à refermer, soigné dans les détails. Le sac lavable fermé par une coulisse est doté d'une ample poche frontale zippée. Poignée ergonomique.

## El carro que responde a todas las necesidades

**Categoría** Estructura en acero con piezas en resina de alta resistencia. Ruedas de goma.

**Cuánto** 45 litros

**Porqué** Sólido y a la vez sutil y ligero, fácil de cerrar, cuidado en los mínimos detalles. El saco lavable se cierra con un cordel y cuenta con un gran bolsillo delantero con cremallera. Empuñadura ergonómica.



Aperto  
Open

Chiuso  
Folded



Item	Gimi	Ean	L	1 pz	Kg	axbxc=cm	axbxc=cm	axbxc=cm	n° pz	n° pz	h=cm	n° pz
Argo blue	15515500	8001244010697	45	1,86	30	37x33x95,5	37x7,5x89,5	39x19x92	4	48	107	58
Argo brick red	15515500	8001244010604	45	1,86	30	37x33x95,5	37x7,5x89,5	39x19x92	4	48	107	58

# Easy

## Bello ed essenziale

**Categoria** Struttura in acciaio e base in resina ad alta resistenza

**Quanto** 48 lt

**Perché** Sacca estraibile in tessuto lavabile; il carrello si chiude in un secondo grazie al pulsante sulla base o, togliendo la sacca, può diventare un utilissimo carrello portatutto. Alloggio porta ombrello.

## Beautiful and essential

**Category** Frame made of steel, base made of high-resistance resin

**What size** 48 L

**Why** Removable bag made of washable fabric; the trolley can be closed in a second thanks to the button on the base. Removing the bag, it turns into an extremely useful general-purpose trolley. Umbrella holder.

## Schön und schlicht

**Material** Struktur aus Stahl, Basis aus hoch beständigem Kunststoff

**Inhalt** 48 Liter

**Merkmale** Abnehmbare Tasche aus waschbarem Stoff; der Roller kann per Druckknopf sekundenschnell zusammengeklappt oder zu einem sehr nützlichen Allzweck-Roller umgerüstet werden. Inkl. Schirmhalter.



BREVETTATO  
PATENTED

## Belle et essentielle

**Matière** Structure en acier et embase en résine extrêmement résistante

**Contenance** 48 L

**Avantages** Sac amovible en tissu lavable; un bouton permet d'arrêter instantanément la poussette. Son sac amovible peut servir de sac à provisions ou tout autre usage. Equipé d'un porte-parapluie.

## Bonito y esencial

**Categoría** Estructura de acero y base en resina de alta resistencia

**Cuánto** 48 L

**Porqué** Bolsa extraíble en tejido lavable; el carro se cierra en un segundo gracias al botón en la base, o, quitando la bolsa, puede transformarse en un carro muy útil para llevar de todo. Dotado de un espacio para el paraguas.



# Ideal

## Semplice, elegante, conveniente!

**Categoria** Struttura in acciaio e base in resina ad alta resistenza

**Quanto** 48 lt

**Perché** sacca estraibile in tessuto impermeabilizzato, maniglia ergonomica, ruote di gomma morbida e silenziosa. Alloggio porta ombrello.

## Simple, elegant and practical!

**Category** Frame made of steel, base made of high-resistance resin

**What size** 48 L

**Why** Removable bag made of waterproofed fabric, ergonomic handle, soft and silent rubber wheels. Umbrella holder.

## Einfach, elegant und preisgünstig!

**Material** Struktur aus Stahl, Basis aus hoch beständigem Kunststoff

**Inhalt** 48 Liter

**Merkmale** Abnehmbare Tasche aus imprägniertem Stoff, ergonomischer Griff, Räder aus leisem Weichgummi. Inkl. Schirmhalter.



BREVETTATO  
PATENTED

## Simple, élégante, avantageuse!

**Catégorie** Structure en acier et embase en résine extrêmement résistante

**Combien** 48 L

**Pourquoi** Sac amovible en tissu imperméabilisé, poignée ergonomique, roues en caoutchouc souple et silencieux. Equipé d'un porte-parapluie.

## ¡Simple, elegante, conveniente!

**Categoría** Estructura de acero y base en resina de alta resistencia

**Cuánto** 48 L

**Porqué** Bolsa extraíble en tejido impermeabilizado, asa ergonómica, ruedas silenciosas de goma suave. Dotado de un espacio para el paraguas.



Aperto  
Open

Chiuso  
Folded



Item	Gimi	Ean	L	1 pz	Kg	axbxc=cm	axbxc=cm	axbxc=cm	n° pz	n° pz	h=cm	n° pz
Easy	15177607	8001244005891	48	2,24	30	38,5x39x102	38,5x16x102	39,5x39,5x101,5	4	48	218	25



Aperto  
Open

Chiuso  
Folded



Item	Gimi	Ean	L	1 pz	Kg	axbxc=cm	axbxc=cm	axbxc=cm	n° pz	n° pz	h=cm	n° pz
Ideal	15331717	8001244589803	48	2,43	30	38,5x39x102	38,5x16x102	39,5x39,5x101,5	4	48	218	25
								80x39x102	4	24	219	13

## Stile impeccabile, praticità garantita

**Categoria** Struttura in acciaio e base in resina ad alta resistenza

**Quanto** 48 lt

**Perché** Sacca estraibile in tessuto lavabile con tasca esterna chiusa da zip; il carrello si chiude in un secondo grazie al pulsante sulla base o, togliendo la sacca, può diventare un utilissimo carrello portatutto. Alloggio porta ombrello.

## Impeccable style, guaranteed practicality

**Category** Frame made of steel, base made of high-resistance resin

**What size** 48 L

**Why** Removable bag made of washable fabric with exterior zip-pocket; the trolley can be closed in a second thanks to the button on the base or, removing the bag, it turns into an extremely useful general-purpose trolley. Umbrella holder.

## Einwandfreier Stil, garantierte Zweckmäßigkeit

**Material** Struktur aus Stahl, Basis aus hoch beständigem Kunststoff

**Inhalt** 48 Liter

**Merkmale** Abnehmbare Tasche aus waschbarem Stoff, Außenfach mit Reißverschluss; der Roller kann per Druckknopf sekundenschnell zusammengeklappt oder zu einem sehr nützlichen Allzweck-Roller umgerüstet werden. Inkl. Schirmhalter.

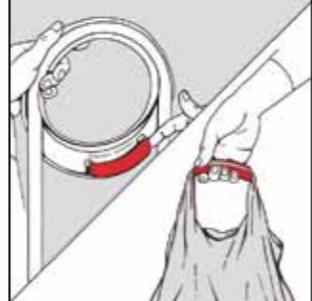

poliestere



## Pratique, au style impeccable

**Matière** Structure en acier et embase en résine extrêmement résistante

**Contenance** 48 L

**Avantages** Sac amovible en tissu lavable avec poche externe à glissière; un bouton permet d'arrêter instantanément la poussette. Son sac amovible peut servir de sac à provisions ou tout autre usage. Equipé d'un porte-parapluie.

## Estilo impecable, practicidad garantizada

**Categoría** Estructura de acero y base en resina de alta resistencia

**Cuánto** 48 L

**Porqué** Bolsa extraíble de tejido lavable provista de bolsillo exterior con cremallera; el carro se cierra en un segundo gracias al botón en la base, o, quitando la bolsa, puede transformarse en un carro multiuso. Dotado de un espacio para el paraguas.



## Dinamico e moderno come le famiglie di oggi

**Categoria** Struttura in acciaio e base in resina ad alta resistenza

**Quanto** 48 lt

**Perché** Sacca estraibile in tessuto lavabile, maxitasca esterna chiusa da zip, borsa termica abbinata (capacità 10 litri); il carrello si chiude in un secondo grazie al pulsante sulla base o, togliendo la sacca, può diventare un utilissimo carrello portatutto. Alloggio porta ombrello.

## Dynamic and innovative for modern families

**Category** Frame made of steel, base made of high-resistance resin

**What size** 48 L

**Why** Removable bag made of washable fabric with exterior zip-maxi-pocket + separate cool bag (capacity 10 litres); the trolley can be closed in a second thanks to the button on the base or, removing the bag, it turns into an extremely useful general-purpose trolley. Umbrella holder.

## Dynamisch und modern wie die heutigen Familien

**Material** Struktur aus Stahl, Basis aus hoch beständigem Kunststoff

**Inhalt** 48 Liter

**Merkmale** Abnehmbare Tasche aus waschbarem Stoff, großes Außenfach mit Reißverschluss, mit dazu passender Thermotasche (Fassungsvermögen 10 Liter); der Roller kann per Druckknopf sekundenschnell zusammengeklappt oder zu einem sehr nützlichen Allzweck-Roller umgerüstet werden. Inkl. Schirmhalter.

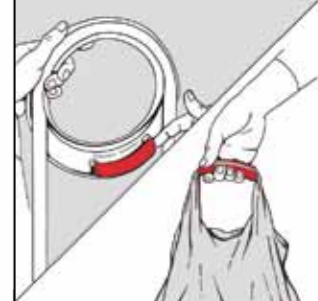

poliestere



## Dynamique et innovante, tout comme les familles modernes

**Matière** Structure en acier et embase en résine extrêmement résistante

**Contenance** 48 L

**Avantages** Sac amovible en tissu lavable avec maxi-poche externe à glissière et sac thermique séparé (capacité 10 litres); un bouton permet d'arrêter instantanément la poussette. Son sac amovible peut servir de sac à provisions ou tout autre usage. Equipé d'un porte-parapluie.

## Dinámico y moderno como las familias de hoy

**Categoría** Estructura de acero y base en resina de alta resistencia

**Cuánto** 48 L

**Porqué** Bolsa extraíble de tejido lavable provista de súper bolsillo exterior con cremallera, bolsa térmica a juego (capacidad 10 litros); el carro se cierra en un segundo gracias al botón en la base, o, quitando la bolsa, puede transformarse en un carro multiuso. Dotado de un espacio para el paraguas.



Item	Gimi	Ean	L	1 pz	Kg	axbxc=cm	axbxc=cm	axbxc=cm	n° pz	n° pz	h=cm	n° pz
Extro	15795827	8001244710009	48	2,68	30	38,5x39x102	38,5x16,5x102	39,5x39,5x101,5	4	48	218	25
								80x39x102	4	24	219	13



Item	Gimi	Ean	L	1 pz	Kg	axbxc=cm	axbxc=cm	axbxc=cm	n° pz	n° pz	h=cm	n° pz
Family	15795847	8001244750005	48	2,60	30	38,5x39x102	38,5x16,5x102	39,5x39,5x101,5	4	48	218	25
								80x39x102	4	24	219	13



# Market

## Il carrello per la donna dal gusto sicuro

**Categoria** Struttura in acciaio e base in resina ad alta resistenza

**Quanto** 48 lt

**Perché** Sacca estraibile in tessuto lavabile, con tasca esterna chiusa da zip e coulisse di chiusura sotto la pattella; il carrello si chiude in un secondo grazie al pulsante sulla base o, togliendo la sacca, può diventare un utilissimo carrello portatutto.

Alloggio porta ombrello.

## The shopping trolley for the stylish woman

**Category** Frame made of steel, base made of high-resistance resin

**What size** 48 L

**Why** Removable bag made of washable fabric with exterior zip pocket and coulisse closure under the flap; the trolley can be closed in a second thanks to the button on the base or, removing the bag, it turns into an extremely useful general-purpose trolley. Umbrella holder.

## Der Einkaufsroller für die selbstbewusste Frau

**Material** Struktur aus Stahl, Basis aus hoch beständigem Kunststoff

**Inhalt** 48 Liter

**Merkmale** Abnehmbare Tasche aus waschbarem Stoff, mit externem Reißverschlussfach und Verschleißleiste unter der Abschließklappe; der Roller kann per Druckknopf sekundenschnell zusammengeklappt oder zu einem sehr nützlichen Allzweck-Roller umgerüstet werden. Inkl. Schirmhalter.

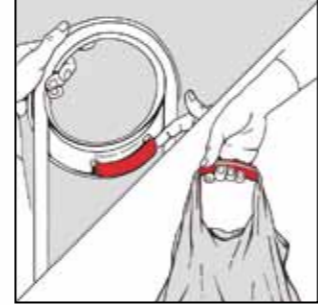

# My Porter

## Il carrello per chi non si accontenta

**Categoria** Telaio in acciaio verniciato

**Quanto** 48 lt

**Perché** Dotato di maniglia ergonomica e di sacca estraibile con doppia tasca frontale chiusa da zip

## The shopping trolley for the most demanding woman

**Category** Frame made of painted steel

**What size** 48 L

**Why** Provided with ergonomic handle and removable bag with two front zip pockets

## Der Einkaufsroller für Anspruchsvolle

**Material** Gestell aus lackiertem Stahl

**Inhalt** 48 Liter

**Merkmale** Mit ergonomischem Griff, abnehmbarer Einkaufstasche und vorderem Doppelfach mit Reißverschluss



## La poussette pour la femme au goût incontestable

**Matière** Structure en acier et embase en résine extrêmement résistante

**Contenance** 48 L

**Avantages** Sac amovible en tissu lavable avec poche externe à glissière et coulisse de fermeture sous la patte; un bouton permet d'arrêter instantanément la poussette. Son sac amovible peut servir de sac à provisions ou tout autre usage. Equipé d'un porte-parapluie.

## El carro de compra para la mujer que sabe lo que quiere

**Categoría** Estructura de acero y base en resina de alta resistencia

**Cuánto** 48 L

**Porqué** Bolsa extraíble de tejido lavable, bolsillo exterior con cremallera y cierre coulisse bajo la tapa; el carro se cierra en un segundo gracias al botón en la base, o, quitando la bolsa, puede transformarse en un carro multiuso. Dotado de un espacio para el paraguas.



## La poussette pour la femme exigeante

**Matière** Structure en acier peint

**Contenance** 48 L

**Avantages** Pourvue de poignée ergonomique et de sac amovible à double poche avant à glissière

## El carro de compra para quien no se deja convencer fácilmente

**Categoría** Bastidor de acero pintado

**Cuánto** 48 L

**Porqué** Dotado de manilla ergonómica y bolsa extraíble con doble bolsillo frontal con cremallera



Aperto  
Open

Chiuso  
Folded



Item	Gimi	Ean	L	1 pz	Kg	axbxc=cm	axbxc=cm	axbxc=cm	n° pz	n° pz	h=cm	n° pz
Market	15795857	8001244760004	48	2,56	30	38,5x39x102	38,5x16,5x102	39,5x39,5x101,5	4	48	218	25
								80x39x102	4	24	219	13



Aperto  
Open

Chiuso  
Folded



Item	Gimi	Ean	L	1 pz	Kg	axbxc=cm	axbxc=cm	axbxc=cm	n° pz	n° pz	h=cm	n° pz
My Porter	15961012	8001244961012	48	2,91	30	39x37x101,5	39x23,5x101,5	59,5x39,5x102,5	5	20	117,5	21
								80x39x102	4	12	117	13

## Per salire comodamente le scale!

**Categoria** Telaio in acciaio verniciato  
**Quanto** 48 lt  
**Perché** Il sistema a tre ruote consente di salire facilmente i gradini; sacca estraibile in tessuto lavabile con doppia tasca esterna chiusa da zip e maniglia ergonomica

## Easy to get up stairs!

**Category** Frame made of painted steel  
**What size** 48 L  
**Why** The system with three wheels makes it easy to get this trolley up stairs; removable bag made of washable fabric with two front zip-pocket and ergonomic handle

## Bequem auch zum Treppensteigen!

**Material** Gestell aus lackiertem Stahl  
**Inhalt** 48 Liter  
**Merkmale** Das Drei-Räder-System macht den Wagen auch für Treppen tauglich; Mit ergonomischem Griff, abnehmbarer Einkaufstasche und vorderem Doppelfach mit Reißverschluss



## Pour monter aisément l'escalier!

**Catégorie** Structure en acier peint  
**Combien** 48 L  
**Pourquoi** Le système à trois roues permet de monter aisément l'escalier; sac amovible en tissu lavable pourvu de double poche zippée et poignée ergonomique

## ¡Para subir cómodamente las escaleras!

**Categoría** Estructura de acero pintado  
**Cuánto** 48 L  
**Porqué** El sistema con tres ruedas permite subir fácilmente los peldaños; bolsa extraíble en tejido lavable con doble bolsillo frontal con cremallera y asa ergonómica



## L'amico del tuo shopping!

**Categoria** Struttura in alluminio con dettagli in resina plastica  
**Quanto** 48 lt  
**Perché** Leggerissimo, richiudibile, autenticamente fashion. La sacca è estraibile e lavabile, antipioggia e antistrappo, con tasca interna chiusa da zip. Blocco-ruota per poterlo appoggiare chiuso a parete e catarifrangente sul cerchione.

## Your shopping friend!

**Category** Aluminium construction with resin details  
**What size** 48 L  
**Why** Very light, foldable and trendy. The bag, which can be removed for washing, is rainproof and tearproof, with internal zip-pocket. Wheels can be blocked to lean it closed against a wall. Cat's eye on the rim.

## Der Shopping-Freund!

**Material** Alugestell mit Kunstharzeinsätzen  
**Inhalt** 48 Liter  
**Merkmale** Extra leicht, zusammenklappbar, einfach Fashion. Abnehmbare und waschbare Tasche, wasserund reißfest, Innen tasche mit zip Radbremse, um den Shopper zusammengeklappt an einer Wand abstellen zu können. Felge mit Rückstrahler.



## L'ami des courses!

**Matière** Structure en aluminium avec détails en résine  
**Contenance** 48 L  
**Avantages** Très léger, pliant, vraiment à la mode. Le sac amovible est lavable, anti-pluie et anti-déchirure, avec poche interne à glissière. Blocage des roues pour l'appuyer fermé contre une paroi. Cataphote sur la jante.

## ¡El compañero de sus compras!

**Categoría** Estructura de aluminio con piezas de resina plástica  
**Cuánto** 48 litros  
**Por qué** Muy ligero, plegable, auténticamente a la moda. La bolsa es extraíble y lavable, antilluvia y antidesgarre, provista de bolsillo interior con cremallera. Bloqueador de rueda para apoyarlo cerrado en la pared. Reflector luminoso montado en la llanta.



Item	Gimi	Ean	L	1 pz	Kg	Aperto Open		Chiuso Folded		axbxc=cm	n° pz	n° pz	h=cm	n° pz
						axbxc=cm	axbxc=cm	axbxc=cm	n° pz					
Tris	15961012	8001244002494	48	3,1	30	53,5x47,5x99,5	53,5x20x94	94x24,5x98,5	4	16	113,5	16		
								79x59x105	4	8	120	8		



Item	Gimi	Ean	L	1 pz	Kg	Aperto Open		Chiuso Folded		axbxc=cm	n° pz	n° pz	h=cm	n° pz
						axbxc=cm	axbxc=cm	axbxc=cm	n° pz					
Ulysse	15829500	8001244010192	48	1,83	30	38,5x34x102	38,5x15x102	48x39,5x103,5	6	30	118,5	30		

# Four4

## Finalmente un carrello italiano a 4 ruote!

**Categoria** Struttura in acciaio, 4 ruote robuste, maniglia ergonomica con coprimaniglia soft-touch

**Quanto** sacca supercapiente da 60 litri

**Perché** Questo carrello può essere spinto oltre che trainato, e riduce di molto la fatica specialmente a pieno carico. La sacca è estraibile e lavabile, dotata di tasca frontale chiusa da zip.

Premendo il pulsante sulla base il carrello si chiude. Alloggio porta ombrello.

## Finally an Italian 4-wheel trolley!

**Category** Steel construction, 4 sturdy wheels, ergonomic handle with soft-touch cover

**What size** Extra-large 60-liter bag

**Why** This trolley can be both pushed and pulled, thus minimising the user's effort, especially when fully loaded. The bag can be removed for washing and is provided with frontal zipped pocket. The trolley can be closed by pressing the button on its base. Umbrella holder.

## Jetzt ein italienischer Vierrad-Einkaufsroller! Evergreen

**Material** Stahlstruktur, 4 robuste Rollen, ergonomischer Griff mit Soft-Touch-Griffverkleidung

**Inhalt** 60 Liter

**Merkmale** Diesen Einkaufsroller kann man sowohl schieben als auch ziehen, mit erheblicher Reduzierung der Anstrengung insbesondere bei voller Ladung. Die ausziehbare und waschbare Tasche hat ein, durch vorderen Reißverschluss, verschließbares Fach. Dank des, auf der Basis des Einkaufsrollers befindlichen Druckknopfes kann man ihn zusammenklappen. Inkl. Schirmhalter.



BREVETTATO  
PATENTED

poliestere



## Finalement une poussette italienne à 4 roues!

**Catégorie** Structure en acier, 4 roues robustes, poignée ergonomique avec couvre-poignée «soft-touch»

**Combien** Sac extra-large de 60 litres

**Avantages** Cette poussette peut être poussée et tirée, ce qui réduit énormément l'effort, surtout quand elle est complètement chargée. Le sac est détachable et lavable, doté d'une poche frontale zippée. En appuyant sur le bouton à l'embase de la poussette elle se ferme.

Equipé d'un porte-parapluie.

## ¡Por fin un carro de compra italiano de 4 ruedas!

**Categoría** Estructura de acero, 4 ruedas sólidas, manillar ergonómico con cubremanillar soft-touch

**Cuánto** Bolsa súper grande de 60 litros

**Porqué** Este carro de compra se puede empujar y tirar de él, con lo que disminuye el cansancio sobre todo con la bolsa repleta. La bolsa es extraíble y lavable, provista de bolsillo frontal con cremallera. Pulsando el botón en la base se cierra el carro de compra y así se reduce su tamaño. Dotado de un espacio para el paraguas.



Aperto  
Open

Chiuso  
Folded



Item	Gimi	Ean	L	1 pz	Kg	axbxc-cm	axbxc-cm	axbxc-cm	n° pz	n° pz	h-cm	n° pz
Four 4	15230720	8001244009516	60	3,10	30	39x53x95	39x26x98,5	101x61x40	5	30	135	20

# Fly School

## Scuola leggera e schiena dritta!

**Categoria** Struttura telescopica in alluminio e resina traslucida ad alta resistenza. Base autoportante con alette antiribaltamento per lo zaino

**Quanto** portata 15 kg

**Perché** Spesso il carico dei libri è eccessivo - superiore alla soglia del 15% del peso del bambino - con conseguenti accertati rischi per la schiena: l'uso regolare del carrellino è raccomandabile per minimizzare lo sforzo e migliorare la postura. Ruote gommata scorrevoli e resistenti. Cintura bloccazaino regolabile e catarifrangente, alloggiamento portaombrellino.

## Light school and right back!

**Category** Telescopic frame made of aluminium and high resistant translucent resin. Self-bearing base with anti-tilting wings for the schoolbag

**What size** 15 kg

**Why** The weight of books often exceeds the threshold of 15% of the bodyweight. This entails proven risks for the back: it is recommended to regularly use trolleys in order to minimise the effort and improve the posture.

Sliding and resistant rubber wheels. Adjustable and retroreflecting strap for the schoolbag and umbrella holder.

## Schulbücher tragen, leicht gemacht. Schonen Sie den Rücken Ihrer Kinder!

**Material** Teleskopstruktur aus Aluminium mit äußerst widerstandsfähiger, durchsichtiger Kunstharzbeschichtung. Selbsttragende Struktur mit kippstabilen Flügeln für den Schulranzen.

**Inhalt** 15 kg

**Merkmale** Oft sind die Schulbücher viel zu schwer - mehr als 15% des Körpergewichts eines Kindes - was bekanntlich unerwünschte Folgen für den Rücken haben kann. Deshalb wird der Gebrauch eines Rollers empfohlen, um die Belastung zugunsten einer besseren Körperhaltung zu beschränken. Widerstandsfähige Gummiräder. Einstellbarer Riemen zur Befestigung des Schulranzens, Rückstrahler und Regenschirmtasche.

## École légère et dos droit!

**Matière** Structure télescopique en aluminium et résine translucide à haute résistance. Base autoportante à ailettes anti-renversement pour le sac à dos.

**Charge maximale** 15 kg

**Avantages** Souvent le poids des livres est excessif, c'est à dire qu'il dépasse le seuil de 15% du poids de l'enfant, ce qui crée des risques démontrés pour le dos: l'emploi régulier d'un porte-charges est souhaitable afin de minimiser l'effort et d'améliorer la posture.

Roues en caoutchouc glissantes et résistantes. Courroie pour sac à dos réglable et réfléchissante; porte-parapluie.

## ¡Escuela ligera, espalda derecha!

**Categoría** Estructura telescópica en aluminio y resina translúcida de alta resistencia. Base autoportante con aletas antivuelco para la mochila

**Cuánto** 15 kg

**Porqué** Por lo general el peso de los libros es excesivo y supera el límite del 15% del peso del niño, lo que conlleva comprobados riesgos para la espalda; por ello se recomienda el uso habitual del carro para reducir el esfuerzo y mejorar la postura.

Ruedas de goma deslizantes y resistentes. Correa de sujeción ajustable y reflectante y soporte paraguero.



BREVETTATO  
PATENTED



Aperto  
Open

Chiuso  
Folded



Item	Gimi	Ean	1 pz	kg	axbxc=cm	axbxc=cm	axbxc=cm	n° pz	n° pz	h=cm	n° pz
Fly School	15220525	8001244004313	1,45	15	34x29x87	29x11x59	80x34,5x32	6	72	143	67

# Atos

## Il carrello portavaligie semplice e conveniente!

**Categoria** struttura ripiegabile in acciaio verniciato

**Quanto** 30 kg

**Perché** Dotato di cinghie elastiche per il fissaggio dei carichi

## The suitcase trolley, simple and good value!

**Category** Foldaway frame made of painted steel

**What size** 30 kg

**Why** Comes with elastic straps for fixing loads

## Der einfache und preiswerte Kofferrwagen!

**Material** Klappbare Struktur aus lackiertem Stahl

**Inhalt** 30 kg

**Merkmale** Ausgestattet mit elastischen Riemen zur Befestigung des Gepäcks

## Le porte-charge simple et pratique!

**Matière** Structure pliable en acier peint

**Charge maximale** 30 kg

**Avantages** Pourvu de tendeurs pour la fixation des charges

## ¡El carro portamaletas sencillo y conveniente!

**Categoría** Estructura plegable de acero pintado

**Cuánto** 30 kg

**Porqué** Provisto de correas elásticas con ganchos para fijar las cargas



# Alex

## Il portavaligie leggero!

**Categoria** Struttura telescopica in alluminio con finiture in resina

**Quanto** 30 kg

**Perché** Pesa solo 1,5 Kg; con cinghia elastica per il fissaggio di borse e valigie

## The lightweight suitcase trolley!

**Category** Telescopic frame made of aluminium with resin finish

**What size** 30 kg

**Why** It weighs just 1.5 kg; with elastic strap for fixing bags and suitcases

## Der leichte Kofferrwagen!

**Material** Teleskopstruktur aus Aluminium mit Kunstharzbeschichtung

**Inhalt** 30 kg

**Merkmale** Wiegt nur 1,5 kg; ausgestattet mit elastischen Riemen zur Befestigung der Taschen und Koffer

## Le plus léger des porte-charges!

**Matière** Structure télescopique en aluminium et finitions en résine

**Charge maximale** 30 kg

**Avantages** Son poids est d'1,5 kg seulement; avec une courroie élastique permettant de fixer les sacs et les valises

## ¡El portamaletas liviano!

**Categoría** Estructura telescópica de aluminio con acabados en resina

**Cuánto** 30 kg

**Porqué** Pesa sólo 1,5 kg; provisto de correa elástica con ganchos para la fijación de bolsos y maletas



Item	Gimi	Ean	1 pz	kg	Aperto Open		Chiuso Folded		n° pz	n° pz	h=cm	n° pz
					axbxc=cm	axbxc=cm	axbxc=cm	n° pz				
Atos	15040400	8001244764040	1,72	30	31x28x86	31x10x48	52,5x31,5x31	6	144	139	117	



Item	Gimi	Ean	1 pz	kg	Aperto Open		Chiuso Folded		n° pz	n° pz	h=cm	n° pz
					axbxc=cm	axbxc=cm	axbxc=cm	n° pz				
Alex	15020310	8001244765009	1,63	30	26,5x31x90	26,5x10x44	47x29,5x35	6	144	155	123	



Materiale Material	Nome prodotto Item	Portata Loading capacity	Plus		
			Scalini antiscivolo Antislip steps	Chiusura salvaspazio Space saving closing	Altro Other
Acciaio Steel	Tiko 2	kg 150		✓	
	Tiko 3	kg 150		✓	
	Tiko 4	kg 150		✓	
Acciaio Steel	Super Tiko 2	kg 150		✓	
	Super Tiko 3	kg 150		✓	
	Super Tiko 4	kg 150		✓	accessorio multitasche multi-pocket accessory
Alluminio/acciaio Aluminium/steel	Dune 2	kg 150	✓		manico soft-touch soft-touch cover
	Dune 3	kg 150	✓		manico soft-touch soft-touch cover

### Sottilissimo una volta piegato!

**Categoria** Acciaio verniciato

**Quanto** Sostiene fino a 120 kg

**Perché** L'ideale per i piccoli lavori domestici, occupa pochissimo spazio; è disponibile in varie altezze

### Very compact once folded!

**Category** Painted steel

**What size** Supports up to 120 kg

**Why** The ideal stepladder for small jobs at home. It takes up very little space; available in various heights

### Zusammengeklappt extrem platzsparend!

**Material** Stahl, lackiert

**Tragfähigkeit** bis zu 120 kg

**Merkmale** Ideal bei kleineren Hausarbeiten; beansprucht ganz wenig Platz; Tiko ist in verschiedenen Höhen erhältlich

### Très compacte lorsqu'elle est repliée!

**Catégorie** Acier peint

**Combien** Elle peut supporter jusqu'à 120 kg

**Pourquoi** Elle est idéale pour les petits travaux ménagers, puisqu'elle occupe très peu d'espace. Plusieurs hauteurs disponibles.

### ¡Delgadísimo una vez plegado!

**Categoría** Acero pintado

**Cuánto** Sostiene hasta 120 kg

**Porqué** Ideal para pequeñas tareas domésticas, ocupa un espacio muy reducido; se encuentra disponible en diferentes alturas



Aperto  
Open

Chiuso  
Folded



Item	Gimi	Ean	1 pz	kg	axbxc=cm	axbxc=cm	axbxc=cm	n° pz	n° pz	h=cm	n° pz
Tiko 2	13783020	8001244378308	4,20	150	47x54,5x82	47x4x90	48,5x22,5x90,5	6	42	105,5	60
Tiko 3	13783030	8001244378506	5,92	150	47x74x104	47x4,5x115	49x15x116	4	44	131	46
Tiko 4	13783040	8001244378704	7,88	150	47x82x130	47x6x141	48x12x142,5	3	39	157,5	36

# Super Tiko

## Sottilissimo una volta piegato!

**Categoria** Acciaio verniciato

**Quanto** Sostiene fino a 150 kg

**Perché** Il design completamente nuovo rende questa linea di scale a 2, 3 e 4 scalini bella e riconoscibile.

Il modello SuperTiko 4 è corredato dell'accessorio multitasche per avere a portata di mano ciò che serve

## Very compact once folded!

**Category** Painted steel

**What size** Supports up to 150 kg

**Why** The brand new design makes this line of 2, 3 and 4-step ladders very nice and peculiar.

The SuperTiko 4 model is provided with a multi-pocket accessory so that everything you need is at reach



## Zusammengeklappt extrem platzsparend!

**Material** Stahl, lackiert

**Tragfähigkeit** bis zu 150 kg

**Merkmale** Dank des ganz neuen Designs wird diese Leiter-Linie mit 2, 3 oder 4 Stufen schön und unverkennbar.

Das Modell SuperTiko 4 ist mit dem Zubehör "Multitasca" ausgestattet, damit immer alles griffbereit ist

## Très compacte lorsqu'elle est repliée!

**Catégorie** Acier peint

**Combien** Elle peut supporter jusqu'à 150 kg

**Pourquoi** Le dessin tout à fait nouveau de cette ligne d'échelles à 2, 3 et 4 échelons la rend très agréable et reconnaissable. Le modèle SuperTiko 4 est fourni avec un accessoire multi-poches afin que tout le nécessaire soit à la portée de la main

## ¡Delgadísimo una vez plegado!

**Categoría** Acero pintado

**Cuánto** Sostiene hasta 150 kg

**Porqué** Su diseño completamente novedoso proporciona a esta línea de escaleras de 2, 3 y 4 escalones una estética bella y reconocible.

El modelo SuperTiko 4 está provisto del accesorio multibolsillos para tener al alcance de la mano lo que nos sirve.



# Super Tiko

## Sottilissimo una volta piegato!

**Categoria** Acciaio verniciato

**Quanto** Sostiene fino a 150 kg

**Perché** Il design completamente nuovo rende questa linea di scale a 2, 3 e 4 scalini bella e riconoscibile.

## Very compact once folded!

**Category** Painted steel

**What size** Supports up to 150 kg

**Why** The brand new design makes this line of 2, 3 and 4-step ladders very nice and peculiar.

## Zusammengeklappt extrem platzsparend!

**Material** Stahl, lackiert

**Tragfähigkeit** bis zu 150 kg

**Merkmale** Dank des ganz neuen Designs wird diese Leiter-Linie mit 2, 3 oder 4 Stufen schön und unverkennbar.

## Très compacte lorsqu'elle est repliée!

**Catégorie** Acier peint

**Combien** Elle peut supporter jusqu'à 150 kg

**Pourquoi** Le dessin tout à fait nouveau de cette ligne d'échelles à 2, 3 et 4 échelons la rend très agréable et reconnaissable.

## ¡Delgadísimo una vez plegado!

**Categoría** Acero pintado

**Cuánto** Sostiene hasta 150 kg

**Porqué** Su diseño completamente novedoso proporciona a esta línea de escaleras de 2, 3 y 4 escalones una estética bella y reconocible.



# Dune

## La scaletta/sgabello che piacerà alle donne per il suo profilo sinuoso!

**Categoria** Struttura in alluminio con scalini in acciaio e resina

**Quanto** Portata kg 150

**Perché** Bella, solida, sicura con gli ampi scalini dalla texture antiscivolo, nella versione a due scalini è comoda come seduta da lasciare a vista in casa o in negozio.

## The step-stool ladder that every woman will appreciate for its sinuosity!

**Category** Aluminium construction with steel and resin steps

**What size** Capacity kg 150

**Why** Nice, sturdy, safe with wide antislip steps, in the version with two steps, it is a comfortable stool to be used at home or in a shop.

## Die Leiter oder der Hocker, der durch das runde Profil den Frauen gefällt!

**Material** Alugestell mit Stufen aus Stahl und Harz

**Tragfähigkeit** 150 kg

**Merkmale** Schön, robust, sicher mit breiten rutschfesten Stufen. Die 2-Stufen-Ausführung ist auch als Hocker für den Haushalt oder im Geschäft geeignet.

## La petite échelle-escabeau qui sera aimée par les femmes en raison de son profil sinueux!

**Catégorie** Structure en aluminium avec échelons en acier et résine

**Combien** Capacité kg 150

**Pourquoi** Belle, solide, sûre avec d'amples échelons anti-glissement; dans la version à deux échelons, elle fait fonction d'escabeau très confortable à utiliser à la maison ou dans un magasin.

## ¡Escalera/banqueta que encantará a las mujeres por su perfil sinuoso!

**Categoría** Estructura de aluminio con escalones de acero y resina

**Cuánto** Capacidad: 150 kg.

**Por qué** Bonita, sólida, segura con amplios escalones con textura antideslizante; la versión de dos escalones es cómoda como asiento, se puede dejar a la vista en el hogar o en la tienda.



Item	Gimi	Ean	1 pz	kg	Aperto Open		Chiuso Folded		n° pz	n° pz	h=cm	n° pz
					axbxc=cm	axbxc=cm	axbxc=cm	n° pz				
Super Tiko 2	13783025	8001244008694	4,95	150	48x59x84	48x5x91,5	50x17x94	4	32	109	50	
Super Tiko 3	13783035	8001244008700	6,98	150	48x72x108	48x5x117,5	49x14x120,5	3	36	135,5	36	
Super Tiko 4	13783045	8001244008717	9,85	150	48x87x150	48x5x164,5	49,5x10x167	2	32	182	24	



Item	Gimi	Ean	1 pz	kg	Aperto Open		Chiuso Folded		n° pz	n° pz	h=cm	n° pz
					axbxc=cm	axbxc=cm	axbxc=cm	n° pz				
Dune 2	13165320	8001244010109	4,45	150	46x53x83	46x11,5x97	49x38,5x97	4	20	112	21	
Dune 3	13165330	8001244010123	6,34	150	49x68x129	49x15,5x137	52x33x136	3	15	151	12	



Portabiancheria Clothes-hamper			
Nome prodotto Item	Plus		
Carlotta	Esclusiva Gimi Gimi exclusive	chiusura a coulisse coulisse closure	maniglia per il trasporto carry handle

Porta-abiti Clothes-hanger			
Nome prodotto Item	Plus		
	Ruote piroettanti Pivoting wheels	Altezza regolabile Adjustable height	Altro Other
Paco	✓	✓	
Super Paco	✓	✓	6 attaccapanni coordinati 6 matching clothes-hangers prolunghe regolabili adjustable extensions

Appenditutto Clothes-rail			
Nome prodotto Item	Plus		
	Esclusiva Gimi Gimi exclusive	Ganci Hooks	Altro Other
Bingo		5	
Bingo Crystal		5	
Super Bingo Crystal		2	
Bingo Ministick		2	3 inviti portascopa 3 mop and broom-holders
Bingo Stick		8	
Ap-lik	⊗	✓	2 richiudibile richiudibile ing

Porta sacchetti Plastic bags dispenser	
Nome prodotto Item	Plus
Bingo Pocket	fissaggio a ventosa o con viti suction pad/screw fixing 3 ganci 3 multipurpose

## L'alternativa al solito contenitore per la biancheria da lavare!

**Categoria** Sacca in TNT, lavabile, manici in resina opalescente

**Quanto** 60 l

**Perché** Una cuffia interna richiudibile isola la biancheria da lavare e grazie alle maniglie è ideale per portare tutto in lavanderia

## The innovative container for the laundry to be washed!

**Category** Washable bag made of TNT, handles made of opalescent resin

**What size** 60 l

**Why** Provided with an internal cover that can be closed to isolate the laundry to be washed. Thanks to its handles, it is ideal to carry the laundry to be washed.

## Eine Alternative zum Wäschekorb!

**Material** Waschbare Tasche aus TNT, Griffe aus opalisierendem Kunstharz

**Inhalt** 60 Liter

**Merkmale** Die schmutzige Wäsche kann im verschließbaren Innensack verstaut werden. Die Tasche ist mit Griffen versehen, um sie bequem in den Waschraum transportieren zu können.

## L'innovation dans le domaine des conteneurs pour linge à laver!

**Matière** Panier en TNT, lavable, poignées en résine opalescente

**Combien** 60 l

**Pourquoi** Un empiècement resserrable permet d'isoler le linge à laver. Grâce aux poignées, il est idéal pour transporter le linge à la buanderie.

## ¡La alternativa al cesto común de la lavandería!

**Categoría** Saco en TNT lavable, asas en resina tornasolada

**Cuánto** 60 litros

**Por qué** Un saco interno con cierre separa la ropa para lavar y, gracias a las asas, es ideal para transportar a la lavandería.



MARCOMAGGIOMI  
DESIGN



Aperto  
Open

Chiuso  
Folded



Item	Gimi	Ean	L	1 pz	kg	axbxc=cm	axbxc=cm	axbxc=cm	n° pz	n° pz	h=cm	n° pz
Carlotta	16740760	8001244006621	60	1,22	10	38,5x24x78	38,5x6,5x78	79,5x28,5x40	8	96	135	88

# Paco

## Lo stender bello e servizievole

**Quanto** 70 cm di appendiabiti più un analogo spazio poggiascarpe

**Categoria** Struttura in acciaio, con finiture in resina plastica

**Perché** In casa, in ufficio, in negozio, lo stender si può spostare agevolmente grazie alle 4 ruote piroettanti. Uno spazio extra e un look in sintonia con il gusto di oggi

## A beautiful and helpful clothes-hanging stand

**What size** 70 cm of clothes-hanging bar plus 70 cm of shoe-holder

**Category** Steel construction with plastic resin finishing

**Why** At home, at office, in the store, this clothes-hanging stand can be easily moved thanks to its 4 pivoting wheels. Extra space and very modern look

## Der schöne und nützliche Ständer

**Kapazität** 70 cm langer Kleiderständer und eine entsprechende Schuhablage

**Material** Stahlstruktur, mit Kunstharzprofilen

**Merkmale** Zu Hause, im Büro, im Laden, dank der 4 achsenrotierenden Rollen ist der Ständer bequem umzustellen. Zusätzlicher Platz und ein aktuelles Design

## Un portemanteau vestiaire beau et pratique

**Combien** 70 cm de barre porte-vêtements plus 0 cm de tablette porte-chaussures

**Catégorie** Structure en acier avec finitions en résine plastique

**Pourquoi** À la maison, au bureau, dans le magasin, ce portemanteau vestiaire peut être aisément déplacé grâce aux 4 roues pivotantes. Un espace supplémentaire et un look en ligne avec le goût moderne

## ¡El tendedero bonito y útil!

**Cuánto** 70 cm de barra perchero más un espacio análogo para guardar el calzado

**Categoría** Estructura en acero con acabados en resina plástica

**Porqué** En casa, en la oficina, en la tienda, el tendedero se desplaza con facilidad gracias a sus 4 ruedas giratorias. Espacio extra y un aspecto en sintonía con el gusto actual

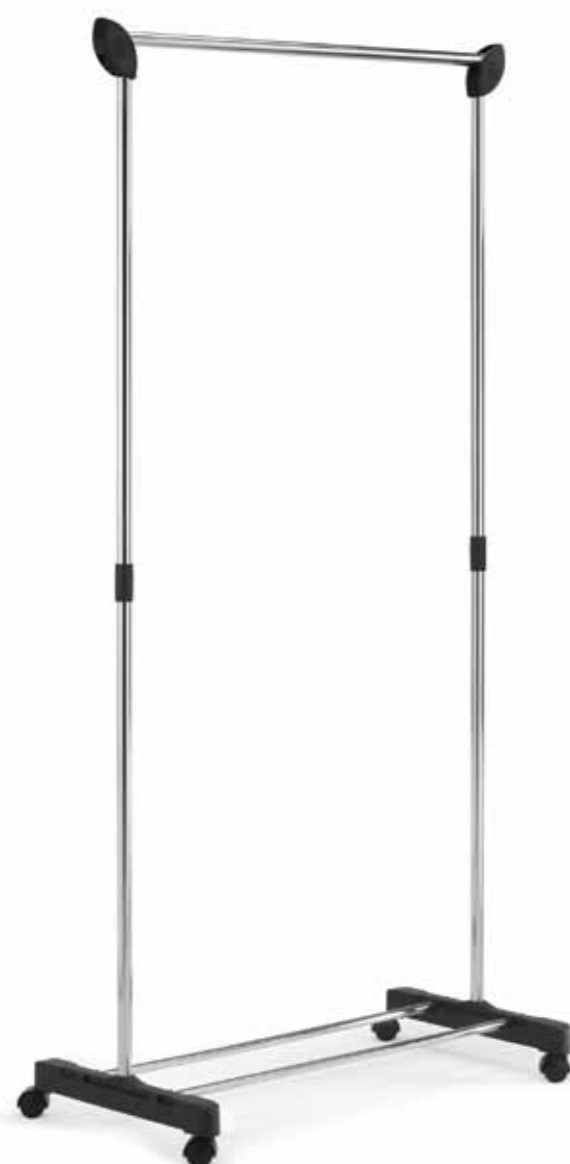

# Super Paco

## L'allegria del colore e l'armonia del coordinato

**Quanto** 130 cm di appendiabiti corredato di 6 attaccapanni più 80 cm di spazio poggiascarpe

**Categoria** Struttura in acciaio, naturale e verniciato, con finiture in resina plastica

**Perché** In ingresso, in camera da letto o nella stanza dei bambini, lo stender si può spostare agevolmente grazie alle 4 ruote piroettanti.

## Lively colours and smart combinations

**What size** 130 cm of clothes-hanging bar with 6 clothes-hangers plus 80 cm of shoe-holder

**Category** Natural and painted steel construction with plastic resin finishing

**Why** In the entrance hall, in the sleeping room or in the children's room, this clothes-hanging stand can be easily moved thanks to its 4 pivoting wheels.

## Die Freude der Farben und die passende Kombination

**Kapazität** 130 cm langer Kleiderständer mit 6 Kleiderhaken, dazu eine 80 cm lange Schuhablage

**Material** Stahlstruktur, natur und lackiert, mit Kunstharzprofilen

**Merkmale** Im Flur, im Schlafzimmer oder im Kinderzimmer, dank der 4 achsenrotierenden Rollen ist der Ständer bequem umzustellen.

## La gaieté des couleurs et l'harmonie des assortiments

**Combien** 130 cm de barre porte-vêtements avec 6 cintres plus 80 cm de tablette porte-chaussures

**Catégorie** Structure en acier naturel et peint avec finitions en résine plastique

**Pourquoi** Dans l'entrée, dans la chambre à coucher, dans la chambre des enfants, ce portemanteau vestiaire peut être aisément déplacé grâce aux 4 roues pivotantes.

## ¡El tendedero bonito y útil!

**Cuánto** 130 cm de barra perchero provista de 6 perchas más 80 cm de espacio para guardar el calzado

**Categoría** Estructura en acero, natural y pintado, con acabados en resina plástica

**Porqué** En el recibidor, en la habitación o en la habitación de los niños, el tendedero se desplaza con facilidad con sus 4 ruedas giratorias.

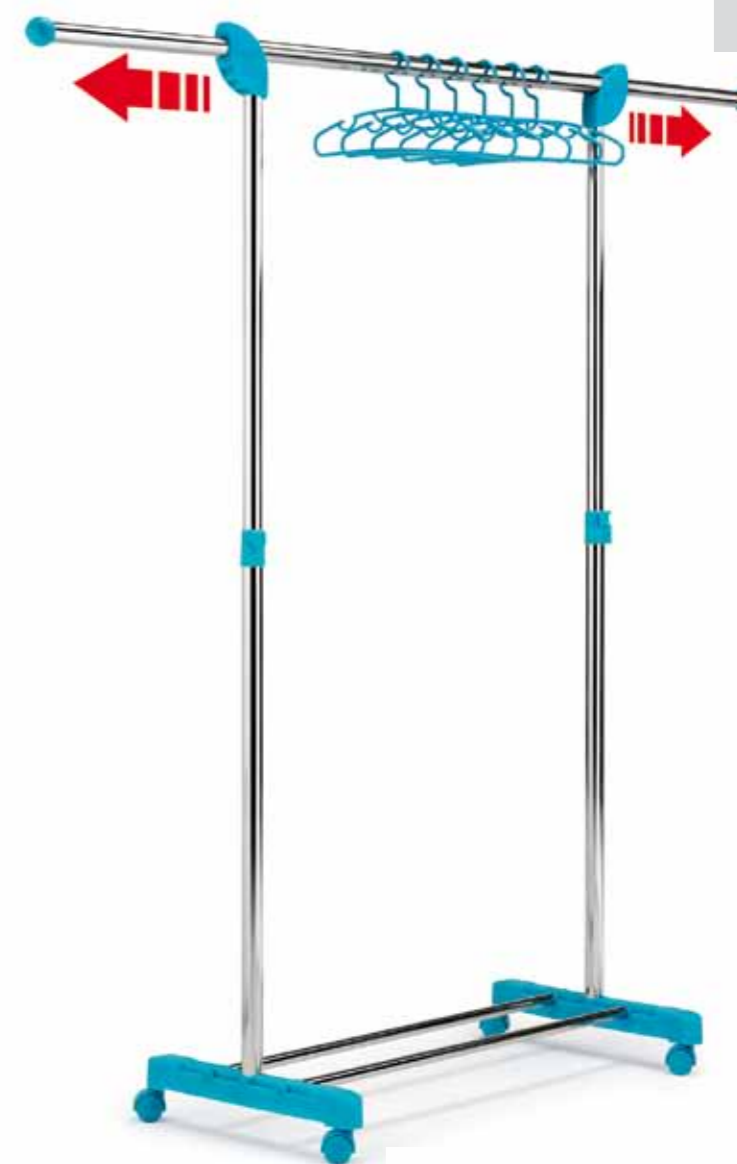

Item	Gimi	Ean	1 pz	kg	axbxc=cm	axbxc=cm	axbxc=cm	n° pz	n° pz	h=cm	n° pz
Paco	17610110	8001244008496	2,32	15	74x43x172	14,5x6x81,5	30,5x20x82	6	96	97	119

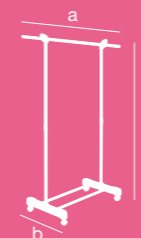

Item	Gimi	Ean	1 pz	kg	axbxc=cm	axbxc=cm	axbxc=cm	n° pz	n° pz	h=cm	n° pz
Super Paco	17610115	8001244008502	3,58	25	147x43x172	22,5x6x88,5	23x36,5x89	6	60	104	80

# Bingo

**Attacca, appendi e stacca ovunque vuoi!**

**Categoria** 100% resina  
**Perché** Appendino a ventosa, facile da applicare, in tanti colori

**Fix, hang up your clothes, go anywhere you want!**

**Category** 100% resin  
**Why** Suction cup clothes hook, easy to apply, available in many colours

**Anbringen, Aufhängen, Abnehmen, einfach überall!**

**Material** 100% Harz  
**Merkmale** Aufhänger mit Saugnapfen in vielen Farben, einfach anzubringen

**Fixez, accrochez et enlevez, où vous souhaitez!**

**Catégorie** 100% résine  
**Pourquoi** Cintre avec ventouse, facile à appliquer, en plusieurs couleurs

**¡Fíjalo, cuélgalo y desplázalo donde deseas!**

**Catégorie** 100% resina  
**Porqué** Percha de ventosa en muchísimos colores, fácil de aplicar



Item	Gimi	Ean	1 pz	kg	Aperto Open		Chiuso Folded		n° pz	n° pz	h=cm	n° pz
					axbxc=cm	axbxc=cm	axbxc=cm	n° pz				
Bingo	17060500	8001244001602	0,05	3	7,5x7,5x7,5	7,5x6,5x15	31,5x23,5x59	96	2304	133	2198	

# Bingo Crystal

**Un prodotto di successo che nella nuova versione trasparente si inserisce in qualunque contesto**

**Quanto** 5 ganci appenditutto

**Categoria** Polistirolo Crystal con ventosa in silicone

**Perché** Non occorre forare pareti o piastrelle: l'aderenza è garantita su tutte le superfici lisce

**A successful product that can fit any environment in its new transparent version**

**What size** 5 multipurpose hanging hooks

**Category** Crystal polystyrene with silicone suction pad

**Why** No need to drill walls or tiles: it adheres to any smooth surface

**Ein erfolgreiches Produkt, das in der neuen durchsichtigen Version in jede Umgebung passt**

**Kapazität** 5 Allzweckhaken

**Material** Styropor Crystal mit Silicon-Saugnapf

**Merkmale** Kein Bohren von Wand und Fliesen: sichere Haftung auf jeder glatten Oberfläche

**Un produit de succès qui, dans sa nouvelle version transparente, s'intègre dans tout milieu**

**Combien** 5 crochets multiusages

**Catégorie** Polystyrène Crystal avec ventouse en silicone

**Pourquoi** Pas de besoin de percer les parois ou les carreaux: l'adhérence est garantie sur toute surface lisse

**Un producto de éxito seguro que en la nueva versión transparente armoniza con cualquier entorno**

**Cuánto** 5 ganchos para colgar de todo

**Categoría** Poliestireno Crystal con ventosa en silicona

**Porqué** No es necesario taladrar paredes ni baldosas: adherencia garantiza en todas las superficies lisas



# Bingo Ministück

**Quanto** 3 inviti portascope e 2 ganci appenditutto

**Categoria** Polistirolo Crystal con ventosa in silicone

**Perché** Ideale in lavanderia, ma si colloca ovunque per tenere in ordine scope, spazzettone, strofinacci

**Kapazität** 3 Besenaufnahmen und 2 Allzweckhaken

**Material** Styropor Crystal mit Silicon- Saugnapf

**Merkmale** Optimal für die Waschküche, jedoch überall zur Aufbewahrung von Besen, Schrubbern, Putzlappen einsetzbar

**Combien** 3 supports porte-balais et 2 crochets multiusages

**Catégorie** Polystyrène Crystal avec ventouse en silicone

**Pourquoi** Idéal dans la buanderie, il peut être utilisé partout pour ranger les balais, les serpillières, les torchons

**Cuánto** 3 sujetaescobas y 2 ganchos para colgar de todo

**Categoría** Poliestireno Crystal con ventosa en silicona

**Porqué** Ideal para lavandería, pero instalable en cualquier sitio para mantener en orden escobas, escobones, trapos

**What size** 3 mop and broom-holders and 2 multipurpose hanging hooks

**Category** Crystal polystyrene with silicone suction pad

**Why** Ideal in the laundry room, it can be used anywhere to organise brooms, handles, mops, floor cloths, dusters



# Super Bingo Crystal

**Una portata ancora maggiore per questa versione potenziata**

**Quanto** 2 ganci appenditutto

**Categoria** Polistirolo Crystal con ventosa in silicone

**Perché** Ideale per accappatoi e grandi asciugamani

**Enhanced version for increased capacity**

**What size** 2 multipurpose hanging hooks

**Category** Crystal polystyrene with silicone suction pad

**Why** Ideal for large towels and bathrobes



# Bingo Stüick

**Quanto** Ben 40 centimetri con 8 ganci appenditutto

**Categoria** Polistirolo Crystal con ventosa in silicone

**Perché** Per non avere più nulla in disordine nel ripostiglio, in cucina, sul fianco di un armadio o dove vuoi tu

**Kapazität** 40 cm mit 8 Allzweckhaken

**Material** Styropor Crystal mit Silicon-Saugnapf

**Merkmale** Keine Unordnung mehr im Abstellraum oder in der Küche, auf einer Schrankseite oder nach Wunsch überall einsetzbar

**Cuánto** hasta 40 centímetros con 8 ganchos para colgar de todo

**Categoría** Poliestireno Crystal con ventosa en silicona

**Porqué** Para evitar desorden en el trastero, en la cocina, en el costado de un armario o donde Ud. quiera

**What size** As many as 40 centimetres with 8 multipurpose hanging hooks

**Category** Crystal polystyrene with silicone suction pad

**Why** Everything will be tidy in the cleaning closet, in the kitchen, on the side of a cabinet, or wherever you like

**Combien** 40 centimètres avec 8 crochets multiusages

**Catégorie** Polystyrène Crystal avec ventouse en silicone

**Pourquoi** Afin que rien ne soit plus ésbordonné dans le débarras, dans la cuisine, sur le flanc d'une armoire ... bref, où vous voulez



**Eine verstärkte Version mit einer noch größeren Tragkraftpasst**

**Kapazität** 2 Allzweckhaken

**Material** Styropor Crystal mit Silicon-Saugnapf

**Merkmale** Optimal für Bademäntel und große Handtücher

**Capacité accrue dans cette version renforcée**

**Combien** 2 crochets multiusages

**Catégorie** Polystyrène Crystal avec ventouse en silicone

**Pourquoi** Idéal pour les peignoirs et les grandes serviettes

**Aún mayor capacidad para esta versión potenciada**

**Cuánto** 2 ganchos para colgar de todo

**Categoría** Poliestireno Crystal con ventosa en silicona

**Porqué** Ideal para colgar albornoces y toallas grandes



Item	Gimi	Ean	1 pz	kg	Aperto / Open		Chiuso / Folded		n° pz	n° pz	h=cm	n° pz
					axbxc=cm	axbxc=cm	axbxc=cm	n° pz				
Bingo Crystal	17061500	8001244008632	0,05	3	7,5x7,5x7,5	7,5x6,5x15	31,5x23,5x59	96	2304	133	2198	
Super Bingo Crystal	17067600	8001244008670	0,06	4	9x9x9	9x8,5x18,5	28,5x19,5x18,5	12	960	107,5	1167	

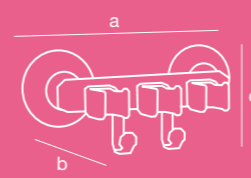

Item	Gimi	Ean	1 pz	kg	Aperto / Open		Chiuso / Folded		n° pz	n° pz	h=cm	n° pz
					axbxc=cm	axbxc=cm	axbxc=cm	n° pz				
Bingo Ministück	17505400	8001244008649	0,18	4	22x10x9,5	19x9x27	29x25,5x39,5	12	576	173	410	
Bingo Stüick	17760500	8001244008663	0,28	5	46x8,5x9,5	19,5x9x50,5	28x49x40,5	12	288	177	215	

# Bingo Pocket

**Un saldo fissaggio che non richiede forature per un accessorio utile in ogni casa**

**Quanto** Contiene 20 sacchetti, con tre ganci per appendere piccoli oggetti come le presine

**Categoria** Polipropilene con ventosa in silicone

**Perché** I sacchetti della spesa sono in ordine e a portata di mano per essere riutilizzati

**Solid attachment with no drilling for a "must" accessory**

**What size** 20-bag capacity with 3 hooks to organise small objects such as pan-holders

**Category** Polypropylene silicone suction pad

**Why** Shopping bags will be tidy and within reach to be easily reused

**Ein für jeden Haushalt nützliches Accessoire mit einer soliden bohrungsfreien Befestigung**

**Kapazität** 20 Säckchen mit drei Haken zum Aufhängen kleiner Gegenstände wie Topflappen

**Material** Polypropylen mit Silicon-Saugnapf

**Merkmale** Die Einkaufstüten werden bequem aufbewahrt und sind leicht wieder verwendbar

**Une fixation solide sans besoin de perçage pour un accessoire incontournable dans toute maison**

**Combien** Capacité de 20 sacs avec 3 crochets pour suspendre de petits objets tels que des poignées

**Catégorie** Polypropylène avec ventouse en silicone

**Pourquoi** Les sacs des courses sont parfaitement rangés et à la portée de la main pour être réutilisés

**Una firme fijación sin taladrar, para disponer de un objeto útil en la casa**

**Cuánto** Contiene 20 bolsas con tres ganchos para colgar pequeños objetos, como agarradores

**Categoría** Polipropileno con ventosa en silicona

**Porqué** Las bolsas de la compra siempre en orden y al alcance de la mano, para su reutilización



# Ap-lik

**L'appenditutto dai mille usi!**

**Categoria** Struttura in resina 100%, ganci in acciaio

**Dove** Per interni

**Perché** indispensabile in ogni casa, può essere fissato sulla parete o sistemato sulla porta; perfetto ovunque grazie all'innovativo design. Vite e tassello inclusi

**The clothes hook you can use for anything!**

**Category** 100% resin body with steel hooks

**Where** Indoors

**Why** Indispensable in any home. It can be fixed to the wall, or behind a door; perfect anywhere thanks to the innovative design. Screw and anchor included

**Aufhängungen zum tausendfachen Gebrauch!**

**Material** Struktur aus 100% Kunststoff, Haken aus Stahl

**Standort** Innen

**Merkmale** In jedem Haushalt unentbehrlich zum Fixieren an Wänden oder Türen; genial für vielfältige Verwendung und Problemlösungen; alles in allem perfekt durch das innovative Design. Schraube und Dübel inbegriffen

**Pour accrocher n'importe quoi!**

**Catégorie** Structure en résine 100%, crochets en acier

**Où** A l'intérieur

**Pourquoi** Indispensable pour chaque habitation. Ce modèle peut être fixé au mur ou sur une porte. Il est parfait partout grâce à son design innovant. Vis et boulon de fixation inclus

**¡El cuelga-todo de mil usos!**

**Categoría** Estructura de resina 100%, ganchos de acero

**Dónde** Para interiores

**Porqué** Indispensable para todas las casas, puede fijarse en la pared o colocarse en la puerta; perfecto dondequiera que sea gracias a su diseño innovador. Se incluyen tornillos y tacos



Item	Gimi	Ean	1 pz	kg	axbxc=cm	axbxc=cm	axbxc=cm	n° pz	n° pz	h=cm	n° pz
Bingo Pocket	17630500	8001244008656	0,28	3,5	12x7,5x39	12,5x8x43	23,5x39x25,5	6	240	117	256

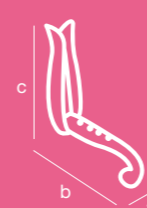

Item	Gimi	Ean	1 pz	kg	axbxc=cm	axbxc=cm	axbxc=cm	n° pz	n° pz	h=cm	n° pz
Ap-lik	17030400	8001244703049	0,38	10	7,5x26x26	19x10x37,5	35,5x24x39	12	480	171	361



Nome prodotto Item	Plus		
	Esclusiva Gimi Gimi exclusive	Scomparti Compartment	Altro Other
Nature Plus 1	✓	1	griglia inferiore supporting grid
Nature Plus 2	✓	2	griglia inferiore supporting grid
Nature Plus 3	✓	3	griglia inferiore supporting grid
Nature 1		1	
Nature 2		2	
Nature 3		3	

## Completo di griglia in acciaio

**Categoria** Struttura in acciaio e coperchio in resina bicolore, riciclabili al 100%

**Dove** In giardino, in garage, sul terrazzo

**Quanto** Accoglie uno, due o tre sacchi standard (cm 65 x 105 circa)

**Perché** Per raccogliere separatamente vetro, metallo, plastica, carta, erba e ramaglie. Completo di griglia in acciaio a sostegno del peso del sacco pieno

## Complete with a steel grid

**Category** 100% recyclable steel body and bicolour resin cover

**Where** Gardens, garages, terraces

**What size** It can be used with one, two or three standard bags (about 65 x 105 cm)

**Why** Separate collection of glass, metal, plastics, paper, grass and branches. Complete with a steel grid to support the full bag



**Nature Plus 3**



**Nature Plus 1**



**Nature Plus 2**

## Mit Stahlrost

**Material** Stahlrahmen und Deckel aus zweifarbigem Kunststoff, 100% wieder verwertbar

**Standort** Im Garten, in der Garage, auf dem Balkon

**Umfang** Platz für einen, zwei oder drei Standard-Säcke (ca. 65 x 105 cm)

**Merkmale** Zur getrennten Lagerung von Glas, Metallen, Kunststoff, Papier, Gras und Reisig. Mit Stahlrost um den vollen Sack zu unterstützen

## Avec grille en acier

**Catégorie** Corps en acier et couvercle en résine bicolore, entièrement recyclables

**Où** Jardins, garages, terrasses

**Combien** Il peut être utilisé avec un, deux ou trois sacs (environ 65 x 105 cm)

**Pourquoi** Collecte sélective de verre, de métaux, de plastique, de papier, d'herbe et de ramilles. Avec grille en acier pour soutenir le sac plein

## Incluye rejilla de acero

**Categoría** Estructura en acero y tapa de resina bicolor, reciclables al 100%

**Dónde** En el jardín, en el garaje o en la terraza

**Cuánto** Acoge una, dos o tres bolsas estándar (aprox. 65 x 105 cm)

**Porqué** Porque recoge selectivamente cristal, metal, plástico, papel, hierba y ramas. Incluye rejilla de acero para sostener la bolsa llena

BREVETTATO  
PATENTED



Item	Gimi	Ean	kg	axbxc=cm	axbxc=cm	axbxc=cm	n° pz	n° pz	h=cm	n° pz	Kg		Aperto Open	Chiuso Folded
											Aperto Open	Chiuso Folded		
Nature Plus 1	16530102	8001244009783	1,61	37,5x40x82	37,5x4x89,5	39,5x17x91	5	120	197	81				
Nature Plus 2	16530202	8001244009806	2,54	71,5x40x82	71,5x4x89,5	73x17x91	5	60	197	44				
Nature Plus 3	16530302	8001244009820	3,76	105,5x40x82	105,5x4x89,5	108,5x17x91	5	25	106	29				

# Nature

## La raccolta differenziata secondo gimi

**Categoria** Struttura in acciaio e coperchio in resina bicolore, riciclabili al 100%

**Dove** In giardino, in garage, sul terrazzo  
**Quanto** Accoglie uno, due o tre sacchi standard (cm 65 x 105 circa)

**Perché** Per raccogliere separatamente vetro, metallo, plastica, carta, erba e ramaglie

## Separate collection according to gimi

**Category** 100% recyclable steel body and bicolour resin cover

**Where** Gardens, garages, terraces  
**What size** It can be used with one, two or three standard bags (about 65 x 105 cm)

**Why** Separate collection of glass, metal, plastics, paper, grass and branches



Nature 3



Nature 1



Nature 2

## Selektives Sortieren von Gimi

**Material** Stahlrahmen und Deckel aus zweifarbigem Kunststoff, 100% wieder verwertbar

**Standort** Im Garten, in der Garage, auf dem Balkon

**Umfang** Platz für einen, zwei oder drei Standard-Säcke (ca. 65 x 105 cm)

**Merkmale** Zur getrennten Lagerung von Glas, Metaller, Kunststoff, Papier, Gras und Reisig

## La collecte sélective selon gimi

**Catégorie** Corps en acier et couvercle en résine bicolore, entièrement recyclables

**Où** Jardins, garages, terrasses

**Combien** Il peut être utilisé avec un, deux ou trois sacs (environ 65 x 105 cm)

**Pourquoi** Collecte sélective de verre, de métaux, de plastique, de papier, d'herbe et de ramilles

## La recogida selectiva de basura según gimi.

**Categoría** Estructura en acero y tapa de resina bicolor, reciclables al 100%

**Dónde** En el jardín, en el garaje o en la terraza

**Cuánto** Acoge una, dos o tres bolsas estándar (aprox. 65 x 105 cm)

**Porqué** Porque recoge selectivamente cristal, metal, plástico, papel, hierba y ramas



Aperto  
Open

Chiuso  
Folded



Item	Gimi	Ean	kg	axbxc=cm	axbxc=cm	axbxc=cm	n° pz	n° pz	h=cm	n° pz
Nature 1	16530100	8001244007444	1,40	37,5x40x82	37,5x4x89,5	39,5x17x91	6	144	197	98
Nature 2	16530200	8001244007451	2,13	71,5x40x82	71,5x4x89,5	73x17x91	6	72	197	53
Nature 3	16530300	8001244007468	2,85	105,5x40x82	105,5x4x89,5	108,5x17x91	6	30	106	35

# Qualità Gimi.

## Innovazione e design

Gimi investe in ricerca sia per individuare i bisogni insoddisfatti del consumatore, sia per sviluppare prodotti innovativi. Brevetti esclusivi di vario tipo testimoniano questo impegno, tutelando la creatività dei nostri progettisti e il tratto estetico dei nostri designer.



## Gimi's Quality.

### Innovation and Design

Gimi makes investments in research in order to identify unsatisfied needs and develop innovative products. This commitment is proven by many unique patents that protect the creativity of our designers and their aesthetic value.

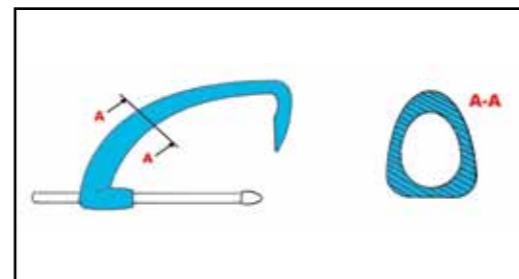

## Qualità dei materiali

Gimi sceglie i materiali più affidabili e performanti, come ad esempio l'acciaio, l'alluminio anodizzato, i polimeri plastici carichi e non, tutti materiali riciclabili al 100%.

Le materie prime, i semilavorati, i componenti, nonché i prodotti finiti sono sottoposti a test di conformità secondo le metodologie più rigorose.

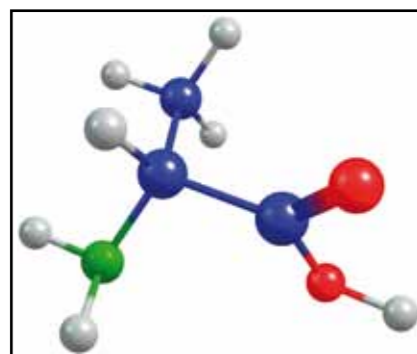

## Quality of Materials

Gimi chooses the most performing and reliable materials such as steel, anodised aluminium, charged and uncharged plastic polymers, all these materials are 100% recyclable.

Raw materials, semi-finished products, components and finished products must successfully pass compliance tests performed according to the strictest methodologies.



## Tecnologie produttive

Gimi eccelle per la modernità e l'unicità del suo sistema produttivo altamente automatizzato, garanzia di ripetibilità dello standard qualitativo: dal "doppio bloccaggio" dei fili in alluminio agli snodi di chiusura senza rivetti, dal doppio rivestimento antiruggine (elettrolitico e rivestimento a polveri epossidiche) alla tecnologia al nitrogeno che inietta il polimero insieme ad un soffio di azoto, esempi di eccellenza tecnologica che si traduce in evidenti vantaggi per il consumatore.

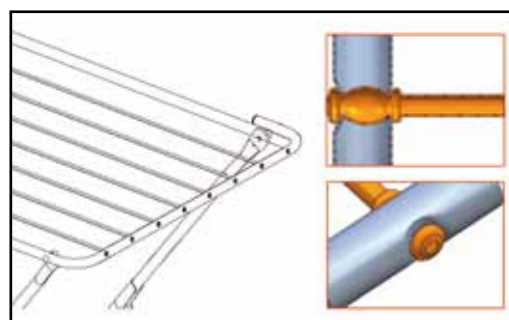

## Manufacturing Technologies

Gimi sets an example of excellence in terms of modernity and uniqueness of its highly automated manufacturing system, which is a guarantee of repeatability of its quality standards. "Double blocked" aluminium lines, unriveted hinges, double antirust covering (electrolytic and epoxy powder covering), nitrogen technology (whereby polymers are injected with a puff of nitrogen): these are all examples of technological excellence that turns into concrete advantages for consumers.

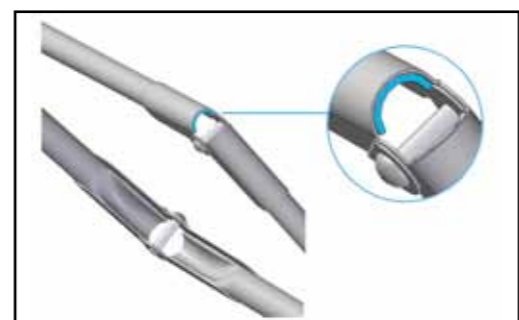

## Rispetto dell'ambiente

I materiali, i processi produttivi, i prodotti sono compatibili con il rispetto dell'ambiente.

La certificazione UNI EN ISO 14001 è per Gimi un traguardo raggiunto da tempo, cui si aggiunge la crescente autonomia energetica basata su moderni impianti di cogenerazione.

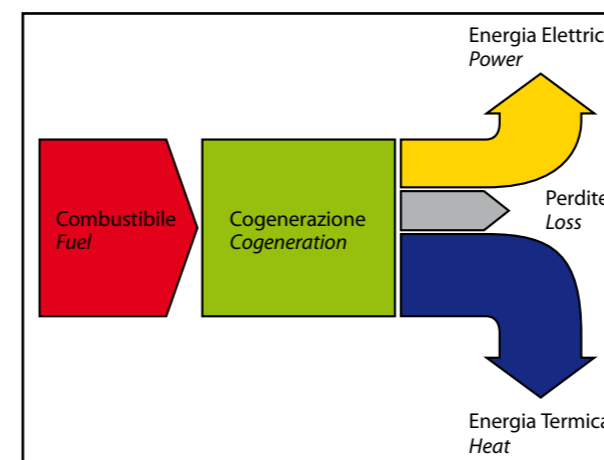

## Respect for the Environment

Materials, manufacturing processes and products are all environmentally friendly.

For Gimi, the UNI EN ISO 14001 certification is a goal achieved a long time ago. Now the company is increasingly autonomous from the point of view of energy provision thanks to its modern cogeneration plants.



## Sicurezza

La sicurezza delle persone è un tema importante per Gimi, sia che lavorino presso i nostri impianti sia che utilizzino i nostri prodotti. Questi ultimi a partire dalla loro progettazione rispondono alle più severe normative internazionali di riferimento.

## Safety

The safety of people is a very important issue for Gimi with reference to both its staff and users of its products, which from as early as their design stage comply with the strictest international reference standards.

## Servizio al cliente

Gimi lavora ogni giorno in quest'ottica attraverso una relazione di reciproco scambio basata su valori come affidabilità, velocità, puntualità, flessibilità. La soddisfazione del cliente è un obiettivo quotidiano al quale concorrono tutte le funzioni aziendali, ciascuna nel suo ambito.

## Service to Customers

Gimi works every day in this spirit through mutual exchanges based on values such as reliability, responsiveness, timeliness, and flexibility. The satisfaction of customers is a goal to be achieved on a daily basis with the cooperation of all corporate functions, each of them in its field of competence.





# Nytrogen technology



## Tecnologia evoluta per l'uso quotidiano.

La resina plastica è la materia prima che ha rivoluzionato la produzione industriale degli ultimi 60 anni, abbassando il costo degli oggetti di uso comune, rendendone possibile la diffusione su larghissima scala.

Oggi è più che mai attuale e Gimi la utilizza per realizzare parti di prodotto o prodotti interi come Perla. Nel caso degli stendibiancheria in resina gimi ha ovviato alla cedevolezza delle parti di grandi dimensioni come il profilo della griglia o le gambe a cavalletto adottando una tecnologia innovativa: attraverso un soffio di azoto a bassissima temperatura (-20°C) durante la fase di iniezione si svuotano dall'interno le cavità chiuse rendendole eccezionalmente resistenti alla flessione e alla torsione.

Il marchio Nitrogen Technology rappresenta questo processo: la forza dell'azoto - raffigurato da un omino stilizzato - espande e sostiene la struttura che attraversa in modo definitivo.

## Technologie de pointe pour un usage quotidien.

La résine plastique est la matière première qui a révolutionné la production industrielle durant ces six dernières décennies, en réduisant le coût des objets à usage domestique et en permettant leur diffusion à très grande échelle.

Aujourd'hui, la résine est très tendance et Gimi l'utilise dans la fabrication de certaines parties de ses produits ou des produits entiers comme le séchoir «Perla». Dans le cas des séchoirs en résine, Gimi a résolu le problème de la taille des grandes pièces comme le profil de la grille ou les jambes repliables grâce à une technologie innovante: une injection d'azote à très basse température (-20°C) pendant la phase d'injection qui vide l'intérieur des cavités fermées, ce qui les rend exceptionnellement résistantes à la flexion et à la torsion.

Les produits ayant bénéficié de ce processus appelé Nitrogen Technology sont repérables par un logo représentant un petit homme stylisé. Ce petit homme symbolise la force de l'azote qui renforce la structure.

## Evolved technology for daily use.

Plastic resin is the raw material that has revolutionised industrial production of the last 60 years, lowering the production costs of items in everyday use and making it possible to distribute them on a large scale.

Today it is all the more topical because it can be recycled 100%. Gimi uses Nitrogen Technology to make product parts or entire products such as Perla. In the case of the resin clothes dryers, Gimi has removed the suppleness of the larger parts such as: the profile of the grid and the folding legs by adopting an innovative technology, which by blowing nitrogen at a very low temperature (-20°C) during the injection phase empties the closed cavities from the inside, making them exceptionally resistant to bending and twisting.

This process is identified by the brand name Nitrogen Technology: the strength of nitrogen - depicted by a stylised man - expands and supports the structure through which it passes.

## Tecnología evolucionada para el uso cotidiano.

La resina plástica es la materia prima que ha revolucionado la producción industrial de los últimos 60 años, reduciendo el costo de objetos de uso común y permitiendo su difusión a gran escala. Hoy, más actual que nunca, Gimi la utiliza para realizar partes de producto o productos completos, como Perla. En el caso de tendederos de resina, Gimi ha eliminado la maleabilidad de las partes de grandes dimensiones, como el perfil de la rejilla o las patas plegables, adoptando una tecnología innovadora, la cual a través del soplo de nitrógeno a muy baja temperatura (-20°C) durante la etapa de inyección vacía desde la parte interna las cavidades cerradas, convirtiéndolas en excepcionalmente resistentes tanto a la flexión como a la torsión.

La marca Nitrogen Technology representa este proceso: la fuerza del nitrógeno - representada por un hombrecito estilizado - expande y sostiene, en modo definitivo, la estructura que atraviesa.

## Neuentwickelte Technologie für den täglichen Gebrauch.

Kunstharz ist ein Rohstoff, der die Industrieproduktion in den letzten 60 Jahren revolutioniert und die Kosten so stark gesenkt hat, dass unzählig viele Gegenstände verbreitet und für den täglich Gebrauch unentbehrlich wurden.

Diese Technologie ist heutzutage umso aktueller und wird von Gimi zur Herstellung einiger Produktteile oder für Produkte wie Perla angewandt. Bei den Wäschetrocknern aus Harz, hat gimi zudem das Problem der Nachgiebigkeit der großen Teile - wie im Falle des Gitterprofils oder der Kippständer - durch eine innovative Technik gelöst: Das Einspritzen von flüssigem Stickstoff bei sehr niedriger Temperatur (-20°C) während der Injektion, leert die geschlossenen Hohlräume von innen, so dass das Material äußerst biege- und torsionsfest wird.

Dieser Prozess ist unter dem Markennamen Nitrogen Technology bekannt: Die Kraft des Stickstoffs - durch das stilisierte Männlein dargestellt - erweitert und unterstützt die Struktur durch und durch endgültig.

## Prodotti/product Nitrogen Technology:

Perla

Duplo

Brezza

Ghibli

Airy

My Porter

Tris

Ap-lik



Un sito web ricco di informazioni e facile da navigare, in italiano, inglese, tedesco, francese, spagnolo, russo.

Full of information and easy to surf web site, in Italian, English, French, Spanish, Russian.

Eine Web-Seite, reich an Informationen und leicht zu bedienen, in italienisch, englisch, deutsch, französisch, spanisch, russisch.

Un site web facile à consulter, avec beaucoup d'informations et traduit dans plusieurs langues (italien, anglais, allemand, français, espagnol, russe).

Una página Web, rica en informaciones y fácil de navegar, en italiano, inglés, alemán, francés, español y ruso.



www.gimi.it

# Indice

## Stendere

### Drying / Aufhängen / Sécher / Extender

Airy	p.	50
Alablock	p.	47
Alablock Extend.	p.	25
Albatross	p.	28
Aster	p.	11
Brezza 100	p.	42
Brezza 100 Alu	p.	43
Brezza 100 Inox.	p.	43
Brezza 200	p.	43
Brezza 60	p.	42
Brezza Extend	p.	26
Brio Super	p.	55
Cigno	p.	65
Cover 400	p.	66
Cucciolo	p.	20
Dinamik 20	p.	32
Dinamik 30	p.	33
Dinamik 30 Color <b>NEW</b>	p.	34
Duplo	p.	35
Extension	p.	30
Garden	p.	61
Ghibli	p.	44
Gocciolo	p.	63
Jolly	p.	5
Lampo	p.	49
Lift	p.	58
Max Inox	p.	12
Mistral	p.	41
Mito	p.	15
Modular 3	p.	38
Modular 4	p.	39
Pallino	p.	48
Perla	p.	22
Plast	p.	5
Pliko	p.	51
Plus	p.	8
Polar	p.	41
Quick	p.	49
Ring	p.	46
Rainbow	p.	9
Rainbow Color <b>NEW</b>	p.	9
Rocky	p.	10
Rotor 1	p.	53
Rotor 4	p.	54
Rotor 6	p.	54
Skatto	p.	56
Soffio	p.	64
Stendissimo	p.	27
Telepack	p.	57
Tempo	p.	16
Tempo Color <b>NEW</b>	p.	17
Tempo Super	p.	18
Tender	p.	13
Tender Color <b>NEW</b>	p.	14
Tendy	p.	67
Top	p.	6
Top Super	p.	7
Unix	p.	59
Vip 3	p.	37
Vip 4	p.	37
Virgola	p.	45
Zaffiro	p.	21

## Stirare

### Ironing / Bügeln / Repasser / Planchar

Advance 100 <b>NEW</b>	p.	85
Advance 120 <b>NEW</b>	p.	86
Advance 140 <b>NEW</b>	p.	87
Andy <b>NEW</b>	p.	72
Classic	p.	74
Eden	p.	77
Golden	p.	81
I Love Gimi	p.	90
Joker	p.	89
Junior	p.	73
Leo <b>NEW</b>	p.	70
King Aluminium	p.	89
Mitiko	p.	82
Planet	p.	103
Poker	p.	80
Pollicino	p.	69
Prestige	p.	76
Prisma	p.	83
Roy <b>NEW</b>	p.	71
Stiro Fast <b>NEW</b>	p.	98
Stiro Soft <b>NEW</b>	p.	99
Stiro Strong <b>NEW</b>	p.	97
Stiro Top <b>NEW</b>	p.	100
Temper	p.	79
Trim	p.	75
Uniko	p.	78
Wrappy	p.	102

## Portare pesi

### Carrying weights / Schwere gewichte tragen / Porter des poids / Transportar la compra

Alex	p.	121
Argo	p.	106
Atos	p.	120
Bella	p.	105
Brava	p.	105
Easy	p.	108
Extro	p.	110
Family	p.	111
Fly School	p.	118
Four 4	p.	116
Ideal	p.	109
Market	p.	112
My Porter	p.	113
Tris	p.	114
Ulysse	p.	115

## Salire

### Climbing / Steigen / Monter / Subir

Dune	p.	127
Super Tiko	p.	124
Tiko	p.	123

## Le idee - Portarifiuti

### Ideas - Waste management system

### Ideen - Abfallsammler / Les ideas - Poubelle "porte-sachet"

### Las ideas - Contenedor de basuras selectivas

Ap-lik.	p.	137
Bingo	p.	132
Bingo Crystal	p.	134
Bingo Ministick	p.	135
Bingo Pocket	p.	136
Bingo Stick	p.	135
Carlotta	p.	129
Nature	p.	140
Nature Plus	p.	139
Paco	p.	130
Super Bingo Crystal	p.	134
Super Paco	p.	131